

Reclining Wheelchair Backrest

PATENT No. 5,865,504
AND PATENT PENDING

Reorder #	Chair Width	Reorder #	Chair Width	Reorder #	Chair Width	Backrest Height
703101	18"	703111	16"	703105	20"	19"
703102	18"	703112	16"	703106	20"	24"
703103	18"	703113	16"	703107	20"	33"

PURPOSE

The Reclining Wheelchair Backrest converts any standard 16-inch-, 18-inch-, or 20-inch-wide wheelchair to a reclining-back wheelchair. It is designed to provide up to 20 degrees of tilt. The backrest is available in three heights: 19 inches which provides no head support; 24 inches which provides head support for residents of short to medium stature; and, 33 inches which provides head support for tall residents.

WARNING

Skil-Care's Reclining Wheelchair Backrest should be used only on wheelchairs equipped with amputee adaptors or anti-tipping devices. Wheelchairs not equipped with these adaptors or devices may tip over backwards. Amputee adaptors and anti-tipping devices are available from your local wheelchair dealer or wheelchair parts supplier.

INSTALLATION INSTRUCTIONS

(Tools required: Phillips screwdriver, slot screwdriver.)

1. Equip wheelchair with either an amputee adaptor or anti-tipping device. (See warning above.)

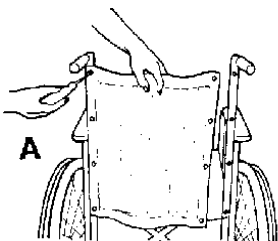

2. Remove existing backrest. This is done by removing the eight screws that secure the backrest to the wheelchair frame. Do not discard screws. Two of them will be needed to install Reclining Backrest. (See Illustration A.)

3. Loop Backrest support belt over wheelchair pushhandles. The support belt is properly positioned if the grommets on the left and right sides and the belt adjuster are facing away from the wheelchair. Align grommets with screw holes on the top left and right sides of the wheelchair frame. Insert screws through grommets, into screw holes, and tighten. (See Illustration B.)

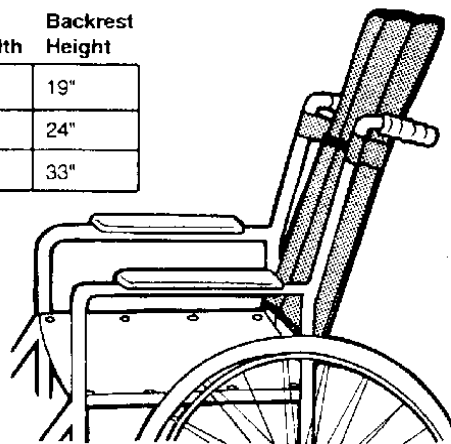
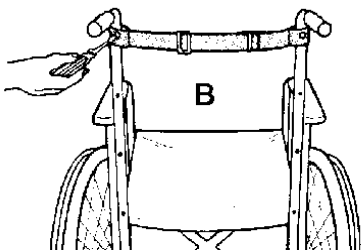

4. Loosen one screw on each of the two clamps. Open the clamps. (See Illustration C.)

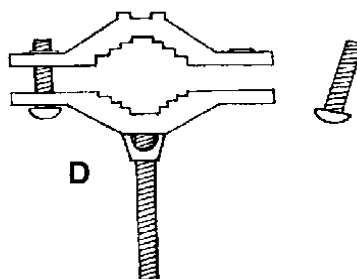
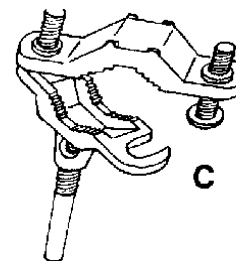

5. Remove one screw from one clamp. (See illustration D.) This clamp and screw will be used in step 7.

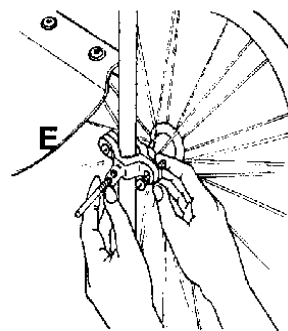

6. Place one clamp on either the left or right side of the wheelchair frame approximately three inches below the seat, (See illustration E.) Tighten screws enough so that clamp stays in place, but not so tight as to prevent clamp from moving when hand pressure is applied. You will need to be able to move and adjust clamp before final installation is accomplished.

(See Reverse Side)

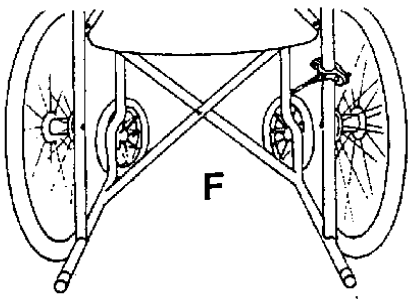

7. Angle the clamp so that the rod points slightly away from the wheelchair. (See illustration F.)

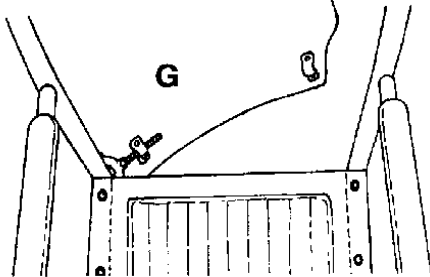

8. Position reclining backrest in front of the support belt and align bracket at bottom of backrest with the rod extending from the attached clamp. Slide backrest bracket onto the rod. (See illustration G.) Slide the rod from second clamp into other backrest bracket and position clamp around wheelchair frame. (See illustration H.) Insert screw removed in step 5. Tighten screws to snug fit. Adjust both clamps so that backrest is level and aligned with wheelchair seat. Tighten all screws securely after backrest is properly positioned. (See illustration I.)

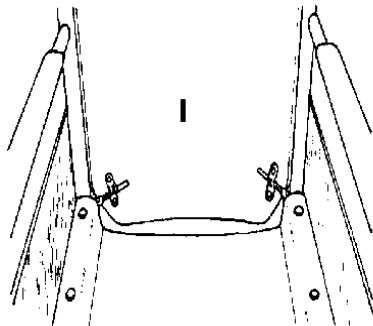
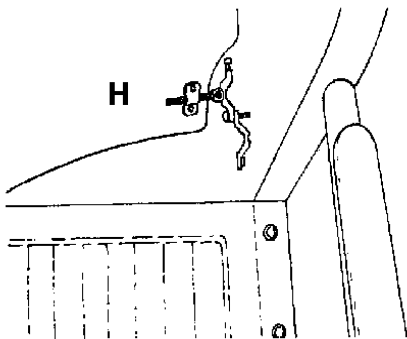

ADJUSTING THE BACKREST TO YOUR RESIDENT'S NEEDS

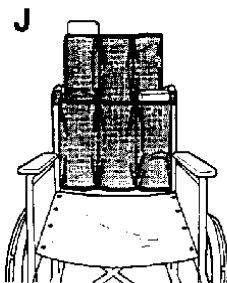

The six compartments in the backrest's vinyl cover are designed to hold foam pads. These pads are included. The foam pads may be added or removed from the compartments so that the backrest can be adjusted to meet the alignment needs of each resident. The compartments may also be used to hold hot or cold packs. (See illustration J.)

The degree of tilt may be controlled by means of the belt adjuster on the backrest support belt. The backrest will provide up to 25 degrees of tilt. (See illustration K.)

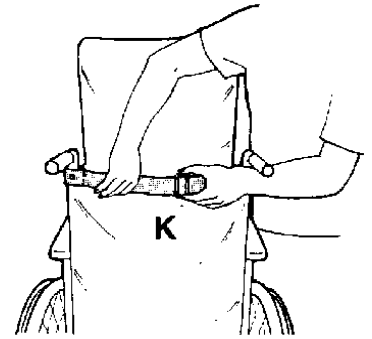

CLEANING THE BACKREST

The backrest may be cleaned using any spray cleanser and a damp cloth or sponge.

OPTIONAL ACCESSORIES

Available from your Skil-Care dealer.

Headrest

(See Illustration L.)

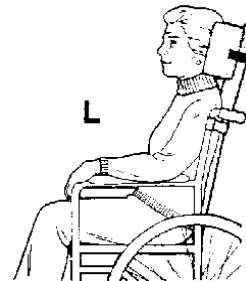

Laterally stabilizes the resident's head and places it in a position that promotes forward eye contact. The headrest raises and lowers easily and secures to the backrest by means of a strap with an easy-release buckle. Fits both 16-inch- and 18-inch-wide wheelchairs. Available in three depths (see below). Cloth cover is launderable.

Reorder #	Depth	Chair Width
703115	3"	16" & 18"
703116	3¾"	16" & 18"
703117	4¾"	16" & 18"

Armrest Pads

(See Illustration M.)

Provides foam-padded cushioning for the full length of the wheelchair arms. Covered with durable nylon, these launderable pads remove easily for laundering. Available for both full-arm and half-arm wheelchairs.

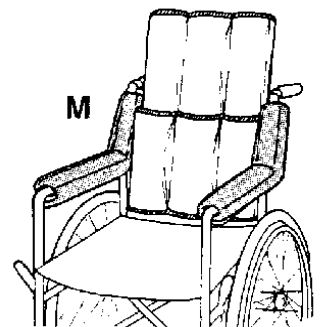

Reorder #	Description	Unit
703130	Full-Arm Wheelchair (16")	Pair
703131	Half-Arm Wheelchair (11")	Pair

Important Notice about using Alarm Cushion with Skil-Care's Reclining Wheelchair Backrest

The alarm box mounting bracket packaged with the Alarm Cushion should not be used if your wheelchair is fitted with Skil-Care's Reclining Backrest. A special mounting bracket is required. You may obtain one at no cost by calling the Skil-Care customer service desk at 1-800-431-2972 (914-963-2040 in New York) and requesting the **clip-on alarm box mounting bracket** for use with the reclining backrest.