

IV Sets and Access Devices Product Catalog

Effective June 2023



Contents

Stopcocks and Manifolds1-2

Anesthesia Extension Sets 3-5

Anesthesia IV Administration Sets. 6-7

Blood Administration Sets. 8-9

Basic IV Administration Sets10

Extension Sets10-11

CARESAFE™ IV Administration
Sets and Extension Sets12-13

STEADYCare™ Extension Sets.14

Rate Flow® Regulator II Administration Sets.15

Syringe Pump PE-Lined Fluid Path
Microbore Extension Sets16

Filtered Extension Sets16

Measured Volume Solution Burette Sets.17

Special Application Accessories17

Injection Caps and Replacement Caps18

CARESITE® Luer Access Device (LAD) System . 19-23

 CARESITE Extension Sets.19-22

 CARESITE Administration Sets. 22-23

 CARESITE Blood Administration Sets. 23

SAFELINE® Needleless System24-27

 SAFELINE Extension Sets. 24-25

 SAFELINE IV Administration Sets. 25-26

 SAFELINE Injection Site and Accessories.27

InVision-Plus® Needleless Connector
with Neutral Advantage Technology 28

STOPCOCKS AND MANIFOLDS

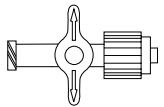
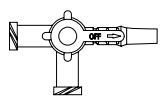
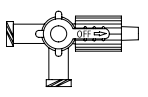
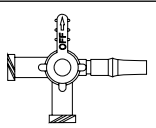
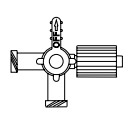
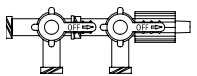
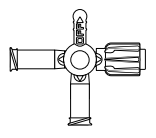
Description	Product Code	REF Number	Unit Per cs
DISCOFIX® Stopcocks			
 <p>One-way stopcock with female luer lock port and SPIN-LOCK® connector. Not made with DEHP or natural rubber latex. Priming volume: 0.20 mL Length: 1 in. (2.54 cm)</p>	D100	455980	100
 <p>3-way stopcock with two female luer lock ports and male luer slip connector. Not made with DEHP or natural rubber latex. Priming volume: 0.26 mL Length: 1 in. (2.54 cm)</p>	D201	455991	100
 <p>3-way stopcock with two female luer lock ports and SPIN-LOCK® connector. Not made with DEHP or natural rubber latex. Priming volume: 0.26 mL Length: 1 in. (2.54 cm)</p>	D300	456003	100
 <p>4-way stopcock with two female luer lock ports and male luer slip connector. Not made with DEHP or natural rubber latex. Priming volume: 0.26 mL Length: 1 in. (2.54 cm)</p>	D401	456006	100
 <p>4-way stopcock with two female luer lock ports and SPIN-LOCK® connector. Not made with DEHP or natural rubber latex. Priming volume: 0.26 mL Length: 1 in. (2.54 cm)</p>	D500	456020	100
 <p>2-gang, 3-way stopcocks with 3 female luer lock ports and SPIN-LOCK® connector. Not made with DEHP or natural rubber latex. Priming volume: 0.86 mL Length: 3 in. (7.62 cm)</p>	D201T	455992	100
 <p>High-Flow, four-way stopcock, two female luer lock ports and SPIN-LOCK connector, port covers. Not made with DEHP or natural rubber latex. Priming volume: 0.32 mL</p>	D600	456061	100

Description	REF Number	Unit Per cs
-------------	------------	-------------

ULTRAPORT Zer0™ and ULTRAPORT™ Luer-Activated Stopcocks

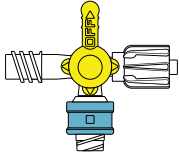

High-flow, four-way stopcock with luer-activated ULTRAPORT Zer0™ port, female luer lock port and SPIN-LOCK® connector. Not made with DEHP or natural rubber latex. Max pressure: 29 psi (2 bar). Stopcock volume 0.4 mL. 456064 100

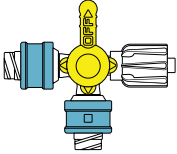

High-flow, four-way stopcock with two luer-activated ULTRAPORT ports, and SPIN-LOCK connector. Not made with DEHP or natural rubber latex. Max pressure: 29 psi (2 bar). Stopcock volume: 0.4 mL. 456065 100

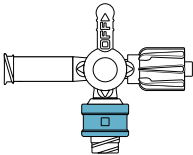

High-flow, four-way stopcock with luer-activated ULTRAPORT™ port, female luer lock port and SPIN-LOCK® connector. Max pressure: 29 psi (2 bar). Not made with DEHP or natural rubber latex. Max pressure: 29 psi (2 bar). Valve port volume: 0.1 mL. Stopcock volume 0.5 mL. 456066 100

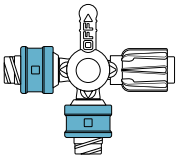

High-flow, four-way stopcock with two luer-activated ULTRAPORT™ ports, and SPIN-LOCK connector. Not made with DEHP or natural rubber latex. Max pressure: 29 psi (2 bar). Valve port volume: 0.1 mL. Stopcock volume 0.4 mL. 456063 100

Manifolds

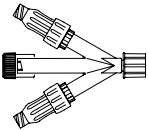

Tri-Connector with female Luer Lock Connector, two bonded CARESITE® Luer Access Devices, and Spin-Lock® Connector. Not made with DEHP or natural rubber latex. Priming volume: 1.3 mL, Length: 2.5 in. (6.35 cm)

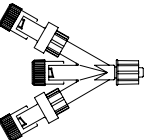



Tri-Connector with two bonded normally closed backcheck valves, and Spin-Lock adapter. Not made with DEHP or natural rubber latex. Priming volume: 1.14 mL, Length: 2.5 in. (6.35 cm)

■ ULTRAPORT Zer0™ Stopcock ■ Needleless Valve (ULTRAPORT / ULTRAPORT Zer0™)

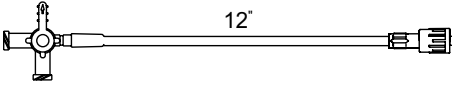
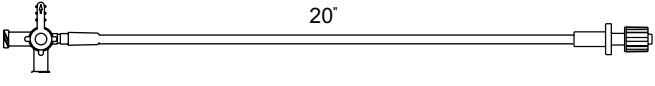
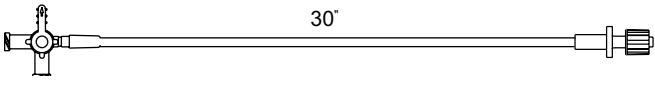
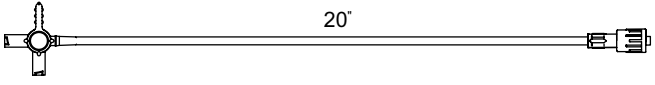
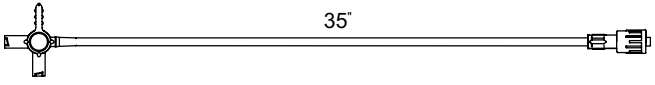
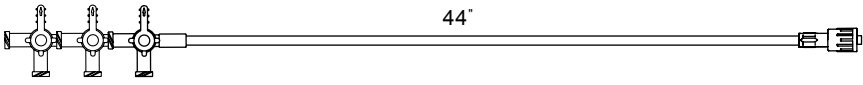
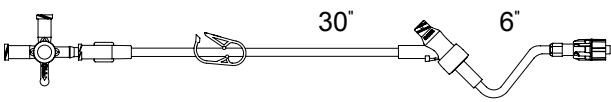
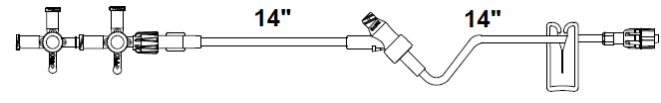
ANESTHESIA EXTENSION SETS

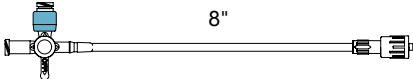
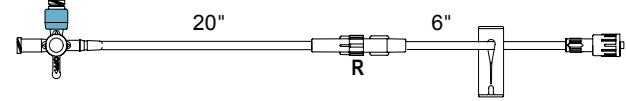
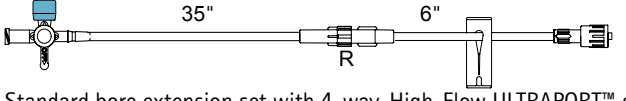
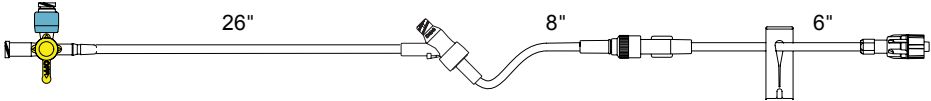
Description	REF Number	Unit Per cs
Open Lumen Stopcocks		
 <p>Standard bore extension set with 4-way open lumen stopcock, and SPIN-LOCK connector. Not made with DEHP or natural rubber latex. Priming volume: 1.4 mL, Length: 14 in. (35.5 cm)</p>	454320	100
 <p>Standard bore extension set with 4-way open lumen stopcock, and SPIN-LOCK connector. Not made with DEHP or natural rubber latex. Priming volume: 1.8 mL, Length: 23 in. (58 cm)</p>	456025	50
 <p>Standard bore extension set with 4-way open lumen stopcock, and SPIN-LOCK connector. Not made with DEHP or natural rubber latex. Priming volume: 2.6 mL, Length: 35 in. (89 cm)</p>	456030	50
 <p>Standard bore extension set with 4-way, High-Flow open lumen stopcock, and SPIN-LOCK connector. Not made with DEHP or natural rubber latex. Priming volume: 3.5 mL, Length: 22 in. (56 cm)</p>	473541	50
 <p>Standard bore extension set with 4-way, High-Flow open lumen stopcock, and SPIN-LOCK connector. Not made with DEHP or natural rubber latex. Priming volume: 5.9 mL, Length: 37 in. (94 cm)</p>	473543	50
 <p>Standard bore extension set with three, 4-way, High-Flow open lumen stopcocks, and SPIN-LOCK connector. Not made with DEHP or natural rubber latex. Priming volume: 6 mL, Length: 47 in. (119 cm)</p>	473054	100
 <p>Standard bore extension set with 4-way, High-Flow open lumen stopcock, pinch clamp, CARESITE® Luer Access Device, and SPIN-LOCK® connector. Not made with DEHP or natural rubber latex. Priming volume: 6.1mL, Length: 40 in. (102 cm)</p>	490318	50
 <p>Standard bore extension set with two, 4-way, High-Flow open lumen stopcock, slide clamp, CARESITE® Luer Access Device, and SPIN-LOCK connector. Not made with DEHP or natural rubber latex. Priming volume: 5.3 mL, Length: 33 in. (84 cm)</p>	490418	50

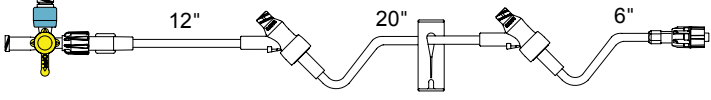
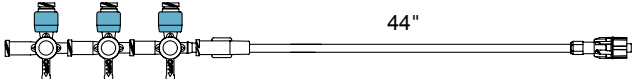
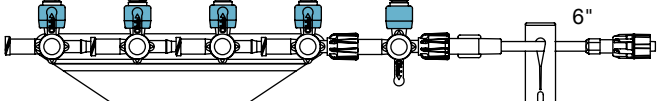
Description	REF Number	Unit Per cs
<p>Needleless Stopcocks</p>  <p>Standard bore extension set with 4-way, High-Flow ULTRAPORT™ stopcock with luer activated needleless port, and SPIN-LOCK® connector. Not made with DEHP or natural rubber latex. Priming volume: 1.5 mL, Length: 10 in. (25 cm)</p>	456507	100
 <p>Standard bore extension set with 4-way, High-Flow ULTRAPORT™ stopcock with luer activated needleless port, slide clamp, and SPIN-LOCK® connector. Not made with DEHP or natural rubber latex. Priming volume: 4.6 mL, Length: 29 in. (74 cm)</p>	456503	50
 <p>Standard bore extension set with 4-way, High-Flow ULTRAPORT™ stopcock with luer activated needleless port, slide clamp, and SPIN-LOCK® connector. Not made with DEHP or natural rubber latex. Priming volume: 6.9 mL, Length: 43 in. (109 cm)</p>	456508	50
 <p>Standard bore extension set with 4-way, High-Flow ULTRAPORT Zer0™ stopcock with luer activated needleless port, CARESITE® Luer Access Device, slide clamp, and SPIN-LOCK® connector. Not made with DEHP or natural rubber latex. Priming volume: 6.7 mL, Length: 42 in. (107 cm)</p>	457505	100
 <p>Standard bore extension set with 4-way, High-Flow ULTRAPORT™ stopcock with luer activated needleless port, CARESITE® needleless connector, slide clamp, and SPIN-LOCK® connector. Not made with DEHP or natural rubber latex. Priming volume: 6.3 mL Length: 42 in. (107 cm)</p>	354222	100
 <p>Standard bore extension set with 4-way, High-Flow ULTRAPORT Zer0™ stopcock with luer activated needleless port, two CARESITE® Luer Access Devices, slide clamp, and SPIN-LOCK® connector. Not made with DEHP or natural rubber latex. Priming volume: 6.7 mL Length: 42 in. (107 cm)</p>	490460	50
 <p>Standard bore extension set with three 4-way, High-Flow ULTRAPORT™ stopcocks with luer activated needleless ports, and SPIN-LOCK® connector. Not made with DEHP or natural rubber latex. Priming volume: 8 mL Length: 50 in. (127 cm)</p>	490139	50
 <p>Standard bore extension set with five 4-way, High-Flow ULTRAPORT™ stopcocks with luer activated needleless ports, slide clamp, and SPIN-LOCK® connector. Not made with DEHP or natural rubber latex. Priming volume: 2.4 mL Length: 15 in. (38 cm)</p>	490295	24

■ ULTRAPORT Zer0™ Stopcock
 ■ Needleless Valve (ULTRAPORT / ULTRAPORT Zer0™)

ANESTHESIA EXTENSION SETS

Description	REF Number	Unit Per cs
-------------	------------	-------------

Extension Sets with SAFEPORT™

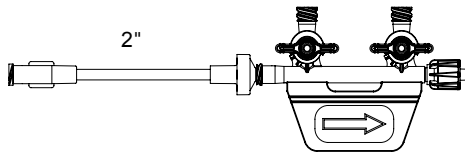

Standard bore extension set with two port SAFEPORT open lumen manifold, backcheck valve, and SPIN-LOCK® connector. Not made with DEHP or natural rubber latex. Priming volume: 1.4 mL Length: 7 in. (18 cm)

456520

50

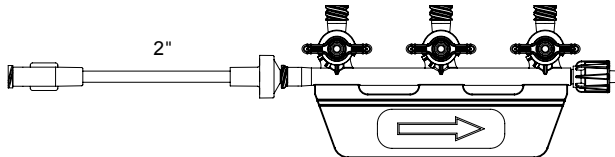

Triple port SAFEPORT with in-line backcheck valve and SPIN-LOCK connector. Not made with DEHP or natural rubber latex. Priming volume: 1.9 mL Approximate length: 8 in. (20.3 cm)

456522

50

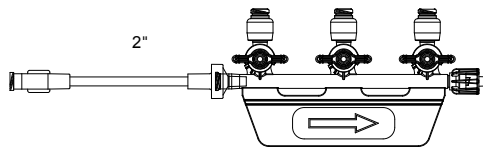

Standard bore extension set with three port SAFEPORT™ manifold with luer activated needleless ports, backcheck valve, and SPIN-LOCK® connector. Not made with DEHP or natural rubber latex. Priming volume: 1.9 mL Length: 8 in. (20.3 cm)

456521

50

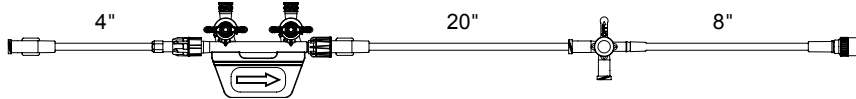

Standard bore extension set with two port SAFEPORT™ open lumen manifold, 4-way, High-Flow open lumen stopcock, and SPIN-LOCK® connector. Not made with DEHP or natural rubber latex. Priming volume: 6.3 mL Length: 39 in. (99 cm)

472036

50

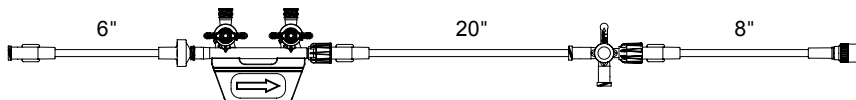

Standard bore extension set with two port SAFEPORT™ open lumen manifold, backcheck valve, 4-way, High-Flow open lumen stopcock, and SPIN-LOCK® connector. Not made with DEHP or natural rubber latex. Priming volume: 7 mL Length: 41 in. (104 cm)

472038

50



Standard bore extension set with 4-way, High-Flow ULTRAPORT™ stopcock with luer activated needleless port, two port SAFEPORT™ manifold with luer activated needleless ports, and SPIN-LOCK® connector. Not made with DEHP or natural rubber latex. Priming volume: 8 mL Length: 56 in. (142 cm)

456524

50

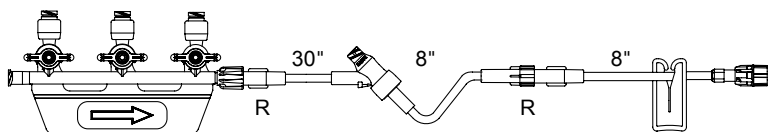

Standard bore extension set with three port SAFEPORT™ manifold with luer activated needleless ports, CARESITE® Luer Access Device, slide clamp, and SPIN-LOCK® connector. Not made with DEHP or natural rubber latex. Priming volume: 9.2 mL Length: 54 in. (137 cm)

490316

50

 ULTRAPORT Zer0™ Stopcock  Needleless Valve (ULTRAPORT / ULTRAPORT Zer0™)

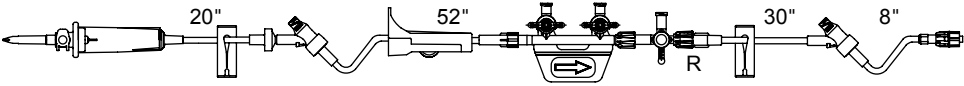
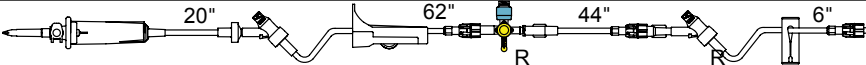
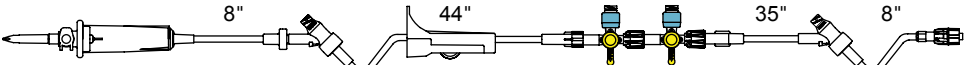
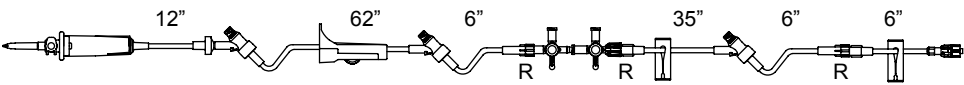
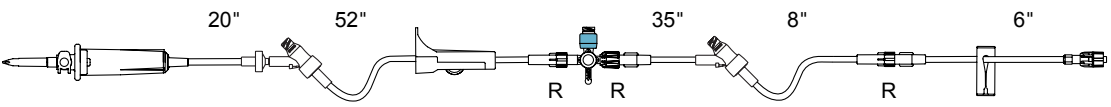
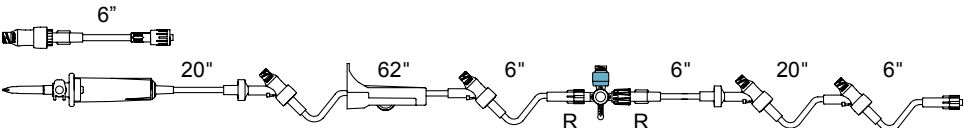
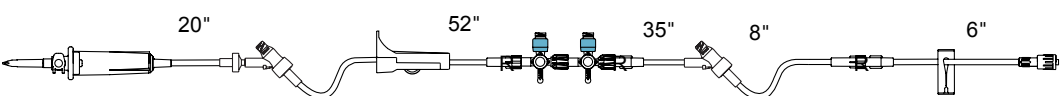
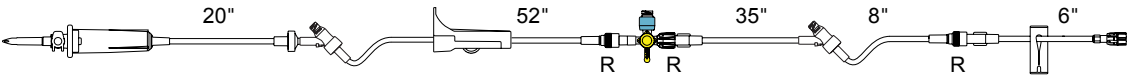
Description	REF Number	Unit Per cs
60 Drop Anesthesia IV Administration Sets		
 <p>(60 drop/mL) Universal spike set with backcheck valve, roller clamp, two slide clamps, two CARESITE Luer Access Devices, 4-way, High-Flow open lumen stopcock, two port SAFEPORT open lumen manifold, and SPIN-LOCK connector. Not made with DEHP or natural rubber latex. Priming volume: 21 mL Length: 122 in. (310 cm)</p>	352394	50
 <p>(60 drop/mL) Universal spike set with backcheck valve, roller clamp, two CARESITE® Luer Access Devices, 4-way, High-Flow ULTRAPORT Zer0™ stopcock with luer activated needleless port, slide clamp, and SPIN-LOCK® connector. Priming volume: 26 mL Length: 141 in. (358 cm)</p>	490349	24
 <p>(60 drop/mL) Universal spike set with backcheck valve, roller clamp, two CARESITE Luer Access Devices, two 4-way, High-Flow ULTRAPORT Zer0™ stopcock with luer activated needleless ports, and SPIN-LOCK connector. Priming volume: 20 mL Length: 106 in. (269 cm)</p>	490392	24
15 Drop Anesthesia IV Administration Sets with Stopcocks		
 <p>(15 drop/mL) Universal spike set with backcheck valve, roller clamp, two slide clamps, three CARESITE Luer Access Devices, two 4-way, High-Flow open lumen stopcocks, and SPIN-LOCK connector. Not made with DEHP or natural rubber latex. Priming volume: 25 mL Length: 139 in. (353 cm)</p>	490535	24
 <p>(15 drop/mL) Universal spike set with backcheck valve, roller clamp, two CARESITE Luer Access Devices, 4-way, High-Flow ULTRAPORT stopcock with luer activated needleless ports, slide clamp, and SPIN-LOCK connector. Not made with DEHP or natural rubber latex. Priming volume: 23 mL Length: 131 in. (333 cm)</p>	354209	50
 <p>(15 drop/mL) Universal spike set with two backcheck valves, roller clamp, four CARESITE Luer Access Devices, 4-way, High-Flow ULTRAPORT stopcock with luer activated needleless port, SPIN-LOCK connector, AND standard bore extension set with CARESITE Luer Access Device, slide clamp and SPIN-LOCK connector. Not made with DEHP or natural rubber latex. Priming volume: 24 mL Length: 132 in. (335 cm)</p>	490067	50
 <p>(15 drop/mL) Universal spike set with backcheck valve, roller clamp, slide clamp, two CARESITE® Luer Access Devices, two 4-way, High-Flow ULTRAPORT™ stopcocks with luer activated needleless ports, and SPIN-LOCK® connector. Not made with DEHP or natural rubber latex. Priming volume: 24 mL Length: 130 in. (330 cm)</p>	354210	50
 <p>(15 drop/mL) Universal spike set with backcheck valve, roller clamp, two CARESITE Luer Access Devices, 4-way, High-Flow ULTRAPORT Zer0™ stopcock with luer activated needleless ports, slide clamp, and SPIN-LOCK connector. Not made with DEHP or natural rubber latex. Priming volume: 23 mL Length: 131 in. (333 cm)</p>	457506	50

ANESTHESIA IV ADMINISTRATION SETS

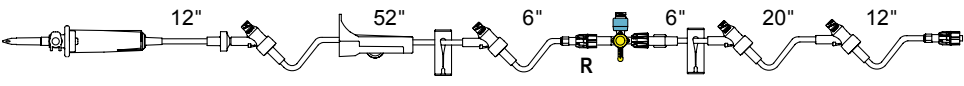
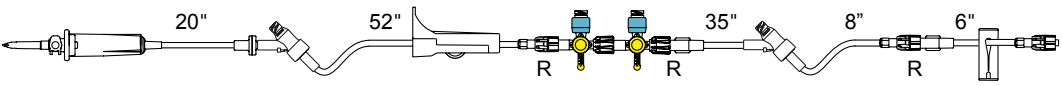
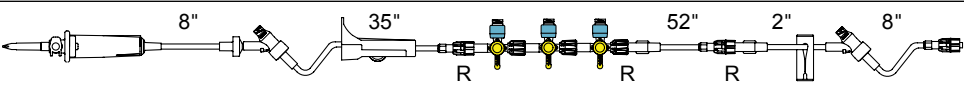
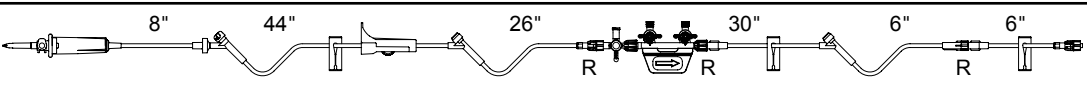
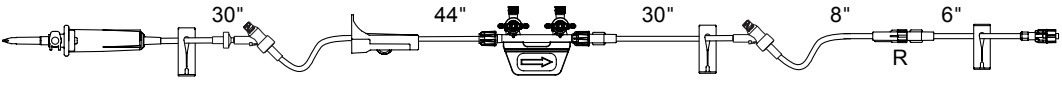
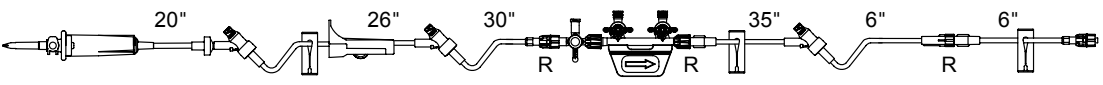
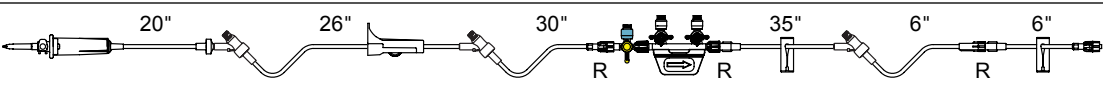

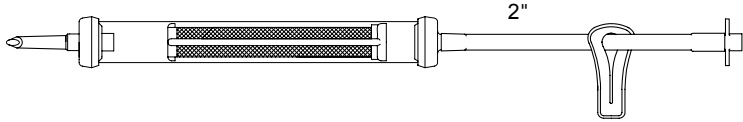
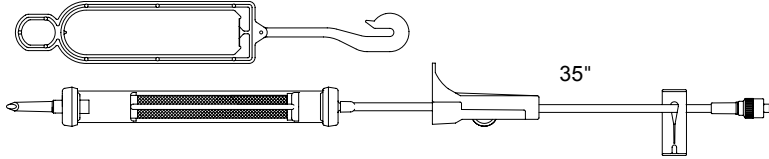
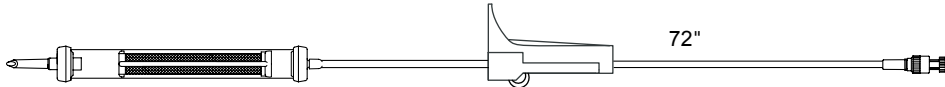
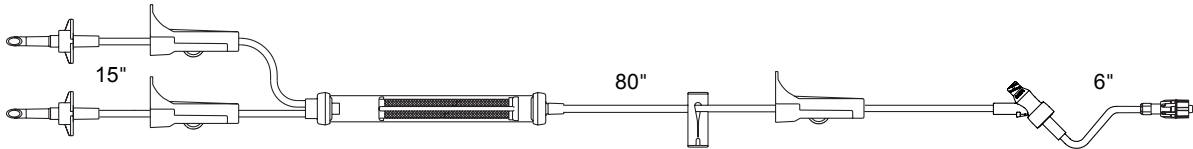
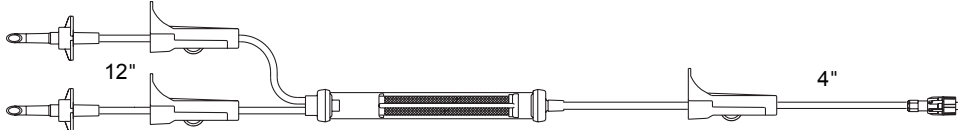
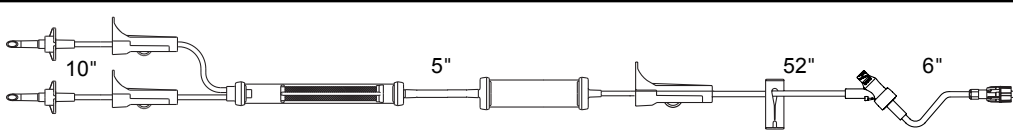
Description	REF Number	Unit Per cs
15 Drop Anesthesia IV Administration Sets with Stopcocks (continued)		
 <p>(15 drop/mL) Universal spike set with backcheck valve, roller clamp, four CARESITE Luer Access Devices, 4-way, High-Flow ULTRAPORT Zer0™ stopcock with luer activated needleless port, two slide clamps, and SPIN-LOCK connector. Not made with DEHP or natural rubber latex. Priming volume: 23 mL Length: 120 in. (304 cm)</p>	490427	24
 <p>(15 drop/mL) Universal spike set with backcheck valve, roller clamp, two CARESITE Luer Access Devices, two 4-way, High-Flow ULTRAPORT Zer0™ stopcocks with luer activated needleless ports, slide clamp, and SPIN-LOCK connector. Not made with DEHP or natural rubber latex. Priming volume: 23 mL Length: 130 in. (330 cm)</p>	457504	50
 <p>(15 drop/mL) Universal spike set with backcheck valve, roller clamp, two CARESITE Luer Access Devices, three 4-way, High-Flow ULTRAPORT Zer0™ stopcocks with luer activated needleless ports, slide clamp, and SPIN-LOCK connector. Not made with DEHP or natural rubber latex. Priming volume: 22 mL Length: 117 in. (297 cm)</p>	490468	24
15 Drop Anesthesia IV Administration Sets with SAFEPORT™ Manifolds		
 <p>(15 drop/mL) Universal spike set with backcheck valve, roller clamp, three SAFELINE® needleless connectors, three slide clamps, 4-way, High-Flow open lumen stopcock, two port SAFEPORT open lumen manifold, and SPIN-LOCK® connector. Not made with DEHP or natural rubber latex. Priming volume: 24 mL Length: 134 in. (340 cm)</p>	NF1270A	50
 <p>(15 drop/mL) Universal spike set with backcheck valve, roller clamp, two CARESITE® Luer Access Devices, two port SAFEPORT open lumen manifold, three slide clamps, removable 6 in. Extension set, and SPIN-LOCK connector. Not made with DEHP or natural rubber latex. Priming volume: 23 mL Length: 131 in. (333 cm)</p>	354208	50
 <p>(15 drop/mL) Universal spike set with backcheck valve, roller clamp, three CARESITE Luer Access Devices, three slide clamps, 4-way, High-Flow open lumen stopcock, two port SAFEPORT open lumen manifold, removable 6 in. Extension tubing and SPIN-LOCK connector. Not made with DEHP or natural rubber latex. Priming volume: 24 mL Length: 137 in. (348 cm)</p>	354211	50
 <p>(15 drop/mL) Universal spike set with backcheck valve, roller clamp, three CARESITE Luer Access Devices, two slide clamps, High-Flow ULTRAPORT Zer0™ stopcock with luer activated needleless ports, two port SAFEPORT manifold with luer activated needleless ports, removable 6 in. extension tubing, and SPIN-LOCK connector. Not made with DEHP or natural rubber latex. Priming volume: 24 mL Length: 136 in. (345 cm)</p>	457515	50

Description	REF Number	Unit Per cs
<p>Blood Administration Sets</p>  <p>(10 drop/mL) Drip chamber with 170 micron blood filter, slide clamp and spike adapter. Not made with natural rubber latex. Contains DEHP. Priming volume: 19 mL Length: 9 in. (23 cm)</p>	V2950	50
 <p>(10 drop/mL) Drip chamber with 170 micron blood filter, roller clamp, slide clamp, SPIN-LOCK® connector, and bag hanger. Not made with natural rubber latex. Contains DEHP. Priming volume: 23 mL Length: 40 in. (101 cm)</p>	470032	50
 <p>(10 drop/mL) Drip chamber with 170 micron blood filter, roller clamp, and SPIN-LOCK connector. Not made with DEHP. Filter Contains DEHP. Priming volume: 31 mL Length: 76 in. (193 cm)</p>	V2400	50
 <p>(10 drop/mL) Y-type blood set with two non-vented spikes, 170 micron filter, slide clamp, three roller clamps, CARESITE® Luer Access Device, and SPIN-LOCK connector. Not made with natural rubber latex. Contains DEHP. Priming volume: 31 mL Length: 110 in. (279 cm)</p>	354217	50
 <p>(10 drop/mL) Y-type blood set with two non-vented spikes, 170 micron filter, three roller clamps, and SPIN-LOCK connector. Not made with natural rubber latex. Contains DEHP. Priming volume: 33 mL Length: 83 in. (211 cm)</p>	V2500	50
 <p>(10 drop/mL) Y-type blood set with two non-vented spikes, 170 micron filter, hand pump, slide clamp, three roller clamps, CARESITE® Luer Access Device, and SPIN-LOCK connector. Not made with natural rubber latex. Contains DEHP. Priming volume: 75 mL Length: 89 in. (226 cm)</p>	354218	50

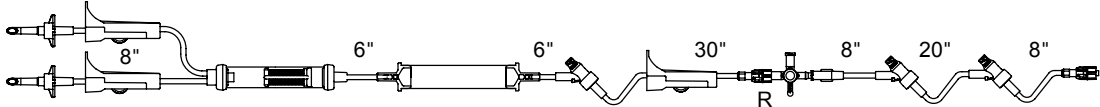
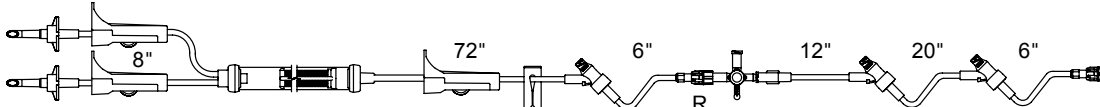
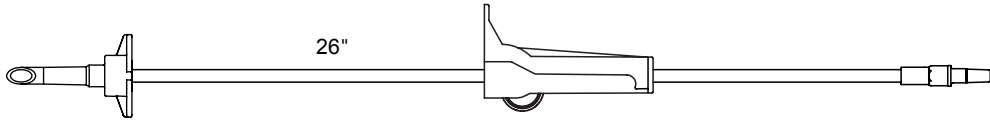

BLOOD ADMINISTRATION SETS

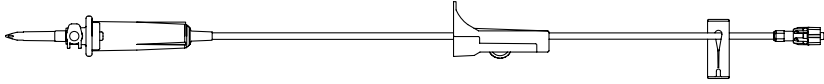
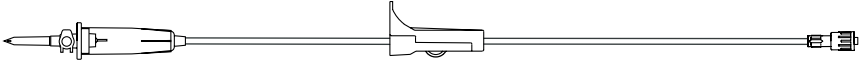
Description	REF Number	Unit Per cs
Blood Administration Sets (continued)		
 <p data-bbox="134 380 1211 464">(10 drop/mL) Y-type blood set with two non-vented spikes, 170 micron filter, hand pump, three roller clamps, three CARESITE luer access devices, 4-way High-Flow open lumen stopcock and SPIN-LOCK connector. Not made with natural rubber latex. Contains DEHP. Priming volume: 74 mL Length: 105 in. (267 cm)</p>	490425	24
 <p data-bbox="134 606 1211 686">(10 drop/mL) Y-type blood set with two non-vented spikes, 170 micron filter, slide clamp, three roller clamps, three CARESITE luer access devices, 4-way High-Flow open lumen stopcock and SPIN-LOCK connector. Not made with natural rubber latex. Contains DEHP. Priming volume: 38 mL Length: 135 in. (343 cm)</p>	490293	24
Plasma Transfer Administration Set		
 <p data-bbox="134 909 1240 961">Plasma Transfer Set, with non-vented spike, roller clamp, and male luer slip connector. Not made with DEHP or natural rubber latex. Priming volume: 4.7 mL Length: 29 in. (74 cm)</p>	V2203	50

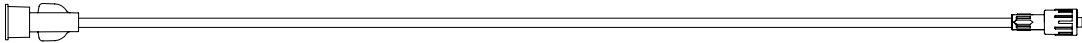
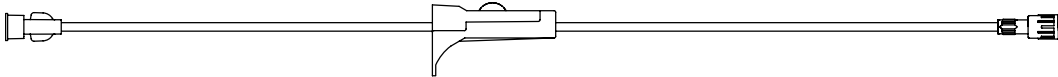
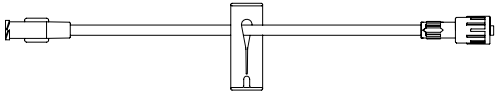
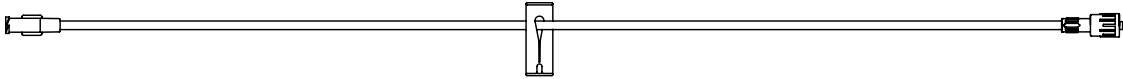
BASIC IV ADMINISTRATION SETS AND EXTENSION SETS

Description	Product Code	REF Number	Unit Per cs
Basic IV Administration Sets			
	V1501	352601	50
(15 drops/mL) Universal spike, roller clamp, slide clamp, and SPIN-LOCK® connector. Not made with DEHP or natural rubber latex. Priming Volume: 13 mL, Length: 85 in. (215.9 cm). Labeled "Contents Sterile".			
	V1425-15	V1425-15	50
(60 drops/mL) Universal spike, roller clamp, SPIN-LOCK connector. Not made with DEHP or natural rubber latex. Priming Volume: 13 mL, Length: 67 in. (170.2 cm)			
	V1921	V1921	50
Secondary Administration Set (15 drops/mL) Universal spike, roller clamp, SPIN-LOCK connector, with 10.5" plastic bag hanger. Not made with DEHP or natural rubber latex. Priming Volume: 8.8 mL, Length: 40 in. (101.6 cm).			
Standard Bore Extension Sets			
	V5406	V5406	50
Female luer connector, distal SPIN-LOCK connector. Not made with DEHP or natural rubber latex. Priming volume: 3 mL. Length 21 in. (52.5 cm)			
	V5484	V5484	50
Female luer connector, large bore tubing, roller clamp, distal SPIN-LOCK connector. Not made with DEHP or natural rubber latex. Priming volume: 4.3 mL. Length: 31 in. (78.5 cm)			
	ET06L	471975	100
Female luer connector, distal SPIN-LOCK connector. Not made with DEHP or natural rubber latex. Priming volume: 1 mL. Length: 7 in. (18 cm)			
	ET30LC	473012	100
Female luer connector, slide clamp, distal SPIN-LOCK connector. Not made with DEHP or natural rubber latex. Priming volume: 4.3 mL. Length: 30 in. (76 cm)			

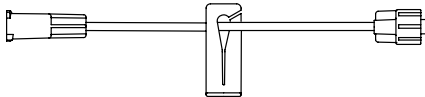

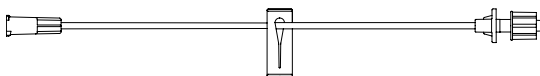
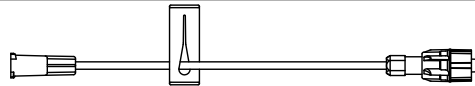
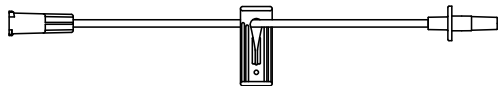
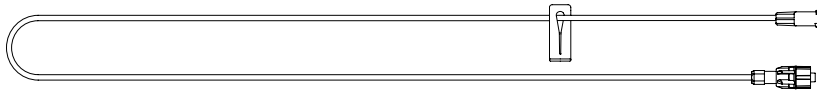
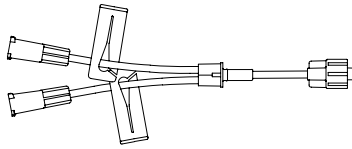
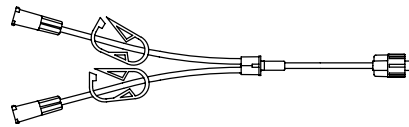
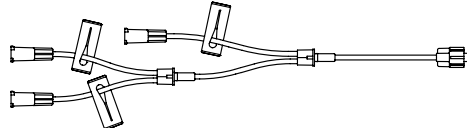
EXTENSION SETS

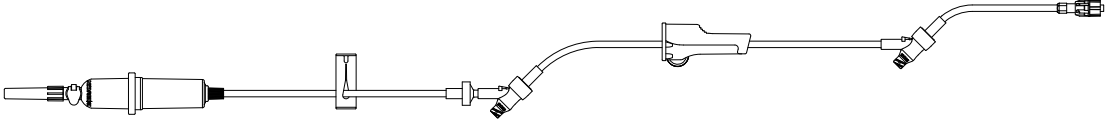
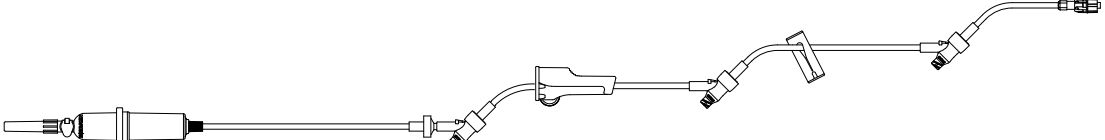
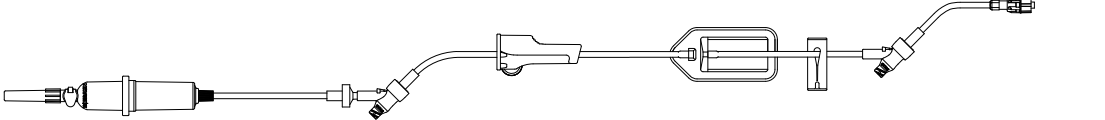
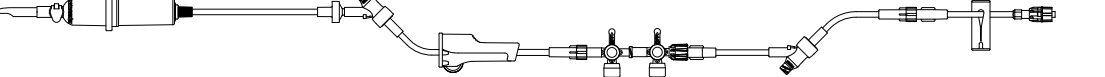
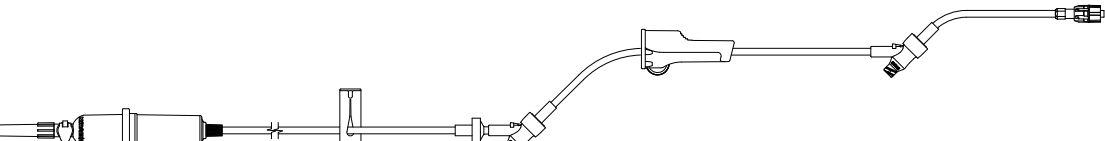
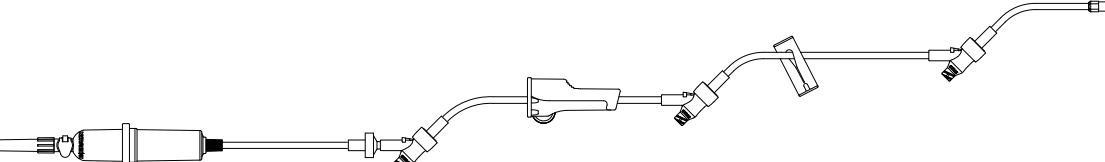

Description	Product Code	REF Number	Unit Per cs
Small Bore Extension Sets			
 <p>Female luer connector, slide clamp, distal male luer lock connector. Not made with DEHP or natural rubber latex. Priming volume: 0.2 mL. Length: 6 in. (15.2 cm)</p>	ET06S	471960	100
 <p>For use with power injectors - maximum 300 psi and maximum flow rate 10 mL/sec</p> <p>Small bore extension set. Female luer connector, fixed slide clamp and SPIN-LOCK® connector. Not made with DEHP or natural rubber latex. Priming volume: 0.3 mL. Length: 7 in. (18 cm)</p>		470064	50
 <p>Female luer connector, non-removable slide clamp, distal SPIN-LOCK® connector. Not made with DEHP or natural rubber latex. Priming volume: 0.44 mL. Length 13 in. (31.0 cm)</p>	ET12SB	473105	100
 <p>Small bore extension set. Female luer connector, fixed slide clamp and SPIN-LOCK connector. Not made with DEHP or natural rubber latex. Priming volume: 0.5 mL. Length: 17 in. (43 cm)</p>		470645	100
 <p>Female luer connector, slide clamp, distal male luer slip connector. Not made with DEHP or natural rubber latex. Priming volume: 0.2 mL. Length: 6 in. (15.2cm)</p>	ET06LS	471991	100
 <p>Female luer connector, slide clamp, distal male SPIN-LOCK connector. Not made with DEHP or natural rubber latex. Priming volume: 2 mL. Length: 61 in. (155 cm)</p>	ET112	471973	100
 <p>Y-type with 2 female luer connectors, 2 slide clamps, distal male luer lock connector. Not made with DEHP or natural rubber latex. Priming volume: 0.46 mL. Length: 6 in. (15 cm)</p>	ET06MDA	471957	100
 <p>Y-type with 2 female luer lock connectors, 2 on/off clamps and distal male luer lock connector. Not made with DEHP or natural rubber latex. Priming volume: 0.5 mL. Length: 8 in. (20 cm)</p>	ET103	471959	100
 <p>Triple-leg set with 3 female luer connectors, 3 non-removable slide clamps, distal male luer lock connector. Not made with DEHP or natural rubber latex. Priming volume: 0.5 mL. Length: 9 in. (23 cm)</p>	ET110	473041	100

CARESAFE™ IV ADMINISTRATION SETS AND EXTENSION SETS

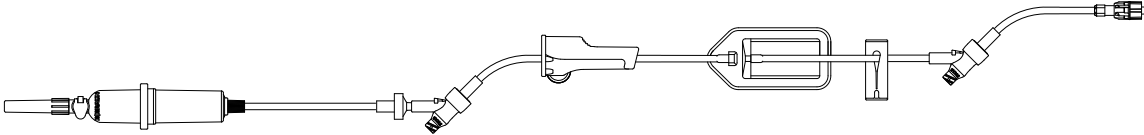
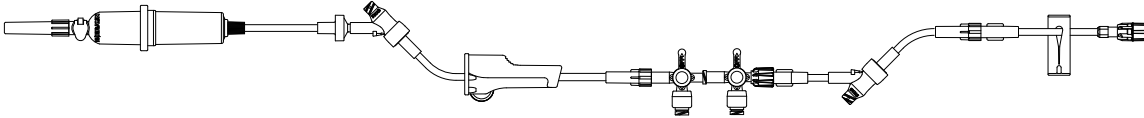
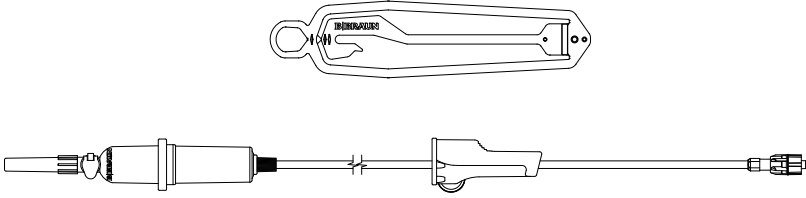
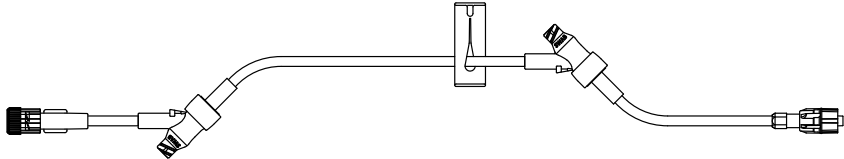
Description	Product Code	REF Number	Unit Per cs
CARESAFE™ IV Administration Sets with AirStop			
			
<p>(20 drops/mL) Drip Chamber with AirStop, slide clamp, backcheck valve, CARESITE® valve injection sites 87 in. and 12 in. above distal end, roller clamp, SPIN-LOCK® connector. Components are not made with PVC, DEHP, or natural rubber latex. Priming volume: 24 mL, Length: 104 in. (264 cm)</p>	354302	50	
			
<p>(20 drops/mL) Drip Chamber with AirStop, backcheck valve, CARESITE® valve injection sites 85 in., 41 in. and 6 in. above distal end, roller clamp, slide clamp, SPIN-LOCK® connector. Components are not made with PVC, DEHP, or natural rubber latex. Priming volume: 26 mL, Length: 114 in. (290 cm)</p>	354304	50	
			
<p>(20 drops/mL) Drip Chamber with AirStop, backcheck valve, CARESITE® injection sites 87 in. and 6 in. above distal end, roller clamp, 0.2 micron air eliminating filter, slide clamp, SPIN-LOCK® connector. Components are not made with PVC, DEHP, or natural rubber latex. Priming volume: 28 mL, Length: 110 in. (279 cm)</p>	354306	50	
			
<p>(20 drops/mL) Drip Chamber with AirStop, backcheck valve, two CARESITE® injection sites, roller clamp, two removable high-flow, four-way stopcocks with luer-activated ULTRAPORT® port, female luer lock port, and SPIN-LOCK® connector, removable 6 in. (15.2 cm) extension tubing with luer lock connection, slide clamp and SPIN-LOCK® connector. Components are not made with PVC, DEHP, or natural rubber latex. Priming volume: 30 mL. Length: 134 in. (340 cm)</p>	354308	50	
CARESAFE™ IV Administration Sets			
			
<p>(20 drops/mL) Drip Chamber with 15µm Filter, slide clamp, backcheck valve, CARESITE® valve injection sites 87 in. and 12 in. above distal end, roller clamp, SPIN-LOCK® connector. Components are not made with PVC, DEHP, or natural rubber latex. Priming volume: 24 mL, Length: 104 in. (264 cm)</p>	354303	50	
			
<p>(20 drops/mL) Drip Chamber with 15µm Filter, backcheck valve, two CARESITE® injection sites, roller clamp, two removable high-flow, four-way stopcocks with luer-activated ULTRAPORT® port, female luer lock port, and SPIN-LOCK® connector, removable 6 in. (15.2 cm) extension tubing with luer lock connection, slide clamp and SPIN-LOCK® connector. Components are not made with PVC, DEHP, or natural rubber latex. Priming volume: 30 mL. Length: 134 in. (340 cm)</p>	354305	50	

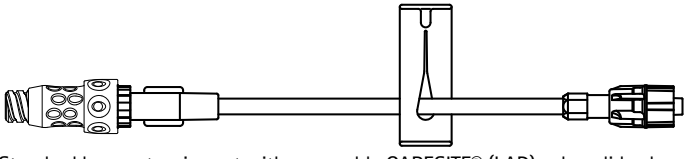
CARESAFE™ IV ADMINISTRATION SETS AND EXTENSION SETS

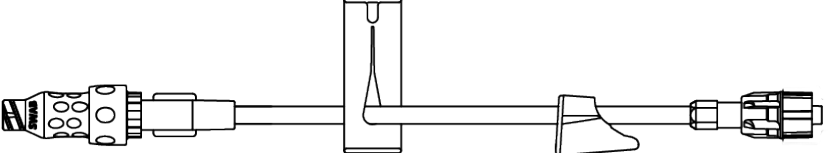
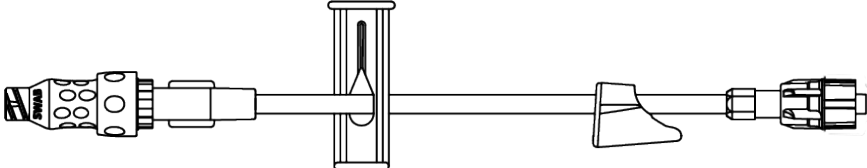

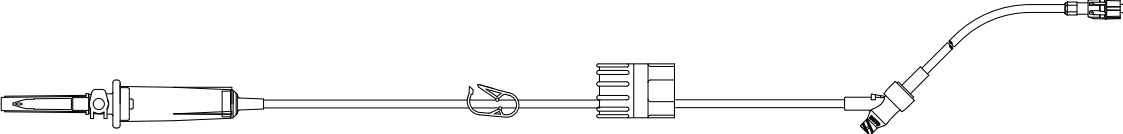
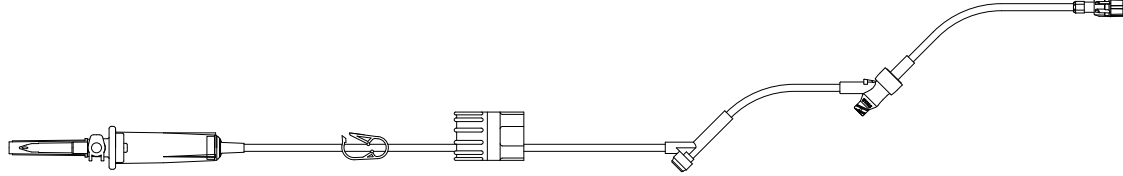
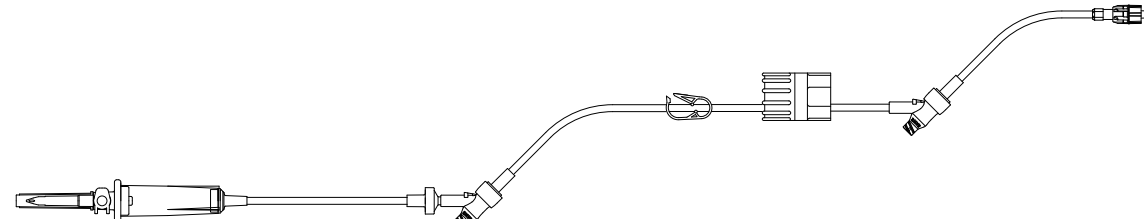
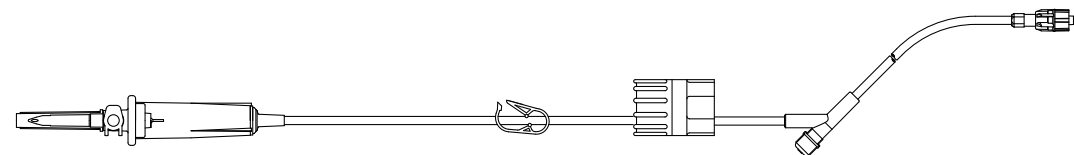
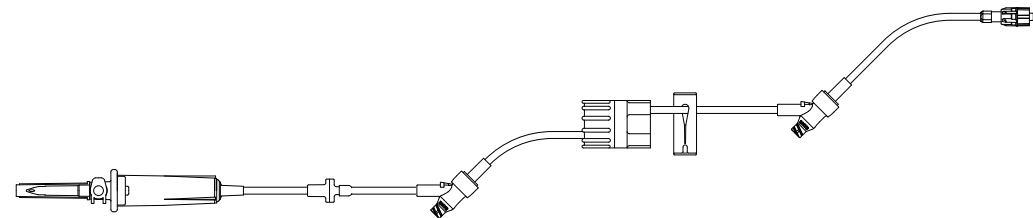

Description	Product Code	REF Number	Unit Per cs
CARESAFE™ IV Administration Sets (continued)			
 <p data-bbox="133 401 1073 533">(20 drops/mL) Drip Chamber with 15µm Filter, backcheck valve, two CARESITE® injection sites, roller clamp, two removable high- flow, four-way stopcocks with luer-activated ULTRAPORT® port, female luer lock port, and SPIN-LOCK® connector, removable 6 in. (15.2 cm) extension tubing with luer lock connection, slide clamp and SPIN-LOCK® connector. Components are not made with PVC, DEHP, or natural rubber latex. Priming volume: 30 mL. Length: 134 in. (340 cm)</p>	354307	50	
 <p data-bbox="133 720 1073 856">(20 drops/mL) Drip Chamber with 15µm Filter, backcheck valve, two CARESITE® injection sites, roller clamp, two removable high- flow, four-way stopcocks with luer-activated ULTRAPORT® port, female luer lock port, and SPIN-LOCK® connector, removable 6 in. (15.2 cm) extension tubing with luer lock connection, slide clamp and SPIN-LOCK® connector. Components are not made with PVC, DEHP, or natural rubber latex. Priming volume: 30 mL. Length: 134 in. (340 cm)</p>	354310	50	
 <p data-bbox="133 1083 1073 1167">(20 drops/mL) Drip Chamber with 15µm Filter, roller clamp, SPIN-LOCK® connector, with plastic bag hanger. Components are not made with PVC, DEHP, or natural rubber latex. Priming Volume: 12 mL, Length: 41 in. (104 cm).</p>	V1931	50	
CARESAFE™ Extension Sets			
 <p data-bbox="133 1430 1097 1507">Standard bore extension set with two CARESITE® valve injection sites 28 in. and 6 in. above distal end, non-removable slide clamp, SPIN-LOCK® connector. Components are not made with PVC, DEHP, or natural rubber latex. Priming volume: 6.3 mL, Length: 35 in. (89 cm)</p>	354320	50	
 <p data-bbox="133 1692 1109 1749">Standard bore extension set with bonded CARESITE® (LAD) valve, slide clamp, SPIN-LOCK® connector. Components are not made with PVC, DEHP, or natural rubber latex. Priming volume: 1.3 mL, Length: 8 in. (20 cm)</p>	471858	50	
 <p data-bbox="133 1923 1109 1980">Standard bore extension set with removable CARESITE® (LAD) valve, slide clamp, SPIN-LOCK® connector. Components are not made with PVC, DEHP, or natural rubber latex. Priming volume: 1.3 mL, Length: 8 in. (20 cm)</p>	471859	50	

Description	Product Code	REF Number	Unit Per cs
<p>STEADYCare™ Extension Sets</p>  <p>Small bore tubing, Caresite® luer access device (LAD), Spin-Lock® connector, and removable slide clamp, 8 in. Not made with DEHP or natural rubber latex.</p>	470185	100	
 <p>Standard bore tubing, Caresite LAD, and Spin-Lock connector, 7 in. Not made with DEHP or natural rubber latex.</p>	470186	100	
 <p>Standard bore tubing, Caresite LAD, and Spin-Lock connector, 8 in. Not made with DEHP or natural rubber latex.</p>	470188	100	
 <p>Small bore tubing, female luer lock connector, Spin-Lock connector, 7 in. Not made with DEHP or natural rubber latex.</p>	470193	50	

RATE FLOW® REGULATOR II ADMINISTRATION SETS

Description	REF Number	Unit Per cs
Rate Flow® Regulator II Administration Sets		
	375256	50
Rate Flow Extension Set with CARESITE® Luer Access Device (LAD), Spin-Lock Connector. Components are not made with natural rubber latex. Priming Volume: 2.8 mL. Length: 17 in.		
	375257	50
Rate Flow IV Set with 15 drop/mL Drip Chamber with 15 Micron Filter, CARESITE LAD, Spin-Lock Connector. Components are not made with natural rubber latex. Priming Volume: 15 mL. Length: 82 in.		
	375261	50
Rate Flow IV Set with 15 drop/mL Drip Chamber with 15 Micron Filter, Split Septum Injection Site, CARESITE LAD, and Spin-Lock Connector. Components are not made with natural rubber latex. Priming Volume: 17 mL. Length: 93 in.		
	375258	50
Rate Flow IV Set with 15 drop/mL Drip Chamber with 15 Micron Filter, LP Check Valve, 2 CARESITE LAD's, Spin-Lock Connector. Components are not made with natural rubber latex. Priming Volume: 17 mL. Length: 92 in.		
	375252	50
Rate Flow IV Set with 60 drop/mL Drip Chamber with 15 Micron Filter, Injection Site, Spin-Lock Connector. Components are not made with natural rubber latex. Priming Volume: 15 mL. Length: 82 in.		
	375260	50
Rate Flow IV Set with 10 drop/mL Drip Chamber, Backcheck Valve, 2 CARESITE LAD's, Spin-Lock Connector. Components are not made with natural rubber latex. Priming Volume: 21 mL. Length: 108 in.		

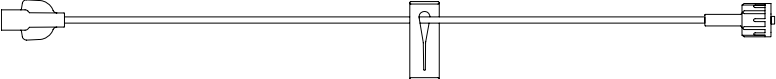
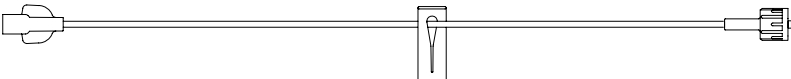

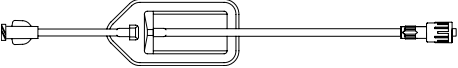
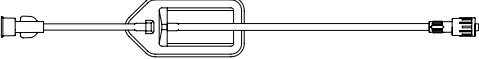
SYRINGE PUMP PE-LINED FLUID PATH MICROBORE AND FILTERED EXTENSION SETS

Description	Product Code	REF Number	Unit Per cs
Syringe Pump PE-Lined Fluid Path Microbore Extension Sets			
 <p>Female luer and distal male luer lock. Microbore extension set, 0.02 in. ID. tubing with fluid path that does not contain PVC. Does not contain DEHP or natural rubber latex. Priming volume: 0.3 mL, Length: 36 in. (91 cm)</p>	V6220	50	
 <p>Female luer and distal male luer lock. Microbore extension set, 0.03 in. ID. tubing with fluid path that does not contain PVC. Use with higher flow rates and viscous fluids. Does not contain DEHP or natural rubber latex. Priming volume: 0.6 mL, Length: 36 in. (91 cm)</p>	V6203	50	
 <p>Female luer and distal male luer lock. Microbore extension set, 0.02 in. ID. tubing with fluid path that does not contain PVC. Does not contain DEHP or natural rubber latex. Priming volume: 0.5 mL, Length: 60 in. (152 cm)</p>	V6222	50	
 <p>Female luer and distal male luer lock. Microbore extension set, 0.03 in. ID. with fluid path that does not contain PVC. Use with higher flow rates and viscous fluids. Does not contain DEHP or natural rubber latex. Priming volume: 0.8 mL, Length: 60 in. (152 cm)</p>	V6223	50	
 <p>Female luer and distal male luer lock. Microbore extension set, 0.2 micron filter, 0.03 in. ID. tubing with fluid path that does not contain PVC. Does not contain DEHP. Priming volume: 1.3 mL, Length: 60 in. (152 cm)</p>	V6215	50	
Syringe Pump Microbore Extension Sets with Proximal and Distal Male Luer Locks			
 <p>Proximal and distal male luer locks. Microbore extension set, 0.04 in. ID., slide clamp. Does not contain DEHP or natural rubber latex. Priming volume: 0.6 mL, Length: 31 in. (79 cm)</p>	V5450	50	
Filtered Extension Sets includes PES filter with an acrylic housing			
with 1.2 micron air-eliminating filter			
 <p>1.2 micron air-eliminating filter with luer lock connector. Filter is PES with an acrylic housing. Not made with DEHP or natural rubber latex. Priming Volume: 4.3 mL, Length: 10 in. (25 cm)</p>	FE1209F	473994	50
with 5.0 micron air-eliminating filter			
 <p>5.0 micron air-eliminating in-line filter with female luer connector, male SPIN-LOCK connector. Filter is PES with an acrylic housing. Not made with DEHP or natural rubber latex. Priming volume: 3.6 mL. Length: 10 in. (25.4 cm).</p>	FE5009F	474002	50

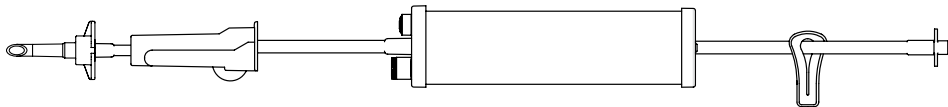
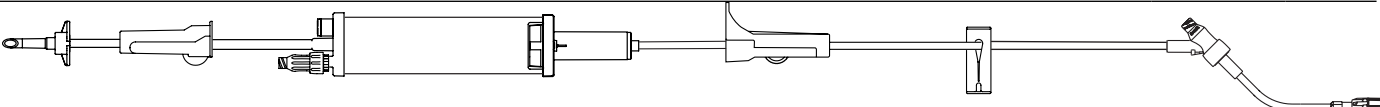
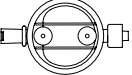
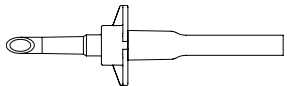
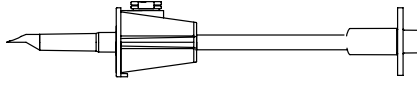
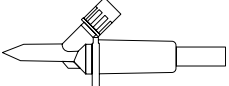
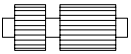
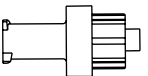
MEASURED VOLUME SOLUTION BURETTE SETS AND SPECIAL APPLICATION ACCESSORIES

Description	Product Code	REF Number	Unit Per cs
Measured Volume Solution Burette Sets			
 <p>Non-vented spike, roller clamp, 150 mL burette chamber without automatic shutoff with CARESITE valve, slide clamp, spike adapter. Contains DEHP. Not made with natural rubber latex. Priming volume: 3.0 mL Length: 20 in. (51.0 cm)</p>	470118	470118	20
 <p>Non-vented spike, roller clamp, 150 mL burette chamber, slide clamp, spike adapter. Not made with natural rubber latex. Contains DEHP. Not made with natural rubber latex. Priming Volume: 3 mL, Length: 20 in. (51.0 cm)</p>	V2905M	375112	20
 <p>(60 drops/mL) Non-vented spike, roller clamp, 150 mL burette chamber with CARESITE valve, roller clamp, slide clamp, CARESITE injection site 6 in. above distal end, SPIN-LOCK connector. Contains DEHP. Not made with natural rubber latex. Priming volume: 16.0 mL Length: 89 in. (226 cm)</p>	470116	470116	20
Special Application Accessories			
 <p>0.2 micron SUPOR Low Volume air-eliminating IV filter with female luer lock and SPIN-LOCK connectors. Not made with DEHP or natural rubber latex. Priming Volume: 0.8 mL.</p>	473036	473036	50
 <p>Spike Adapter. Contains DEHP. Not made with natural rubber latex.</p>	N2050	N2050	24
 <p>Vented Spike Adapter. Not made with DEHP or natural rubber latex.</p>	N2061	N2061	50
 <p>Vented Spike Adapter-permits connection of non-vented IV spike to IV bottle requiring a vent. Contains DEHP. Not made with natural rubber latex.</p>	SA2000	418105	20
 <p>Dual Male Adapter-male luer lock connector and distal SPIN-LOCK® connector. Connects two female luer connections. Not made with DEHP or natural rubber latex. Priming volume: 0.1 mL</p>	DMA1000	456080	100
 <p>Normally Closed Check Valve/Antisiphon Valve - requires syringe pressure to open, luer lock. Not made with DEHP or natural rubber latex. Priming volume: 0.12 mL</p>	BC1000	415062	100

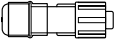
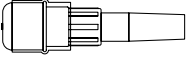
INJECTION CAPS AND REPLACEMENT CAPS

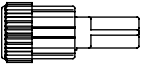
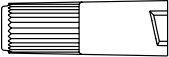
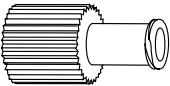
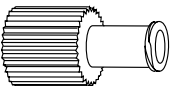
Description	Product Code	REF Number	Unit Per cs
Injection Caps			
 <p>Intermittent Injection Cap - opaque yellow body, proximal self-sealing injection port, distal male luer lock connector with recessed luer taper. Not made with DEHP or natural rubber latex. Priming volume: 0.16 mL. Length: 0.875 in. (2.2 cm)</p>	IN1000	654237	1000
 <p>Intermittent Injection Cap - proximal injection port, clear body, distal male luer lock connector. Not made with DEHP or natural rubber latex. Priming volume: 0.2 mL. Length: 1.125 in. (2.9 cm)</p>	IN2000	418020	100
 <p>Intermittent Injection Cap - proximal injection port, distal luer slip connector. Not made with DEHP or natural rubber latex. Priming volume: 0.2 mL. Length: 1.125 in. (2.9 cm)</p>	IN3000	418025	100
 <p>Intermittent Injection Cap - proximal injection port, distal male luer lock connector. Not made with DEHP or natural rubber latex. Priming volume: 0.1 mL. Length: 0.75 in. (1.9 cm)</p>	IN4000	418030	100
Replacement Caps			
 <p>Blue Replacement Cap - male luer lock. Not made with DEHP or natural rubber latex.</p>	B1000	418017	100
<p>Blue Replacement Cap - bulk pack of 1,000 in dispenser boxes of 100 each. Not made with DEHP or natural rubber latex.</p>	B1000B	418027	1000
<p>White Replacement Cap - male luer lock. Not made with DEHP or natural rubber latex.</p>	C1000	418015	100
 <p>Replacement Caps - blue male luer lock cap and white female luer lock cap. Not made with DEHP or natural rubber latex.</p>	BW1000	BW1000	100
 <p>White Replacement Cap - female luer lock. Not made with DEHP or natural rubber latex.</p>	W1000	474900	100
 <p>RED CAP™ luer cap - Dual function red cap with male and female end. Bulk pack of 1,000 in dispenser. Not made with DEHP or natural rubber latex.</p>	R2000B	R2000B	1000
 <p>Blue Cap luer cap - Dual function blue cap with male and female end. Bulk pack of 1,000 in dispenser boxes of 100 each. Not made with DEHP or natural rubber latex.</p>	B2000B	B2000B	1000

CARESITE® LUER ACCESS DEVICE (LAD) SYSTEM

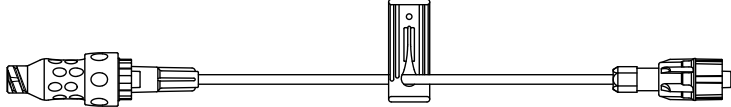
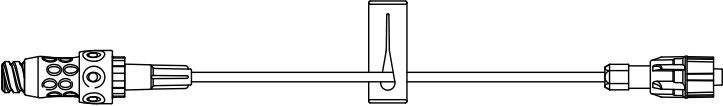
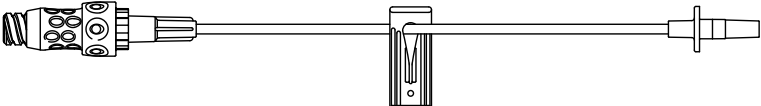
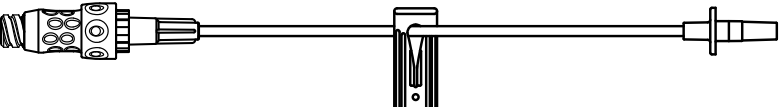
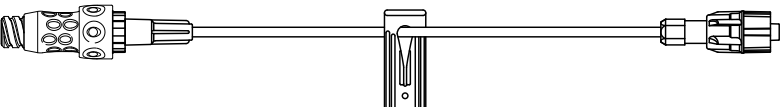
Description	REF Number	Unit Per cs
CARESITE (LAD)	415122	200
 CARESITE (LAD) valve for aspiration, injection or gravity flow of fluid upon insertion of a male luer fitting. Priming volume: 0.22 mL. Power injection rated to 400 psi and 15 mL/sec		
CARESITE Small Bore Extension Sets		
	470100	100
For use with power injectors - maximum 300 psi and maximum flow rate 10 mL/sec Small bore extension set with bonded CARESITE (LAD) valve, slide clamp, SPIN-LOCK® connector. Not made with DEHP or natural rubber latex. Priming volume: 0.5 mL, Length: 8 in. (20 cm) Power injection rated to 300 psi and 10 mL/sec.		
	470101	100
Small bore extension set with removable CARESITE (LAD) valve, slide clamp, SPIN-LOCK connector. Not made with DEHP or natural rubber latex. Priming volume: 0.5 mL, Length: 8 in. (20 cm)		
	470102	100
Small bore extension set with bonded CARESITE (LAD) valve, slide clamp, male luer slip connector. Not made with DEHP or natural rubber latex. Priming volume: 0.5 mL, Length: 8 in. (20 cm)		
	470103	100
Small bore extension set with removable CARESITE (LAD) valve, slide clamp, male luer slip connector. Not made with DEHP or natural rubber latex. Priming volume: 0.5 mL, Length: 8 in. (20 cm)		
	470104	100
Small bore extension set with bonded CARESITE (LAD) valve, slide clamp, SPIN-LOCK connector. Not made with DEHP or natural rubber latex. Priming volume: 0.7 mL, Length: 14 in. (36 cm)		

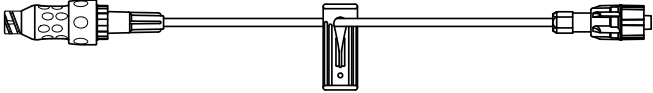
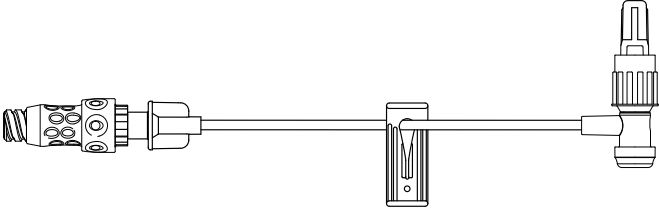
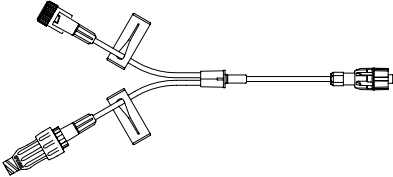
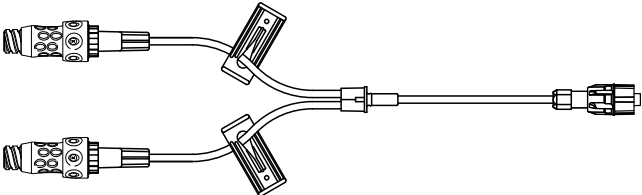
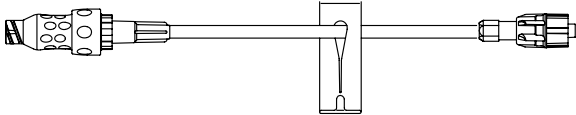
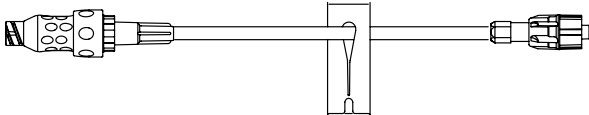
Description	REF Number	Unit Per cs
CARESITE Small bore Extension Sets (continued)		
	470105	100
<p>Small bore extension set with removable CARESITE (LAD) valve, slide clamp, SPIN-LOCK connector. Not made with DEHP or natural rubber latex. Priming volume: 0.7 mL, Length: 14 in. (36 cm)</p>		
	470128	50
<p>Small bore T-Port Extension Set with CARESITE (LAD), SafeLine® Injection Site on T-Port, slide clamp, and PE Fluid Path Tubing. Not made with DEHP or natural rubber latex. Priming volume: 0.27 mL, Length: 7 in. (18 cm)</p>		
	470107	50
<p>Small bore Y-extension set with one removable CARESITE (LAD) valve, two slide clamps, SPIN-LOCK connector. Not made with DEHP or natural rubber latex. Priming volume: 0.9 mL, Length: 7 in. (18 cm)</p>		
	354250	50
<p>Small bore high pressure rated Y-extension set with two bonded CARESITE (LAD) valves, two slide clamps, SPIN-LOCK® connector. Set rated to 300 psi and max flow rate 10 ml/sec. Not made with DEHP or natural rubber latex. Priming volume: 1.0 mL, Length: 8 in. (20 cm)</p>		
CARESITE Standard Bore Extension Sets		
	470108	100
<p>Standard bore extension set with bonded CARESITE (LAD) valve, slide clamp, SPIN-LOCK connector. Not made with DEHP or natural rubber latex. Priming volume: 0.9 mL, Length: 6 in. (15 cm)</p>		
	470109	100
<p>Standard bore extension set with removable CARESITE (LAD) valve, slide clamp, SPIN-LOCK connector. Not made with DEHP or natural rubber latex. Priming volume: 0.9 mL, Length: 6 in. (15 cm)</p>		

CARESITE® LUER ACCESS DEVICE (LAD) SYSTEM

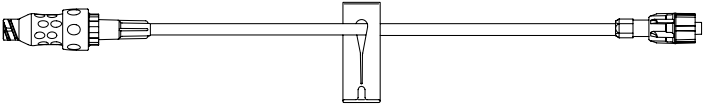
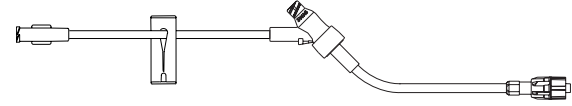
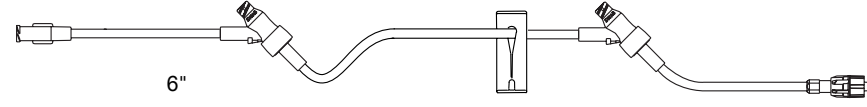
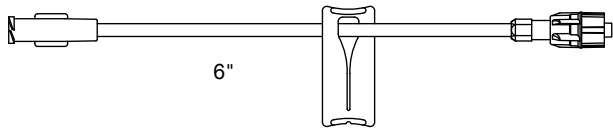
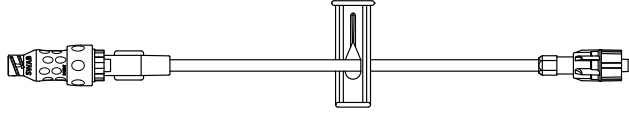
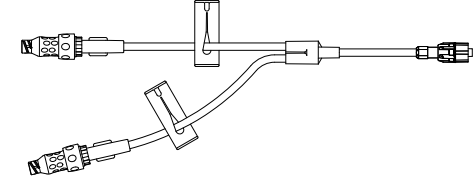
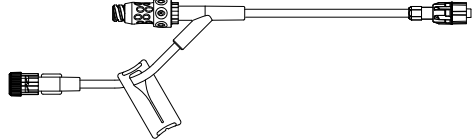
Description	REF Number	Unit Per cs
CARESITE Standard Bore Extension Sets (continued)		
	470124	100
<p>For use with power injectors - maximum 300 psi and maximum flow rate 10 mL/sec Standard bore extension set with bonded CARESITE (LAD) valve, kink-resistant tubing, slide clamp, SPIN-LOCK connector. Not made with DEHP or natural rubber latex. Priming volume: 0.5 mL, Length: 8 in. (20 cm) Power injection rated to 300 psi and 10 mL/sec</p>		
	354219	50
<p>Standard bore extension set with non-removable slide clamp, CARESITE valve injection site, SPIN-LOCK® connector. Not made with DEHP or natural rubber latex. Priming volume: 1.5 mL, Length: 8 in. (20 cm)</p>		
	354220	50
<p>Standard bore extension set with two CARESITE valve injection sites 28 in. and 6 in. above distal end, non-removable slide clamp, SPIN-LOCK connector. Not made with DEHP or natural rubber latex. Priming volume: 5.5 mL, Length: 35 in. (89 cm)</p>		
	480223	50
<p>Standard bore extension set. Female luer connector, fixed slide clamp and SPIN-LOCK connector. Not made with DEHP or natural rubber latex. Priming volume: 0.4 mL. Length: 8 in. (20 cm). Power injection rated to 300 psi and max. flow rate 10 mL/sec.</p>		
	470159	100
<p>Standard bore extension set with removable 8" (20cm) CARESITE injection site, fixed slide clamp and SPIN-LOCK connector. Not made with DEHP or natural rubber latex. Priming volume: 0.5 mL. Length: 8 in. (20 cm) Set rated to 300 psi and max. flow rate 10 mL/sec.</p>		
	470170	50
<p>Standard bore extension set with removable 8" (20cm) CARESITE injection site, fixed slide clamp and SPIN-LOCK connector. Not made with DEHP or natural rubber latex. Priming volume: 0.5 mL. Length: 8 in. (20 cm) Set rated to 300 psi and max. flow rate 10 mL/sec.</p>		
	354251	50
<p>Standard bore high pressure rated Y-extension set with CARESITE valve injection site and SPIN-LOCK® connector. Set rated to 300 psi and max. flow rate 15 mL/sec. Not made with DEHP or natural rubber latex. Priming volume: 0.9 mL. Length: 10 in. (25 cm)</p>		

Description	REF Number	Unit Per cs
-------------	------------	-------------

Filterflow® Filtered Extension Sets with CARESITE Injection Site

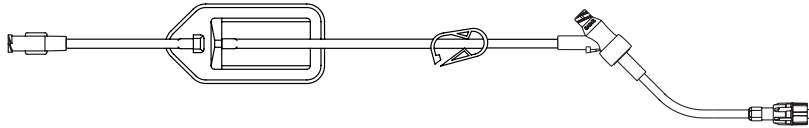

0.2 micron filter, CARESITE valve injection site 6 in. above distal end, on/off clamp, SPIN-LOCK connector. Not made with DEHP or natural rubber latex. Priming volume: 5 mL, Length: 16 in. (40.6 cm)

354221

50

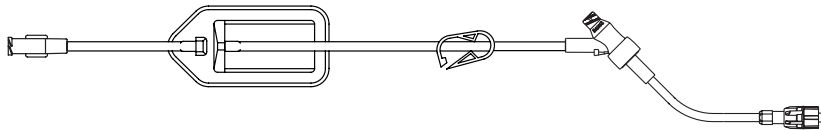

1.2 micron filter, CARESITE valve injection site 6 in. above distal end, on/off clamp, SPIN-LOCK connector. Not made with DEHP or natural rubber latex. Priming volume: 5 mL, Length: 16 in. (40.6 cm)

470117

50

Filterflow Filtered Administration Sets with CARESITE Injection Sites

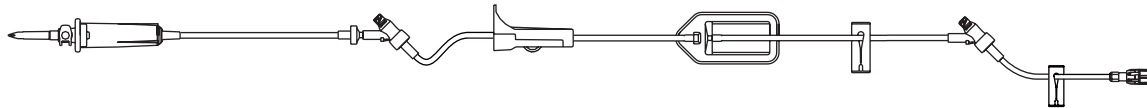

(15 drops/mL) Universal spike, backcheck valve, CARESITE injection sites 87 in. and 6 in. above distal end, roller clamp, 0.2 micron filter, slide clamp, SPIN-LOCK connector. Not made with DEHP or natural rubber latex. Priming volume: 19 mL, Length: 104 in. (264.2 cm)

354207

50

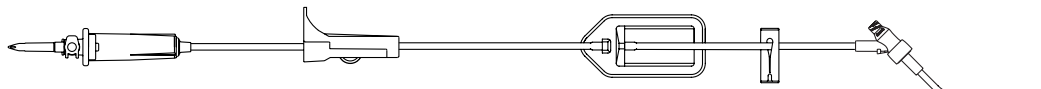

(15 drops/mL) Universal spike, roller clamp, 1.2 micron filter, slide clamp, CARESITE injection site 6 in. above distal end, SPIN-LOCK connector. Not made with DEHP or natural rubber latex. Priming volume: 23 mL, Length 98 in. (248.9 cm)

470115

50

Gravity IV Administration Sets with CARESITE Injection Sites

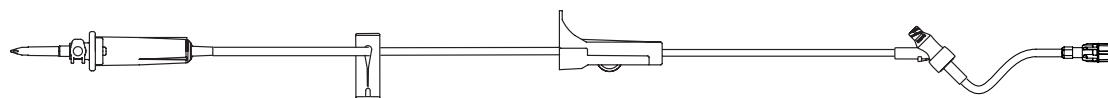

(15 drops/mL) Universal spike, slide clamp, roller clamp, CARESITE injection site 6 in. above distal end, SPIN-LOCK® connector. Not made with DEHP or natural rubber latex. Priming volume: 20 mL, Length: 111 in. (282 cm)

354201

50



(15 drops/mL) Universal spike, backcheck valve, CARESITE valve injection sites 68 in. and 6 in. above distal end, roller clamp, SPIN-LOCK connector. Not made with DEHP or natural rubber latex. Priming volume: 15 mL, Length: 84 in. (210 cm)

354202

50

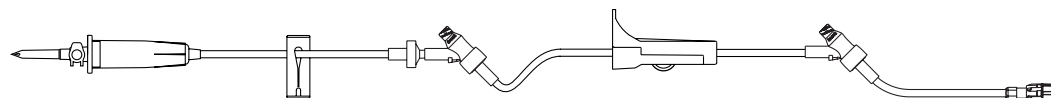

(15 drops/mL) Universal spike, slide clamp, backcheck valve, CARESITE valve injection sites 87 in. and 12 in. above distal end, roller clamp, SPIN-LOCK connector. Not made with DEHP or natural rubber latex. Priming volume: 20 mL, Length: 104 in. (264 cm)

354203

50

CARESITE® LUER ACCESS DEVICE (LAD) SYSTEM

Description	REF Number	Unit Per cs
-------------	------------	-------------

Gravity IV Administration Sets with CARESITE Injection Sites (continued)

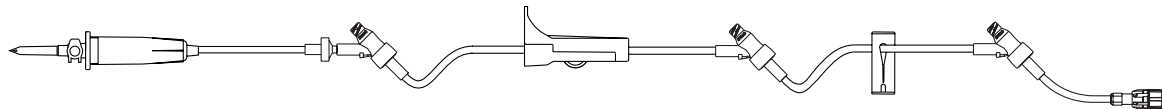

(15 drops/mL) Universal spike, backcheck valve, CARESITE valve injection sites 85 in., 41 in. and 6 in. above distal end, roller clamp, slide clamp, SPIN-LOCK connector. Not made with DEHP or natural rubber latex. Priming volume: 20 mL, Length: 112 in. (285 cm)

354205 50

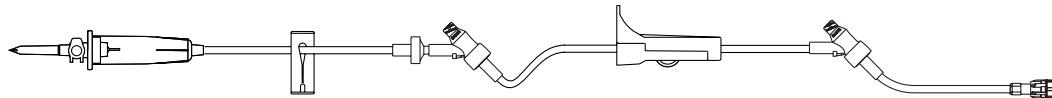

(60 drops/mL) Universal spike, slide clamp, backcheck valve, CARESITE valve injection sites 87 in. and 12 in. above distal end, roller clamp, SPIN-LOCK connector. Not made with DEHP or natural rubber latex. Priming volume: 19 mL, Length: 103 in. (262 cm)

354204 50

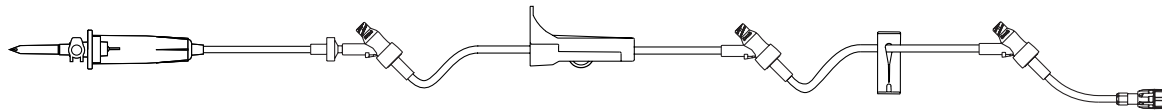

(60 drops/mL) Universal spike, backcheck valve, CARESITE valve injection sites 61 in., 26 in. and 6 in. above distal end, roller clamp, slide clamp, SPIN-LOCK connector. Not made with DEHP or natural rubber latex. Priming volume: 17 mL, Length: 88 in. (223.5 cm)

354206 50

Blood Sets with CARESITE Injection Sites

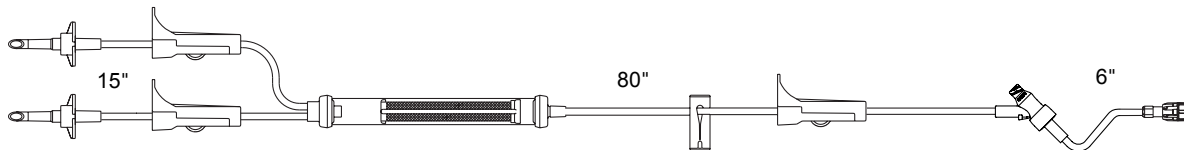

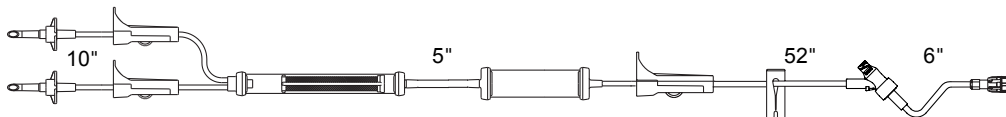

(10 drops/mL) Y-type blood set, non-vented spikes, two upper roller clamps, drip chamber with 170 micron blood filter, integrated free-flow protector/slide clamp, roller clamp, CARESITE valve injection site 6 in. above distal end, SPIN-LOCK® connector. Not made with natural rubber latex. Contains DEHP. Priming volume: 31 mL, Length: 110 in. (279.4 cm)

354217 50

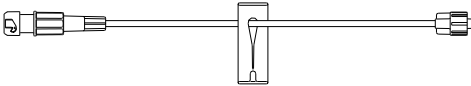
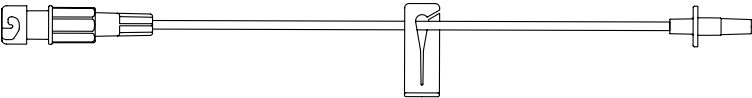
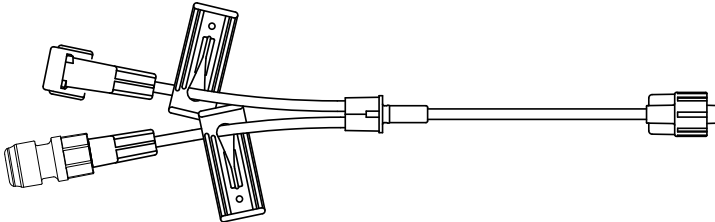

(10 drop/mL) Y-type blood set with two non-vented spikes, 170 micron filter, hand pump, slide clamp, three roller clamps, CARESITE® Luer Access Device, and SPIN-LOCK connector. Not made with natural rubber latex. Contains DEHP. Priming volume: 75 mL, Length: 89 in. (226 cm)

354218 50

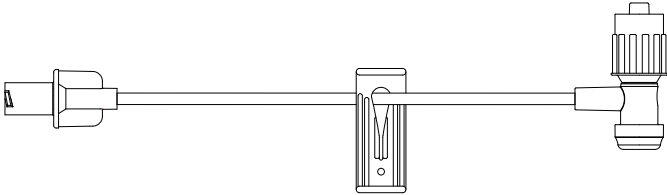
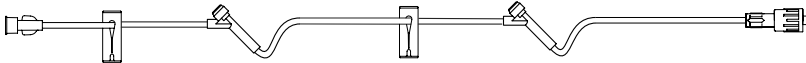
Description	REF Number	Unit Per cs
<p>Extension Sets with SAFELINE Split Septum Injection Sites</p>		
		
<p>SAFELINE split septum injection site, slide clamp, microbore tubing, male luer lock connector. Not made with DEHP or natural rubber latex. Priming volume: 0.42 mL, Length: 7 in. (17.8 cm)</p>	NF1310	50
		
<p>SAFELINE split septum injection site, slide clamp, microbore tubing, male luer slip connector. Not made with DEHP or natural rubber latex. Priming volume: 0.5mL, Length: 8 in. (20.32 cm)</p>	NF1312	50
		
<p>Y-type small bore extension set with attached SAFELINE split septum injection site, female adapter, two slide clamps, male luer lock connector. Not made with DEHP or natural rubber latex. Priming volume: 0.5 mL, Length: 7 in. (17.8 cm)</p>	NF1318	100
		
<p>Small bore extension set with SAFELINE split septum injection site, kink-resistant tubing, slide clamp, SPIN-LOCK® connector. Not made with DEHP or natural rubber latex. Priming volume: 0.63 mL, Length: 7 in. (17.8 cm)</p>	NF1320	50
		
<p>Female adapter, microbore tubing, removable slide clamp, T-connector with SAFELINE split septum injection site., SPIN-LOCK connector. Not made with DEHP or natural rubber latex. Priming volume: 0.27 mL, Length: 6 in. (15.2 cm)</p>	NF1330	50
		
<p>Female adapter, large bore tubing, slide clamp, SAFELINE split septum injection sites 28 in. and 6 in. above distal end, slide clamp, SPIN-LOCK® connector. Not made with DEHP or natural rubber latex. Priming volume: 6.0 mL, Length: 35 in. (89 cm)</p>	NF1370	50

SAFELINE® NEEDLELESS SYSTEM

REF
Number Unit
Per cs

Description

Filterflow® Filtered Add-on Extension Set with SAFELINE Split Septum Injection Site

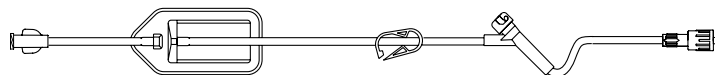

Female luer lock, 0.2 micron filter, SAFELINE split septum injection site 6 in. above distal end, on/off clamp, SPIN-LOCK connector. Not made with DEHP or natural rubber latex. Priming volume: 5.3 mL, Length 16 in. (41 cm)

473993

50

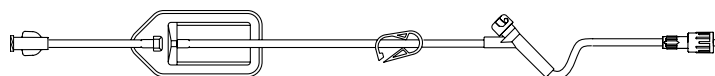

Female luer lock, 1.2 micron filter, SAFELINE split septum injection site 6 in. above distal end, on/off clamp, SPIN-LOCK connector. Not made with DEHP or natural rubber latex. Priming volume: 5.1 mL, Length 16 in. (40.0 cm)

473998

50

Basic Administration Sets with SAFELINE Split Septum Injection Site

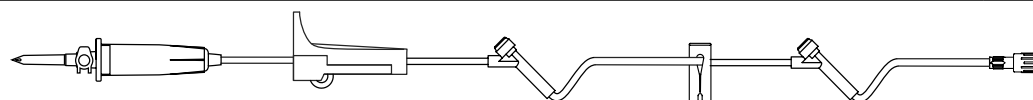

(15 drops/mL) Universal spike, roller clamp, SAFELINE split septum injection sites 40 in. and 6 in. above distal end, slide clamp, SPIN-LOCK connector. Not made with DEHP or natural rubber latex. Priming volume: 19.0 mL, Length: 90 in. (228 cm)

NF1150

50

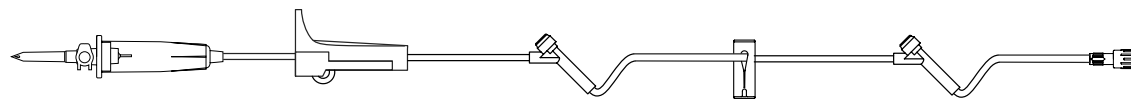

(60 drops/mL) Universal spike, roller clamp, SAFELINE split septum injection sites 38 in. and 6 in. above distal end, slide clamp, SPIN-LOCK connector. Not made with DEHP or natural rubber latex. Priming volume: 18 mL, Length: 94 in. (239 cm)

NF1190

50

Secondary Set for use with SAFELINE Split Septum Injection Site

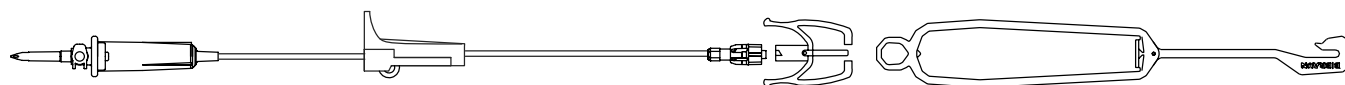

(15 drops/mL) Universal spike, roller clamp, SPIN-LOCK connector, SAFELINE Clip Lock® cannula, 10.5" plastic bag hanger. Not made with DEHP or natural rubber latex. Priming volume: 10.2 mL, Length: 49 in. (125 cm)

NF1430

50

Description	Product Code	REF Number	Unit Per cs
-------------	--------------	------------	-------------

ADDitIV® Primary Administration Sets with Backcheck Valve and SAFELINE Split Septum Injection Sites

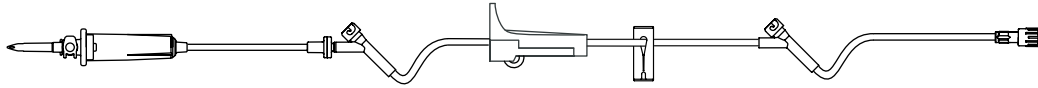

(15 drops/mL) Universal spike, backcheck valve, SAFELINE split septum injection sites 80 in. and 6 in. above distal end, roller clamp, SPIN-LOCK® connector. Not made with DEHP or natural rubber latex. Priming volume: 19 mL, Length: 104 in. (264 cm)

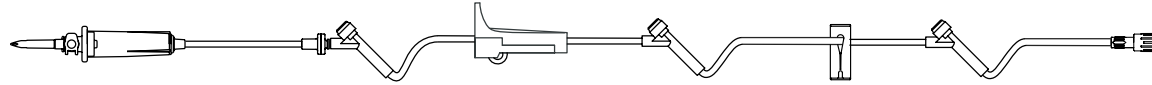

(15 drops/mL) Universal spike, backcheck valve, SAFELINE split septum injection sites 88 in., 30 in. and 6 in. above distal end, roller clamp, slide clamp, SPIN-LOCK connector. Not made with DEHP or natural rubber latex. Priming volume: 19.68 mL, Length: 111 in. (282 cm)

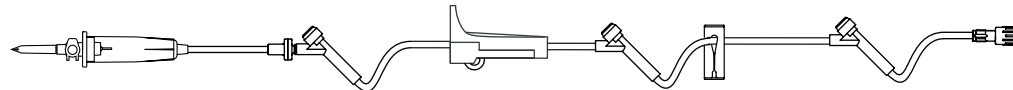

(60 drops/mL) Universal spike, backcheck valve, SAFELINE split septum injection sites 62 in., 27 in. and 6 in. above distal end, roller clamp, slide clamp, SPIN-LOCK connector. Not made with DEHP or natural rubber latex. Priming volume: 17 mL, Length: 88 in. (223.5 cm)

Filterflow® Filtered Gravity Administration Sets with SAFELINE Split Septum Injection Sites

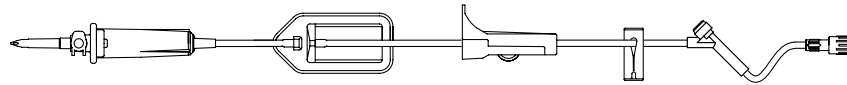

(15 drops/mL) Universal spike, 0.2 micron filter, SAFELINE split septum injection site 6 in. above distal end, SPIN-LOCK® connector. Not made with DEHP or natural rubber latex. Priming volume: 21.0 mL, Length: 89 in. (226 cm)

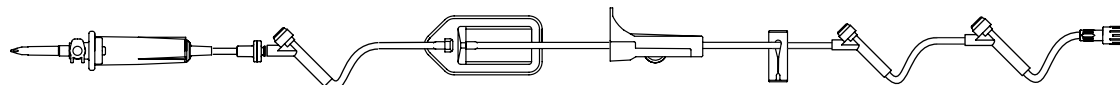

(15 drops/mL) Universal spike, 0.2 micron filter, backcheck valve, SAFELINE split septum injection sites 84 in., 26 in. and 6 in. above distal end, SPIN-LOCK connector. Not made with DEHP or natural rubber latex. Priming volume: 21 mL, Length: 111 in. (281.9 cm)

SAFELINE® NEEDLELESS SYSTEM

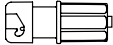
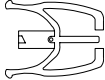
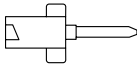
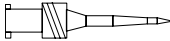
Description	REF Number	Unit Per cs
SAFELINE Needleless Split Septum Injection Site		
 SAFELINE split septum injection site, male luer lock connector. Not made with DEHP or natural rubber latex. Priming volume: 0.25 mL	NF9100	400
Accessories for SAFELINE Split Septum Injection Site		
 SAFELINE Clip Lock® cannula; locking cannula with female luer. Not made with DEHP or natural rubber latex.	NF9200	400
 SAFELINE Blunt Cannula; blunt cannula with female luer. Not made with DEHP or natural rubber latex.	NF9210	400
 Medic® plastic anti-stick needle/connector. Not made with DEHP or natural rubber latex.	M8-5007	1,000

INVISION-PLUS® NEEDLELESS CONNECTOR WITH NEUTRAL ADVANTAGE TECHNOLOGY

The InVision-Plus Needleless Connector with Neutral Advantage Technology is a neutral fluid displacement needleless I.V. connector that combines split septum seal integrity and double microbial barrier with a simple, internal cannula design having no moving parts within the fluid pathway.

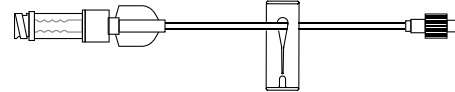
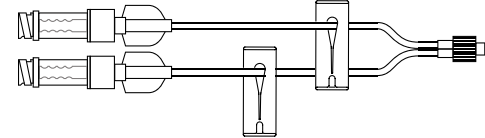
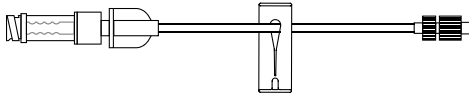
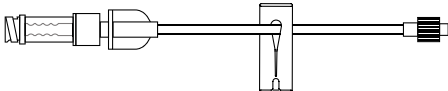
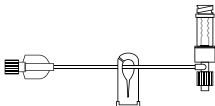
Description	REF Number	Unit Per cs
InVision-Plus Clear PEEL POUCH		
	415303	1,000
<p>Needleless connector for aspiration, injection or gravity flow of fluid upon insertion of a male luer fitting. Components not made with DEHP or natural rubber latex. Priming volume: 0.027 mL. Power injection rated to 325 psi and 10 mL/sec.</p>		
InVision-Plus Extension Sets		
All catheter extension sets are made of kink-resistant, NON-DEHP PVC Tubing.		
	460205	400
<p>Microbore extension set with removable InVision-Plus Clear (LAD) needleless connector, slide clamp, fixed male luer lock connector. Priming volume: 0.27 mL, Length: 7 in. (18 cm)</p>		
	460206	400
<p>Microbore high pressure Y-extension set with two removable InVision-Plus Clear (LAD) needleless connectors, two slide clamps, rotating collar male luer lock. Set rated to 325 psi. Priming volume: 0.45 mL, Length: 7 in. (18 cm).</p>		
	460207	400
<p>Macrobre high pressure extension set with removable InVision-Plus Clear (LAD) needleless connector, slide clamp, universal male luer lock. Set rated to 325 psi. Priming volume: 0.42 mL, Length: 7 in. (18 cm).</p>		
	460208	400
<p>Standard bore extension set with removable InVision-Plus Clear (LAD) needleless connector, slide clamp, fixed collar male luer lock. Priming volume: 1.32 mL, Length: 7 in. (18 cm).</p>		
	460204*	400
<p>Microbore T-Port extension set with removable InVision-Plus Clear (LAD) needleless connector, removable slide clamp, rotating collar male luer lock. Priming volume: 0.26 mL, Length: 4 in. (10 cm).</p>		

General Ordering Information and Terms of Sale

Thank you for your interest in B. Braun Medical Inc. ("B. Braun") products. The following provisions set forth the terms and conditions on which B. Braun sells its products.

Terms of Sale: Purchase of any products sold by B. Braun shall be subject to and expressly limited by the terms and conditions contained herein. No changes to, waiver of, or addition to any of these terms and conditions shall be effective unless agreed to in writing and signed by B. Braun. Buyer acknowledges and agrees that these terms and conditions supersede the terms and conditions of any purchase order or other documentation used by Buyer and, except for delivery and billing addresses, and quantities prices and items ordered, any conflicting or additional terms are void and have no effect, but that Buyer may place orders by use of purchase orders and other documentation for its convenience purposes only. Notwithstanding the foregoing, B. Braun reserves the right at any time to amend these terms and conditions, and Buyer shall be deemed to accept such amended terms and conditions by ordering products herein offered after the date of such amendment. Additional special terms and conditions of B. Braun may be applicable with respect to certain products.

Minimum Order Quantity: All products must be ordered in full case quantities. Orders received with a value of less than \$250.00 will be subject to a handling charge of \$40.00. Wholesalers and Distributors are subject to a handling charge of \$75.00 for orders less than \$1,000.00.

Prices: All pricing quotes must be documented in writing and signed by B. Braun to be valid. Prices quoted, unless otherwise stated, refer to full case quantities. All prices are firm for 30 days from the date quoted. B. Braun reserves the right to change the prices and specifications of its products at any time without notice.

Products purchased from distributors will be at the prices set by those distributors and subject to the terms and conditions of sale of the distributor.

Tax Information: Any tax, assessment, duty, custom or other fee of any nature imposed upon the products, their sale, transportation, delivery, use or consumption shall be paid by Buyer in addition to the price quoted or invoiced. If B. Braun is required to prepay any such tax or fee, Buyer will reimburse B. Braun. Buyer must provide B. Braun with a resale/exemption certificate in order to avoid the withholding of applicable taxes. No refund or adjustment to previously withheld taxes will be made by B. Braun sixty (60) days after the invoice date. Proof of certification should be mailed to: B. Braun Medical Inc., 824 Twelfth Avenue, Bethlehem, PA 18018-0027.

Payment: Payment terms are net 30 days from date of invoice. Credit card payments will not be accepted without prior approval from B. Braun. Buyer's obligation to pay outstanding invoices and all other amounts is absolute and unconditional and is not subject to any abatement, reduction, set-off, defense, counterclaim, interruption, deferment or recoupment for any reason whatsoever. Balances remaining unpaid at due date are subject to a interest charge of **1.5%** per month or the highest rate permitted by law, whichever is lower, until paid.

Any discounts, rebates, administrative fees, credits, or other fees due or owed to Buyer will be applied against delinquent balances before payment or reimbursement is made.

Any disputed amounts should be reported immediately and remitted with the undisputed amount by the payment due date. If B. Braun agrees with the billing dispute, B. Braun will credit Buyer the amount of the agreed-upon billing dispute. All billing disputes must be made within six (6) months of the applicable invoice date, or will be deemed to be waived.

B. Braun reserves the right in its sole discretion to require prepayment from any Buyer at any time and may refuse to sell and/or withhold further shipment until all overdue balances are made current. Buyer shall be liable for, and shall reimburse B. Braun for all costs and expenses it may incur in connection with collection of any amounts owed to B. Braun or enforcement of its rights, including without limitation, reasonable attorneys' fees and expenses, court costs, and cost of collection agencies.

Returned Goods Policy: Product returns are subject to the following conditions:

1. All returns are subject to the prior authorization of B. Braun, in its discretion. Buyer must notify Customer Support at (800) 227-2862 and complete a Return Request Form. The Return Request Form requires lot numbers, quantities and catalog numbers along with a specific reason for return. Customer Support will either authorize or deny the request for return. Only items appearing on an approved Return document are acceptable for return. Product returns will only be accepted from the original purchaser. Product returns will not be accepted from third party return companies. Unauthorized returns will be destroyed and no credit issued. All authorized returned goods must be shipped freight prepaid to the B. Braun location indicated on the Return document, except B. Braun will pay freight costs for Product shipped-in-error.
2. All Products returned within 30 days of delivery are subject to a 25% restocking charge, except for Products shipped-in-error. Products returned after 30 days are considered excess stock and will be eligible for 50% credit. No Products will be accepted for return after 90 days from the date of delivery.
3. Subject to paragraph 2 above, credit will be issued at the net

purchase price for all authorized returns provided:

- a. Products have at least one year shelf-life remaining, or products with original expiration dating of eighteen months or less have at least six months shelf-life remaining.
 - b. Proper authorization has been obtained prior to return of products.
 - c. Products are in their original packaging.
 - d. Products are current inventory items.
 - e. The Products have been shipped and billed to Buyer by B. Braun, and Buyer has paid for said Products.
4. Certain Products **are not eligible for return**. These are:
 - a. Products that have deteriorated because of improper storage, handling, abuse or other factors.
 - b. Products that have been opened, partly used or which the labels or seals have been removed or tampered.
 - c. Products that have been involved in a special promotion sale.
 - d. Broken, damaged or opened cases. Resealed cartons are not eligible for return.
 - e. Special products made to Buyer's specification.
 - f. Sets over two (2) years old, flush syringe products, infusion systems devices, related accessories and IV poles.
 5. Products that are to be returned for repair (e.g., medical device equipment) must be accompanied by an approved Repair Notification.

Expiration Date: On dated products, the expiration date is shown as a month and year, e.g., August 2012, 8/12. The date of expiration is the last day of the given month, e.g., August 31, 2012.

Credits for returned goods are conditioned upon B. Braun's inspection and approval of such goods upon their return. If B. Braun determines, in its discretion, that any returned goods are not eligible for return due to any of the reasons provided in paragraph 4 above, Buyer will not receive a credit, even if an Return document was issued. No advance credits will be accepted.

Warranty: With respect to disposable products, B. Braun warrants to the original purchaser that, at time of delivery, each standard product manufactured by B. Braun shall be free of defects in material and workmanship and, when used for the purposes and indications described on the labeling, is fit for the purposes and indications described on the labeling. All warranties for a product shall expire as of product expiration date, or if none, after one (1) year from the date of shipment from B. Braun. B. Braun's warranty hereunder shall not apply if: (i) a product is not used in accordance with its instructions or if it is used for a purpose not indicated on the labeling, (ii) any repairs, alterations or other work has been performed by Buyer or others on such item, other than work performed with B. Braun's authorization and according to its approved procedures; or (iii) the alleged defect is a result of abuse, misuse, improper maintenance, accident or the negligence of any party other than B. Braun. The warranty set forth herein is conditioned upon proper storage, installation, use and maintenance in accordance with applicable written recommendations of B. Braun. The warranty furnished hereunder does not extend to damage to items purchased hereunder resulting in whole or in part from the use of components, accessories, parts or supplies not furnished by B. Braun.

B. Braun's sole obligation shall be to repair or replace, at B. Braun's option, any defective component or item and pay transportation expenses for such replacement. Buyer shall provide labor for the removal of the defective component or item and installation of its replacement at no charge to B. Braun. Buyer shall bear all risk of loss or damage to returned goods while in transit. In the event no defect or breach of warranty is discovered by B. Braun upon receipt of any returned item, the item will be returned to Buyer at Buyer's expense and Buyer will reimburse B. Braun for the transportation charges, labor and associated charges incurred in testing the allegedly defective item.

Except as expressly provided herein, B. Braun makes no representation or warranty of any kind, expressed or implied with respect to any products, parts or services provided by B. Braun including, but not limited to, the implied warranties of merchantability and fitness for a particular purpose. Products distributed, but not manufactured, by B. Braun are not warranted by B. Braun and Buyer must instead rely on the representations and warranties, if any, provided directly to Buyer by the manufacturer of such product. The sole and exclusive remedy for breach of any warranty is limited to the remedies provided in the paragraph above.

Warranties for infusion system devices are provided in a separate warranty document.

Miscellaneous:

1. Any required notices shall be given in writing, in the case of B. Braun, at the address set forth below, and in the case of Buyer, at the address designated on Buyer's purchase order or to such other address as either party may substitute by written notice to the other and shall be deemed given upon personal delivery, overnight delivery or three days following deposit in the mail.
2. Except as expressly provided herein, no changes or modifications to, or waiver of, any of these terms and conditions shall be valid or binding on either party unless in writing and signed by an authorized representative of each party. B. Braun's failure or delay to exercise or enforce any of its rights hereunder shall not constitute or be deemed to be a waiver of such rights or forfeiture of such rights, and B. Braun may, at its option, from time to time, exercise any of its rights or remedies.
3. These Terms bind Buyer and its successors and permitted assigns.
4. B. Braun will use its reasonable efforts to fill orders, but B. Braun shall not be liable for nonperformance or delays caused by a shortage of raw materials, manufacturing problems, delivery or labor problems, priorities, acts of regulatory agencies or judicial bodies, discontinuation of a product line, acts of God or third parties, infringement claims, or other causes beyond its reasonable control. Buyer agrees that in such events B. Braun may allocate products among all purchasers as it deems reasonable, without liability.
B. Braun reserves the right from time to time to substitute a product with a product that has the same function as such product, or to delete a product.
5. The products are sold subject to Pennsylvania law. These terms and any dispute or claim relating to these terms or the sale of products ("Claim") shall be governed by and construed under Pennsylvania law, notwithstanding its law of conflicts of law. If any Claim cannot be settled amicably between the parties, such Claim shall be tried by a court and not a jury. Buyer expressly and unconditionally waives its rights to a jury trial in any such Claim.
6. B. Braun shall promptly deliver written notice or verbal, followed by written, notice of any recall of Product. Should the recall require Products be removed from the market, B. Braun shall, to the extent reasonably possible and at B. Braun's option, replace any such recalled Products as soon as practicable with comparable Products not subject to such recall or repair any such recalled Products and return them to Buyer.
7. Buyer may not change, adulterate, obscure, remove or deface trademarks, tradenames or labels appearing on any Product of B. Braun.
8. If the pricing offered by B. Braun to a Buyer constitutes a discount or other reduction in price under Section 1128(b)(3)(a) of the Social Security Act 42 U.S.C. 1320a-7b(3)(a), and C.F.R. § 1001.952(h), Buyer shall disclose the discount or reduction in price to the fullest extent required under any state or federal program that provides cost or charge-based reimbursement to Buyers for products. This act requires, among other things, that Buyer fully and accurately report on any claim or request for payment it submits to Medicare and Medicaid the actual purchase price paid by Buyer for products, net of any discounts, rebates or allowances provided hereunder. Buyer may also be required, upon request, to provide documentation of the discount or other reduction in price to the Secretary of Health and Human Services.
9. In all cases, all intellectual property rights in and to, and all technology relating to, the Products supplied to Buyer, their design and all improvements thereto or thereof, whether or not such Product, design or improvement is made pursuant to Buyer's specifications or at Buyer's expense, shall be and remain the exclusive property of B. Braun.
10. Any knowledge or information that Buyer may disclose to B. Braun shall not be deemed to be confidential or proprietary information, and shall be acquired by B. Braun free from any restriction.
11. B. Braun shall not in any event be liable to buyer for any indirect, incidental, special, punitive or consequential damages (including any damage for lost profits), or otherwise arising out of or in connection with furnishing of products, parts or service hereunder, or the performance, use of, or inability to use any products, parts or service, or otherwise, whether based in contract, warranty, tort, including without limitation, negligence, or any other legal or equitable theory. B. Braun's total liability for any claim or action shall not exceed the purchase price of the products out of which such claim or action arose.
12. If any of the products are medical devices, Buyer acknowledges that it is familiar with the Safe Medical Devices Act of 1990 (the "Devices Act") and the reporting obligations imposed on device users thereunder. In this regard, Buyer agrees to notify B. Braun within ten (10) days of the occurrence of any event identified in the Devices Act imposing a reporting obligation on Buyer and/or B. Braun (except for events representing an imminent hazard that require notification to the United States Food and Drug Administration (the "FDA") within seventy-two hours, in which case, such notice will be delivered to the other party immediately).

Buyer shall maintain adequate tracking for the products to enable B. Braun to meet the FDA requirements applicable to the tracking of medical devices.

13. Buyer shall purchase the products for its own use only, and shall not resell the products to any other party. Buyer represents it has examined the products and that they are acceptable and clinically suitable for its intended purposes.

Shipping:

1. Freight charges will be prepaid when orders are shipped via a transportation mode and carrier selected by B. Braun. Unless otherwise stated in an agreement, shipment of infusion systems devices will be made F.O.B. Origin.
2. When expedited delivery, specialized service, or alternate transportation modes are requested, or if requests are inconsistent with efficient distribution practices, an additional charge to cover the premium expense will be added to the invoice. Inside deliveries are subject to additional charges based on current common carrier rates or hourly rates. Palletized deliveries are encouraged.
3. Products will be shipped on a scheduled order and delivery basis. Orders shipped outside Buyer's order and delivery schedule may be subject to a handling charge of \$75.00. B. Braun will provide proof of delivery upon request.

Damage or Loss in Transit: Identity of items and extent of damage or loss must be noted on Buyer's copy of delivery document by the agent of the transportation company. If damage is discovered after receipt of shipment, notify the transportation company immediately and request that inspection be made and an inspection report rendered. Buyer must report concealed shortages or damages within palletized shipments to B. Braun Customer Support within 3 business days of delivery or credit will not be allowed. In addition, Buyer must provide B. Braun with a copy of Buyer's claim request accompanied by a delivery receipt or an inspection report upon which the transportation company has properly noted damage or loss, and B. Braun will issue a credit for the loss or damage and file a claim with the carrier. If such information is not received within ten (10) days of delivery, no credit will be issued.

Send copy of carrier freight bill to Customer Support indicating item and quantity damaged or not received.

Count and inspect your freight before carrier departs. Damaged merchandise should not be accepted.

Please forward all information to Attn: Customer Support, B. Braun Medical Inc., 901 Marcon Blvd., Allentown, PA 18109. (800) 227-2862.

For Order Placement: B. Braun welcomes orders either by telephone, fax, mail or electronically. For telephone orders, please call (800) 227-2862. Faxed orders should be sent to: (610) 266-6122. For infusion devices, call (800) 627-7867 or fax (610) 266-2429. In Canada, please call (800) 624-2920 or fax (800) 624-2939. Mail orders should be directed to Attn: Customer Support, B. Braun Medical Inc., 901 Marcon Blvd, Allentown, PA 18109.

Trademarks

Trademarks of B. Braun Medical Inc. and its affiliates:

ADD-PRO	Cytoguard	Injekt	SPACE	ULTRABLOCK
Adimea	DoseCom	Physiolyte	SAFEPORT	ULTRAPORT
Apex	DoseGuard	PIC	Ster-ASSIST	ULTRAPORT ZerO
AutoCOMPLETE	DoseScan	PinPad	Superset	
B-Smart	EPICAN	QC Tester	Titan XL	
Chemo Dispensing Pin	Flexima	RateGuard	Transofix	
CONTIPLEX	Hyperformer	RED CAP	UniSpike	

Registered trademarks of B. Braun Medical Inc. and its affiliates:

addEASE	Diapact	FreAmine HBC	NephrAmine	PINNACLE	STIMUPLEX
ADDitIV	DISCOFIX	H.E.L.P.	Nutriliplid	Plasmat	TrophAmine
BIG TAB	DoseTrac	HepatAmine	Omnican	PLEXUFIX	ULTRASITE
CAPS	Duosol	Horizon NXT	OMNIFIX	ProcalAmine	VISTA
CARESITE	DUPLEX	HESpan	ONGUARD	Prontosan	WHIN
ClearChoice-DCB	E3	Hyperlyte	Outlook	Rate Flow	
Clip Lock	ESPOCAN	Infusomat	PAB	SAFELINE	
Diacap	EXCEL	Isolyte	PENCAN	SAFSITE	
Diacap a Polysulfone	Filterflow	MICRO PIN	Perfusor	Solcart B	
DiaLines	FILTER STRAW	MINI-SPIKE	PERIFIX	SPIN-LOCK	
Dialog+	FreAmine	MULTI-AD	Physiolyte	SPINOCAN	

BodyGuard, CMExpress and BodyComm and ColorVision are registered trademarks of CME America, LLC.

ChlorPrep and SEPP are registered trademarks of CareFusion 2200, Inc.

DOCit and HubScrub are trademarks of Saxa Medical Solutions.

T-Pak is a registered trademark of Allegiance.

CIV-Flex is a trademark of CIVCO Medical Instruments Company, Inc.

DuraPrep, Steri-Strip and Tegaderm are registered trademarks of 3M.

Medic is a registered trademark of Medisystems Corporation.

Microsoft Access and Windows are registered trademarks of Microsoft Corporation.

Monject is a registered trademark of Covidien, AG.

NeedleVISE is a registered trademark of Atrion Medical Products, Inc.

OmniPal is a trademark and Patient Pal, Trans-Pal, Versa Pole, and Walk 'N' Roller are registered trademarks of Pryor Products, Inc.

OpSite is a registered trademark of T.J. Smith and Nephew, Ltd.

PeraChek, PERACIDIN and PeraSidual are registered trademarks of Angelini Pharma Inc.

Plastipak, SafetyGlide and Vacutainer are registered trademarks of Becton Dickinson and Co.

SAF-T-POLE is a trademark of American Medical Manufacturing, Inc.

SPROTTE is a registered trademark of Pajunk GmbH.

Statlock is a registered trademark of C.R. Bard, Inc.

Steripick, Locksite, Buttonhole, MasterGuard, FingerShield, SecureClip and Streamline are registered trademarks of NxStage Medical, Inc.

SUPOR is a registered trademark of the Pall Corporation.

Tevadaptor is a registered trademark of Teva Medical Ltd.

Trissel's is a trademark of Lawrence A. Trissel.

Velcro is a registered trademark of Velcro Industries B.V.

For more information on IV Sets and Access Devices, call 1-800-227-2862
or visit www.bbraunusa.com.