

CARESCAPE™ V100 Vital Signs Monitor Operator's Manual



Contents

1

Introduction

Description	1-3
Indications for Use	1-3
Contraindication	1-3
Product Compliance	1-6
Symbols	1-7

2

Getting Started

Unpacking the Monitor and Accessories	2-3
Setting up NIBP Connections	2-3
Setting up SpO ₂ Connections	2-4
Setting up Temperature Connections	2-4
Setting up the Printer (Installing the Paper)	2-5
Power Sources	2-5
Turning the Monitor On and Off	2-5
Automatic Shutdown	2-6
When in Clinical Mode	2-6
Procedure for Testing Alarms	2-6
Configuration Mode Settings	2-7
Entering Configuration Mode	2-7
Setting the Date and Time	2-8
Procedures	2-8
SpO ₂ Configuration Settings	2-9
Procedure for Units With Ohmeda TruSignal Technology	2-9
Procedure for Units With Nellcor Technology	2-9
Procedure for Units With Masimo Technology	2-9

3

Product Overview

Buttons	3-3
Front Panel	3-4
Rear Panel	3-5
Right-Side Panel	3-6
Windows	3-6
Indicators	3-6
Operating (System) Modes	3-6
Clinical Mode	3-7
How to enter and exit clinical mode	3-7
To enter clinical mode:	3-7
To exit clinical mode:	3-7
While in clinical mode:	3-7
Configuration Mode	3-7
How to enter and exit configuration mode	3-7
To enter configuration mode:	3-7
To exit configuration mode:	3-7
While in configuration mode:	3-7
Advanced Configuration Mode	3-8
How to enter and exit advanced configuration mode	3-8
To enter advanced configuration mode:	3-8
To exit advanced configuration mode:	3-8
While in advanced configuration mode:	3-8
Service Mode	3-8
Battery Low Shutdown	3-8
System Failure	3-8
User Modes	3-8
Menu Mode	3-9
Inflate Pressure	3-9
Alarm Volume	3-9
Pulse Volume	3-9
Procedure	3-9
Cycle Mode	3-10
Limit Adjustment Mode	3-10
History Mode	3-11
Sounds	3-11
Start-up Sound	3-11
User Interaction Sounds	3-11
Positive Key Tone	3-11
Negative Key Tone	3-11
Alarm Sounds	3-11
High priority	3-11
Medium priority	3-12
Low priority	3-12

Battery Low Shutdown and System Failure Sounds	3-12
Battery Charger Sounds	3-12
Power Sources	3-12
Specifications	3-13

4 Printer

Description	4-3
Installing the Paper	4-3
Print Button	4-3
Printouts	4-4
Current (Real Time)	4-4
Clinical History	4-5
Failure Alarm History	4-5
Paper Storage	4-5
Alarms	4-5
Specifications	4-7

5 Alarms

Description	5-3
Adjusting Alarm Limits	5-3
Alarms Button	5-3
Adjusting the Alarm Volume	5-3
Silencing and Acknowledging an Alarm	5-4
Silence Button	5-4
Alarm Sounds	5-4
Alarms and Priorities	5-4
Limit Alarms	5-5
Parameter Status Alarms	5-5
Printer Alarms	5-5
Memory Alarm	5-6
Battery Alarms	5-6
Remote Alarm	5-6
System Failure	5-6
Alarms	5-7
Factory Defaults	5-8

6

History

Description	6-3
Buttons Associated with History	6-4
Erasing Stored History	6-4
Windows Associated with History	6-4
Indicators Associated with History	6-4

7

NIBP

Description	7-3
What is the Difference Between Intra-Arterial and Auscultatory Methods?	7-4
Oscillometric Method	7-4
Intra-Arterial Reference	7-4
Auscultatory Reference	7-4
Buttons Associated with NIBP	7-6
Inflate/Stop Button	7-6
Cycle Button	7-6
Windows Associated with NIBP	7-7
Indicators Associated with NIBP	7-7
NIBP Modes of Operation	7-8
Manual NIBP Determinations	7-8
Auto Cycle Determinations	7-8
Stat NIBP Determinations	7-9
User Settings	7-9
Mode Settings	7-9
Limit Settings	7-10
Menu Settings	7-10
Sounds Associated with NIBP	7-11
Procedures	7-11
What to do When Taking NIBPs on Different Patients	7-13
Alarms	7-13
Specifications	7-15
Factory Defaults	7-16
GE Medical Systems Information Technologies Patents	7-16

8

Ohmeda TruSignal SpO₂

Description	8-3
TruSignal Enhanced SpO ₂	8-3
PIr pulsatile value	8-3
Configuration Settings Associated with SpO₂	8-5
Buttons Associated with SpO₂	8-5
Windows Associated with SpO₂	8-6
Indicators Associated with SpO₂	8-6
User Settings	8-6
Limit settings	8-6
Menu Settings	8-6
Sounds Associated with SpO₂	8-6
Procedures	8-7
Alarms	8-8
SpO ₂ Hold-off Period	8-8
Alarm Timer	8-8
Specifications	8-9
Factory Default Settings	8-10
GE Medical Systems Information Technologies Patents	8-10
Troubleshooting	8-11

9

Nellcor OXIMAX SpO₂

Description	9-3
Configuration Settings Associated with SpO₂	9-4
SatSeconds™	9-5
Buttons Associated with SpO₂	9-5
Windows Associated with SpO₂	9-5
Indicators Associated with SpO₂	9-5
User Settings	9-6
Limit settings	9-6
Menu Settings	9-6
Sounds Associated with SpO₂	9-6
Procedures	9-6
Alarms	9-8

SpO ₂ Hold-off Period	9-8
Alarm Timer	9-8
Specifications	9-9
Factory Default Settings	9-11
Nellcor Patents	9-11
Troubleshooting	9-13

10 Masimo SET SpO₂

Description	10-3
Indications and Contraindications	10-3
Configuration Settings Associated with SpO ₂	10-6
Buttons Associated with SpO ₂	10-6
Windows Associated with SpO ₂	10-6
Indicators Associated with SpO ₂	10-7
User Settings	10-7
Limit settings	10-7
Menu Settings	10-7
Sounds Associated with SpO₂	10-7
Procedures	10-7
Alarms	10-9
SpO ₂ Hold-off Period	10-9
Alarm Timer	10-9
Specifications	10-11
Factory Default Settings	10-14
Masimo Patents	10-14
Troubleshooting	10-15

11 Alaris Turbo Temp

Description	11-3
Predictive Mode	11-3
Monitor Mode	11-3
Configuration Settings Associated with Temperature	11-5
Buttons Associated with Temperature	11-5
Windows Associated with Temperature	11-5

Indicators Associated with Temperature	11-5
Measurement in Progress Indicators	11-5
Predictive Mode	11-5
Monitor Mode	11-6
Measurement NOT in Progress Indicators	11-6
User Settings	11-6
Menu Settings	11-6
Sounds Associated with Alaris Turbo Temp	11-6
Procedures for Oral Predictive Mode Determinations	11-7
Procedures for Rectal Predictive Mode Determinations	11-8
Procedures for Monitor Mode Determinations (Axillary Determinations)	11-8
Specifications	11-11
Factory Default Settings	11-11
Alaris Patents	11-11

12 Pulse Rate

Description	12-3
Buttons Associated with Pulse Rate	12-3
Windows Associated with Pulse Rate	12-3
Indicators Associated with Pulse Rate	12-4
User Settings	12-4
Limit settings	12-4
Menu Settings	12-4
Sounds Associated with Pulse Rate	12-4
Factory Defaults	12-4

13 Battery

Description	13-3
Buttons Associated With the Battery	13-4
Windows Associated With the Battery	13-4
Indicators Associated With the Battery	13-4
First Use	13-4
Battery Charging	13-4

Disposal of Batteries	13-5
Storage, Care, and Replacement of Batteries	13-5
Alarms	13-6
Battery Low	13-6
When about 45 minutes of battery charge remains:	13-6
When about 5 minutes of battery charge remains:	13-6
When 5 minutes of battery charge expires:	13-6
After plugging the monitor into DC power:	13-6
E13 Battery Low	13-7
Specifications	13-9
Troubleshooting	13-11

A Connections

Connection Details	A-3
Host Port Connector (rear panel)	A-3

B Accessories

Accessories	B-3
--------------------------	------------

C Maintenance

Assistance and Parts	C-3
Maintenance, Calibration, and Cleaning	C-3
Calibration and Leak Testing	C-3
Cleaning	C-3
Cleaning the Monitor	C-3
Monitor Exterior	C-4
Never use the following cleaning agents:	C-4
Monitor Display	C-4
Cuff Cleaning and Disinfection	C-5
General	C-5
Procedure	C-5
Temperature Devices	C-6
SpO ₂ Sensors	C-6
Battery and Storage Care	C-6
Replacing the Battery	C-7
Repairs	C-8
Packaging Material	C-9

Packing Instructions	C-9
Disposal of Product Waste	C-9
Batteries	C-9
Patient Applied Parts	C-9
Monitor	C-10

D

Principles of NIBP Determination

DINAMAP SuperSTAT Algorithm	D-3
Systolic Search	D-4
DINAMAP Classic and Auscultatory Reference Algorithm	D-5
Systolic Search	D-6
Reference Used to Determine NIBP Accuracy	D-6
CARESCAPE V100 Monitors With Intra-Arterial Reference (DINAMAP SuperSTAT and Classic Technology)	D-7
CARESCAPE V100 Monitors With Auscultatory Reference (DINAMAP Auscultatory Reference Technology)	D-7

CARESCAPE™ V100 Vital Signs Monitor Operator's Manual



NOTE: The information in this manual also applies to CARESCAPE V100 Vital Signs Monitor software version RAA. There are no user-apparent differences among these software versions. Due to continuing product innovation, specifications in this manual are subject to change without notice.

NOTE: For technical documentation purposes, the abbreviation GE is used for the legal entity name, GE Medical Systems *Information Technologies*.

Listed below are GE Medical Systems *Information Technologies* trademarks. All other trademarks contained herein are the property of their respective owners.

Ohmeda Oximetry and other trademarks (OxyTip+, Plr, TruSat, TruSignal, TruTrak+) are the property of GE Medical Systems *Information Technologies*, a division of General Electric Corporation. All other product and company names are the property of their respective owners.

Alaris Turbo Temp and IVAC are trademarks of Cardinal Health, Inc.

CRITIKON, DINAMAP, SuperSTAT, and DURA-CUF and SOFT-CUF Blood Pressure Cuffs are trademarks of GE Medical Systems *Information Technologies*.

Masimo SET, LNOP, and LNCS are trademarks of Masimo Corporation. Possession or purchase of this device does not convey any express or implied license to use the device with replacement parts which would, alone, or in combination with this device, fall within the scope of one or more of the patents relating to the device.

Nellcor, OxiMax, C-LOCK and *SatSeconds* are trademarks of Nellcor Puritan Bennett.

1 Introduction



CARESCAPE V100 Vital Signs Monitor

Description

The CARESCAPE V100 Vital Signs Monitor provides a small, portable, easy-to-use monitoring alternative for sub-acute hospital and non-hospital settings. The V100 is for use on adult, pediatric, or neonatal patients—one at a time. The battery-operated monitor offers noninvasive determination of systolic blood pressure, diastolic blood pressure, mean arterial pressure, pulse rate, oxygen saturation, and temperature. Monitors are available with or without integrated printers as well as the following parameters and technologies.

- NIBP, Pulse: SuperSTAT, Auscultatory, Classic
- SpO₂: Ohmeda TruSignal, Nellcor, or Masimo
- Temperature: Alaris Turbo Temp

The model of the monitor determines which parameters are in your monitor. Please refer to applicable sections.

Using the V100 Monitor, a clinician can measure, display, and record patient vital sign data that is derived from each parameter. The monitor is also capable of alerting the clinician to changes in the patient's condition or when it is unable to effectively monitor the patient's condition. All of the main operations of the V100 Monitor are easy-to-use and only a button-touch away. Please review the factory default settings and, where applicable, enter settings appropriate for your use.

Indications for Use

The CARESCAPE V100 Vital Signs Monitor is for use as prescribed by physicians, physician assistants, registered nurses, certified registered nurse anesthetists, or other qualified medical personnel trained in the use of the equipment. The V100 is intended to monitor and measure oscillometric noninvasive blood pressure (systolic, diastolic, and mean blood pressure), heart rate/pulse, oxygen saturation (SpO₂) by noninvasive pulse oximetry, and predictive temperature with an electronic thermometer. The CARESCAPE V100 also detects alarm limit conditions and gives audible and visual notification of these conditions. Using this monitor, a clinician can view, record, and recall clinical data derived from each parameter.

V100 Monitors are intended for use in various markets, from the physician's office to sub-acute triage and medical/surgical units. The CARESCAPE V100 is intended to monitor one patient at a time in a clinical setting.

Contraindication

This device is not designed, sold, or intended for use except as indicated.

WARNINGS

Do not use the V100 Monitor in the presence of magnetic resonance imaging (MRI) devices. There have been reports of sensors causing patient burns when operating in an MRI environment.

Do not use the monitor in the presence of flammable anesthetics.

The use of approved accessories will provide protection from burns during HF surgery. To help prevent unintended current return paths with the use of high frequency (HF) surgical equipment, ensure that the HF surgical neutral electrode is properly connected.

To avoid personal injury, do not perform any servicing unless qualified to do so.

These Monitors should not be used on patients who are connected to cardiopulmonary bypass machines.

If powering the monitor from an external power adapter or converter, use only GE Medical Systems *Information Technologies*-approved power adapters and converters.

The monitor does not include any user-replaceable fuses. Refer servicing to qualified service personnel.

To reduce the risk of electric shock, do not remove the cover or the back. Refer servicing to a qualified service person.

If the accuracy of any determination reading is questionable, first check the patient's vital signs by alternate means and then check the V100 Monitor for proper functioning.

Use of portable phones or other radio frequency (RF) emitting equipment near the system may cause unexpected or adverse operation.

The equipment or system should not be used adjacent to, or stacked with, other equipment. If adjacent or stacked use is necessary, the equipment or system should be tested to verify normal operation in the configuration in which it is being used.

The use of accessories, transducers and cables other than those specified may result in increased emissions or decreased immunity performance of the equipment or system.

CAUTIONS

Federal law (U.S.A.) restricts this device to sale by or on the order of a physician.

Do not use replacement batteries other than the type supplied with the monitor. Use only batteries recommended by GE Medical Systems *Information Technologies*. Other batteries could result in monitor shut down. Replacement batteries are available from GE Medical Systems *Information Technologies-Accessories and Supplies*.

The V100 Monitor is designed to conform to Electromagnetic Compatibility (EMC) standard IEC 60601-1-2, 1993 and will operate accurately in conjunction with other medical equipment which also meets this requirement. To avoid interference problems affecting the monitor, do not use the monitor in the presence of equipment which does not conform to these specifications.

Place the V100 Monitor on a rigid, secure surface. The monitor must only be used with mounting hardware, poles, and stands recommended by GE Medical Systems *Information Technologies*.

The weight of the accessory basket contents should not exceed 5 lb (2.7kg).

Arrange the external AC/DC power converter, air hoses, and all cables carefully so they do not constitute a hazard.

Verify calibration of NIBP parameter (temperature and pulse oximeter do not require calibration; refer to the service manual for instructions). Ensure that the display is functioning properly before operating the V100 Monitor.

Do not immerse the monitor in water. If the monitor is splashed with water or becomes wet, wipe it immediately with a dry cloth.

Do not gas sterilize or autoclave.

Examine the power cord periodically. Discontinue use and replace if damaged.

Caution should be taken to not set ALARM LIMITS to extreme values, as this can render the ALARM SYSTEM useless.

The V100 Monitor, when used with GE Medical Systems *Information Technologies*-approved applied parts and accessories, is protected against defibrillator damage.

NOTE: The electromagnetic compatibility profile of the V100 Monitor may change if accessories other than those specified for use with the V100 Monitor are used. Please refer to Appendix B "Accessories."

Product Compliance

The CARESCAPE V100 Monitor is classified in the following categories for compliance with IEC 60601-1:

- Internally powered or Class II when powered from external supply
- Transportable
- For continuous operation
- Not suitable for use in the presence of flammable anesthetics
- Not for use in the presence of an oxygen-enriched atmosphere (oxygen tent)
- Type BF applied parts
- IPX1, degree of protection against ingress of water
- Sterilization/Disinfection, see Appendix C *"Maintenance"*
- Software is developed in accordance with IEC 60601-1-4.
- This equipment is suitable for connection to public mains via power adaptors as defined in CISPR 11.
- The SpO₂ parameter complies to ISO 9919:2005.
- Defibrillation protected. When used with the recommended accessories, the monitor is protected against the effects of defibrillator discharge. If monitoring is disrupted by the defibrillation, the monitor will recover.



CARESCAPE V100 Monitor Classified with respect to electric shock, fire, and mechanical and other specified hazards only in accordance with CAN/CSA C22.2 No. 60601.1. Also evaluated to IEC-60601-2-30.



This product conforms with the essential requirements of the Medical Device Directive 93/42. Accessories without the CE mark are not guaranteed to meet the Essential Requirements of the Medical Device Directive.

IPX1

The CARESCAPE V100 Monitor is protected against vertically falling drops of water and conforms with the IEC 529 standard at level of IPX1. No harmful effects will come of vertically falling drops of water making contact with the monitor.

Symbols

The following symbols are associated with the V100 Vital Signs Monitor.

NOTE: The model of the monitor determines which symbols appear on it.



Attention, consult accompanying documents



Silence



Alarms



+ / - Increase / decrease adjustable settings



Menu



Inflate/Stop



Cycle



History



Print



On/Off



Battery Power



External communications port connector



Charging



External DC power input



Class II equipment according to IEC 60536



Defibrillator-proof type BF equipment

Introduction: Symbols



WASTE OF ELECTRICAL AND ELECTRONIC EQUIPMENT (WEEE): This symbol indicates that the waste of electrical and electronic equipment must not be disposed as unsorted municipal waste and must be collected separately. Please contact an authorized representative of the manufacturer for information concerning the decommissioning of your equipment.



Manufacturer: This symbol is accompanied by the name and the address of the manufacturer.



Manufacturing Date: This symbol is accompanied by the date of the manufacturing.

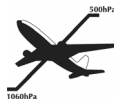

Packaging label depicting the transportation and storage atmospheric pressure range of 500 to 1060 hPa.

2 Getting Started

For your notes

Unpacking the Monitor and Accessories

Before attempting to use the V100 Monitor, take a few minutes to become acquainted with the monitor and its accessories. Unpack the items carefully. This is also a good time to check for any damage or accessory shortage. If there is a problem or shortage, contact GE Medical Systems *Information Technologies*.

It is recommended that all the packaging be retained, in case the monitor must be returned for service in the future.

Setting up NIBP Connections

1. Connect the end of the air hose that has quick-release clips to the NIBP connector on the front of the monitor. Make sure that the hose is not kinked or compressed.

NOTE: To disconnect the hose from the monitor, squeeze the quick-release clips together and pull the plug from the NIBP connector.

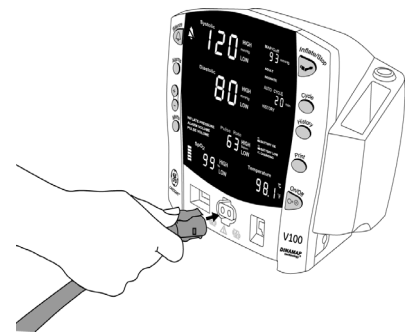

2. Select appropriate cuff size. Measure patient's limb and select appropriately sized cuff according to size marked on cuff or cuff packaging. When cuff sizes overlap for a specified circumference, choose the larger size cuff.

CAUTION

Accuracy depends on use of proper size cuff.

3. Inspect cuff for damage. Replace cuff when aging, tearing, or weak closure is apparent. Do not inflate cuff when unwrapped.

CAUTION

Do not use cuff if damaged.

4. Connect the cuff to the air hose. Refer to the "NIBP" Section for complete cuff connection instructions.

WARNING

It is mandatory that the appropriate hose and cuff combination be used. Any attempt to modify the hose will inhibit the monitor from switching between the neonate and adult/ped measurement modes.

NOTE: Care should be taken in reconnecting the cuff to a hose, ensuring that threads of the cuff and hose are in alignment and no cross-threading occurs.

5. Refer to the “NIBP” Section of this manual for complete instructions on taking an accurate NIBP determination.

NOTES

- ◆ Use only GE CRITIKON BP cuffs. The size, shape, and bladder characteristics can affect the performance of the instrument. Inaccurate readings may occur unless GE CRITIKON BP cuffs are used. Refer to Appendix B “Accessories” for reorder codes.
- ◆ The **ADULT** indicator encompasses both adult and pediatric patients.

Setting up SpO₂ Connections

1. Plug the appropriate SpO₂ sensor into the SpO₂ sensor extension cable.
2. Then plug the SpO₂ sensor extension cable into the SpO₂ sensor connector on the monitor.

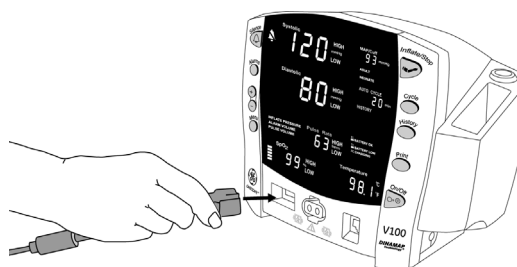

3. Refer to the applicable “SpO₂” Section of this manual for complete instructions on monitoring SpO₂.

Setting up Temperature Connections

1. Connect the temperature probe cable to the temperature probe connector on the monitor.
2. Insert the temperature probe into the probe holster at the side of the monitor.
3. Refer to the “Alaris Turbo Temp” Section of this manual for complete instructions on taking a temperature reading.

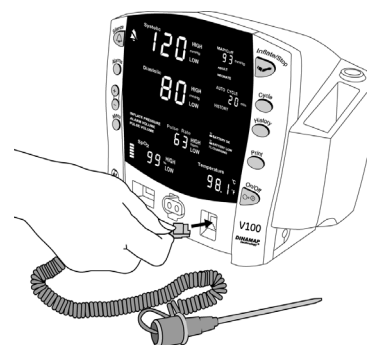

Setting up the Printer (Installing the Paper)

1. With the monitor powered on, turn it so that the side with the printer is facing you.
2. While grasping the side of the monitor, lift the printer door open by placing your thumb in the indented area and pulling. The printer door will pop open.

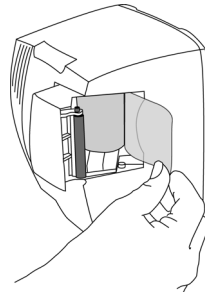
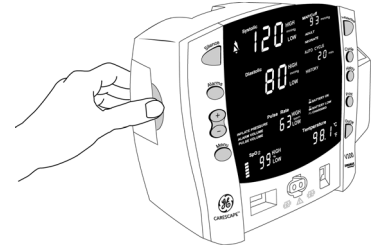

3. Place the roll of paper into the compartment so that the end of the paper comes off the right-side of the roll (paper is wound around the roll clockwise). Push the roll all the way to the back of the printer cavity, making sure the paper extends out of the printer cavity at least two inches.
4. Firmly press the door to close it.

Power Sources

The V100 Monitor is designed to operate from an internal battery (see *Specifications* in “*Product Overview*” Section). The V100 Monitor is not designed to operate without an internal battery. With external DC power connected, the green  **CHARGING** indicator will light to indicate that the battery is charging.

NOTES

- Prior to each use, inspect the power supply cord to ensure proper connection and condition.
- Be sure to unplug the power supply from the AC outlet before transport.

Turning the Monitor On and Off



To turn the V100 Monitor on, push the power **On/Off** button. As the monitor powers up, it runs a short self-test (display test) in which all seven-segment indicator lights illuminate. When the monitor is powered on, it generates a start-up sound. This start-up sound consists of 5 separate tones generated in succession.

WARNINGS

If any of the seven-segment indicator lights fail to illuminate during the display test, the accuracy of vital sign values could be misread. Contact GE Medical Systems *Information Technologies* Technical Support.

If the monitor fails to sound the start-up tones, do not use the monitor. This indicates problems with the audible alarm circuit. Contact GE Medical Systems *Information Technologies* Technical Support.

To turn the monitor off, push the power **On/Off** button again. This will terminate any measurements that may be in progress and automatically deflate the cuff.

Automatic Shutdown

The V100 has an automatic shutdown feature in order to conserve battery life.

When in Clinical Mode

In clinical mode, the monitor automatically shuts down after an inactive period of 15 minutes.

Certain conditions or actions that can delay or disable auto shutdown are:

- The monitor is operating on external DC power.
- The SpO₂ parameter is monitoring vitals.
- The NIBP mode of operation is auto or Stat mode.
- An NIBP determination is in progress.
- Any alarm other than **BATTERY LOW** or **E13 BATTERY LOW** is active.
- Any remote command/request is received via the host communications protocol.
- A temperature determination is in progress.
- A button is pressed.
- The monitor is in configuration or advanced configuration mode.

In configuration and advanced configuration modes, pressing any button will delay auto shutdown. The monitor automatically shuts down after an inactive period of 15 minutes even if powered by external DC power.

Procedure for Testing Alarms

1. With the monitor on and the NIBP hose NOT connected to the front of the monitor, press the **Inflate/Stop** button.
2. Verify that after approximately 15 seconds the alarm sounds and the monitor generates an E8 alarm.
3. To clear the alarm, press the **Silence** button.

Configuration Mode Settings

Monitor settings such as **HIGH/LOW** alarm settings changed in the clinical mode will not be retained after the monitor is powered off. To retain alarm and parameter settings, the changes must be done in the configuration mode. Date/Time settings are also entered in the configuration mode.

Entering Configuration Mode

1. With the monitor off, press and hold the **Menu** button at the same time as pressing the **On/Off** button until the display test completes.

NOTE: CFG displays in the **Systolic** window.

As the monitor turns on in the configuration mode, a brief display appears showing the software revision and the NIBP technology of the monitor. These displays appear only during the first part of the power up sequence and are not selectable and cannot be changed.

Display	Window
Major software revision	Systolic
Minor software revision	Diastolic
Type of NIBP technology	min

The Menu selections appear in the following order. Refer to each manual section for settings options.

Menu selections for SpO₂ differ depending upon the technology. Refer to the "Ohmeda TruSignal SpO₂," "Masimo SpO₂," and "Nellcor SpO₂," Sections for options.

Setting	Setting LED Window	LED Display
Inflate pressure (adult/ped)	Systolic	XXX (numeric)
Inflate pressure (neonate)	Systolic	XXX (numeric)
Line frequency mode (Ohmeda TruSignal only)	SpO ₂	<i>LF</i>
SpO ₂ mode (Nellcor & Masimo only)	SpO ₂	<i>NOd</i>
SpO ₂ sat (Nellcor & Masimo only)	SpO ₂	<i>SAt</i>
SpO ₂ sensitivity (Masimo only)	SpO ₂	<i>SEn</i>

Setting	Setting LED Window	LED Display
Temperature	°C or °F	<i>U_nt</i>
Year	Systolic	<i>Y_r</i>
Month	MAP/Cuff	<i>M_tH</i>
Day	Diastolic	<i>d_AY</i>
Hour	min	<i>H_r</i>
Minute	min	<i>M_in</i>
Mode (when main screen is active)	Systolic	<i>CFG</i>

Setting the Date and Time

To set the date and time on the V100 Monitor, you must access the configuration mode. Press **Menu** to skip the default settings that do not require changes. Refer to the above table.

NOTE: While in configuration mode, all entries stored in the clinical history are erased when the time and/or date is changed.

Procedures

1. Press the **Menu** button to move from one setting to another. Use the **+/-** buttons to increment or decrement the setting.
NOTE: For the date and time to be saved, you must advance the menu through the minute setting.
2. To exit the configuration mode, press the **On/Off** button.
3. To continue with other changes, press the **Menu** button. **CFG** appears in the **Systolic** window. To change parameter settings, press the **Menu** button and select the parameter function. To change alarm settings, press the **Alarms** button.

SpO₂ Configuration Settings

Procedure for Units With Ohmeda TruSignal Technology

(Refer to the "Ohmeda TruSignal SpO₂" Section for options)

1. With the monitor off, press and hold the **Menu** button at the same time as pressing the **On/Off** button until the display test completes.
2. Press the **Menu** button until **LF** appears in the **Pulse Rate** window.
3. Use the **+/-** buttons to select the option.
4. To exit the configuration mode, turn the unit off. To continue with additional configuration settings, press the **Menu** button.

Procedure for Units With Nellcor Technology

(Refer to the "Nellcor SpO₂" Section for options)

1. With the monitor off, press and hold the **Menu** button at the same time as pressing the **On/Off** button until the display test completes.
2. Press the **Menu** button until **nOd** (response mode) appears in the **Pulse Rate** window.
3. Use the **+/-** buttons to select the option.
4. Press the **Menu** button once. **SAt** (SatSeconds) appears in the **Pulse Rate** window.
5. Use the **+/-** buttons to select the option.
6. To exit the configuration mode, turn the unit off. To continue with additional configuration settings, press the **Menu** button.

Procedure for Units With Masimo Technology

(Refer to the "Masimo SpO₂" Section for options)

1. With the monitor off, press and hold the **Menu** button at the same time as pressing the **On/Off** button until the display test completes.
2. Press the **Menu** button until **nOd** (averaging time) appears in the **Pulse Rate** window.
3. Use the **+/-** buttons to select the option.
4. Press the **Menu** button once. **SAt** (FastSAT) appears in the **Pulse Rate** window.
5. Use the **+/-** buttons to select the option.
6. Press the **Menu** button once. **SEn** (sensitivity mode) appears in the **Pulse Rate** window.
7. Use the **+/-** buttons to select the option.
8. To exit the configuration mode, turn the unit off. To continue with additional configuration settings, press the **Menu** button.

3 Product Overview

For your notes

Buttons

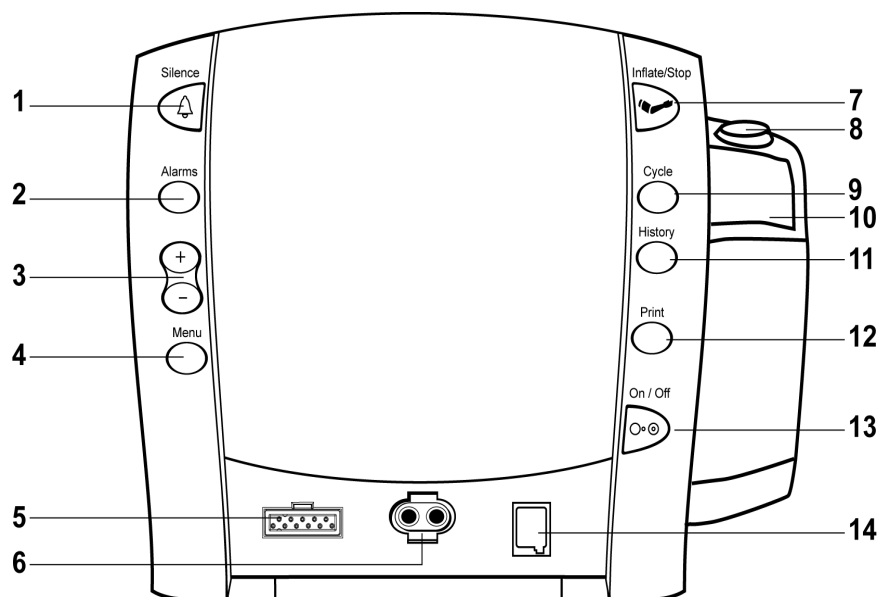

1. **Silence** button: mutes audible alarms. Any other active alarm that can be acknowledged is also removed whenever this key is pressed. When pressed, the silence icon (bell) lights red to indicate that audible alarms have been silenced for 2 minutes. Alarm silence can be cancelled by pressing the **Silence** button again.
2. **Alarms** button: used to view or adjust parameter alarm limit settings.
3. **+/-** buttons (Plus/Minus): used when you are in the following modes: limit, menu, cycle, and history. When you are in limit or menu setting, pressing the **+/-** button increases and decreases an adjustable setting. When you are in cycle or history mode, pressing the **+/-** buttons displays the next or previous cycle selection or entry in the history list, respectively. When you reach the beginning or ending of a list, a negative key-click sounds.
4. **Menu** button: accesses menu settings that can be adjusted: **INFLATE PRESSURE (ADULT and NEONATE), ALARM VOLUME, and PULSE VOLUME.** (Refer to *Operating Modes* in this section for a description of clinical mode.)
NOTE: **ADULT** indicator encompasses both adult and pediatric patients.
5. SpO₂ sensor connector: attach SpO₂ cables here.
6. NIBP connector: attach NIBP cuff hoses here.
7. **Inflate/Stop** button: starts a manual NIBP determination or stop any NIBP determination.
8. Temperature probe holster: stores temperature probe.
9. **Cycle** button: used to select NIBP mode of manual, auto cycle, or Stat mode.
10. Temperature probe cover storage: stores probe covers.
11. **History** button: activates the history mode to view stored patient data. The most recent entries are displayed first. Press and hold the button for 2 seconds to clear all entries stored; the adaptive inflate pressure setting returns to the configured setting. Refer to the "History" Section of this manual for more information.

12. **Print** button: prints currently displayed values or all stored entries when in history mode.
13. **On/Off** button: controls on/off state of monitor; push for power on and push again for power off.
14. Temperature probe connector: attach temperature probe cable here.

Front Panel

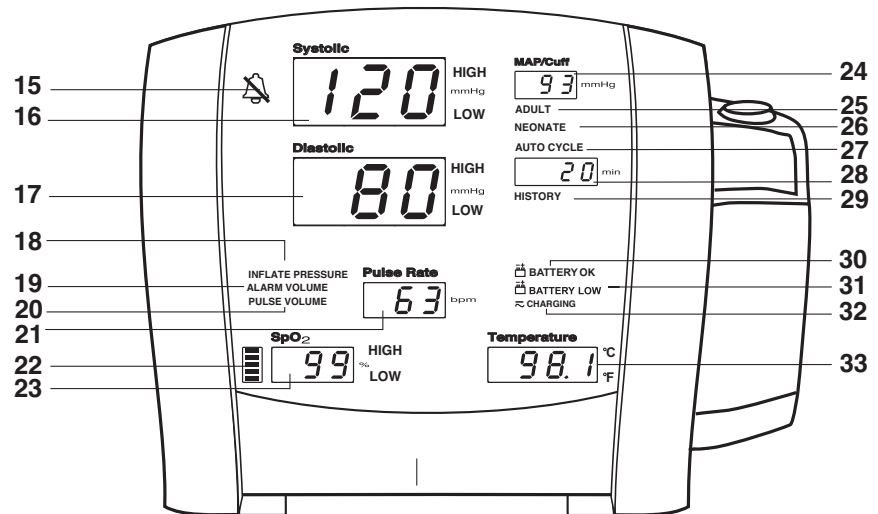

15. **Silence** icon: silences audible alarms for 2 minutes; silence icon (bell) lights.
16. **Systolic** window: indicates measured systolic NIBP in mmHg.
17. **Diastolic** window: indicates measured diastolic NIBP in mmHg.
18. **INFLATE PRESSURE** indicator: flashes to indicate you are making a change to the inflation pressure. Adjustable for adult/ped and neonate patients.
19. **ALARM VOLUME** indicator: flashes to indicate you are making a change to the alarm volume.
20. **PULSE VOLUME** indicator: flashes to indicate you are making a change to the pulse volume.
21. **Pulse Rate** window: shows pulse rate in beats per minute.
22. SpO₂ pulse indicator: flashing red LED bar indicates that pulses are being derived from SpO₂ signals.
23. **SpO₂** window: indicates oxygen saturation in %.
24. **MAP/Cuff** window: indicates measured mean arterial pressure (MAP) in mmHg and shows cuff pressure during NIBP determination.
25. **ADULT** indicator: lights to indicate you are making a change to adult/ped NIBP limits or inflation pressure settings.
26. **NEONATE** indicator: lights to indicate you are making a change to neonate NIBP limits or inflation pressure settings.

- 27. **AUTO CYCLE** indicator: lights green to indicate auto mode is the chosen NIBP mode; flashes to indicate you are making a change to the auto mode.
- 28. **Min** window: displays the NIBP mode if manual or Stat as well as the cycle time when taking auto NIBP determinations.
- 29. **HISTORY** indicator: flashes to indicate you are in history mode.
- 30. **BATTERY OK** indicator: lights green to indicate the monitor is operating on battery power and that the battery is sufficiently charged.
- 31. **BATTERY LOW** indicator: lights amber to indicate low charge for the battery (45 min or less when solid; 5 min or less when flashing).
- 32. **CHARGING** indicator: lights green to indicate presence of external power source and battery charging.
- 33. **Temperature** window: lights 4-digit red LED to indicate measured temperature.

Rear Panel

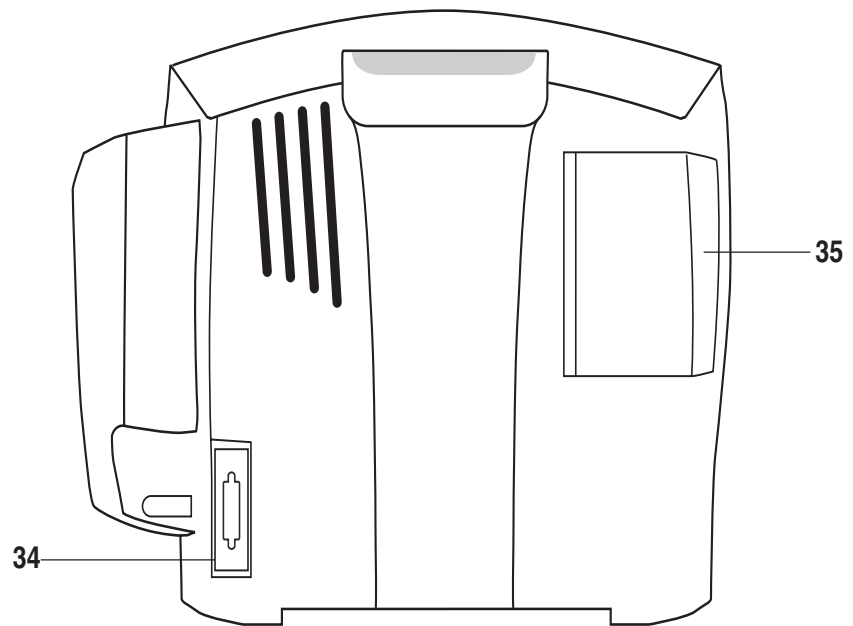

- 34. Data interface connector: host communications port (15 pin D-type RS-232 serial port) for use only with equipment conforming to IEC 60601-1, configured to comply with IEC 60601-1-1.
- 35. Printer door.

Right-Side Panel

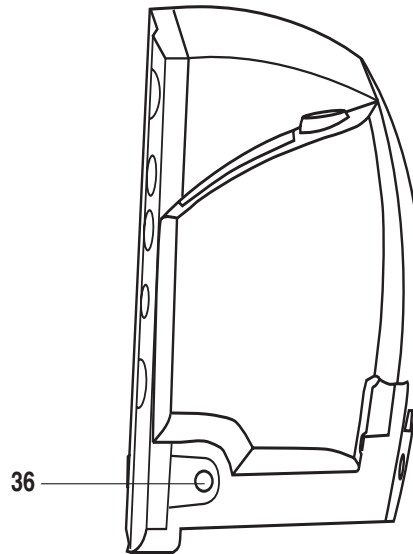

36. External DC power socket: used with approved GE Medical Systems *Information Technologies* AC-DC power converter ONLY.

Windows

Each derived vital sign has an associated window for displaying the value. For each window, the vital sign's name and unit of measure are labeled above and to the right of it, respectively. An additional window--the **min** window--is available for displaying the NIBP mode or chosen **AUTO CYCLE** selection.

Indicators

Indicators are text messages and icons that are positioned on the front of the monitor. Each indicator can be backlit one color, either red, green or amber. Indicators are described in the appropriate sections throughout this manual.

Operating (System) Modes

The V100 Monitor can operate in one of six modes:

- Clinical
- Configuration
- Advanced configuration
- Service
- Battery low shutdown
- System failure

Clinical Mode

Clinical mode is the mode used to monitor patients.

How to enter and exit clinical mode

To enter clinical mode:

- With the monitor off, press the **On/Off** button.

To exit clinical mode:

- With the monitor on, press the **On/Off** button for less than 5 seconds.

While in clinical mode:

- All parameters are available for monitoring.
- Alarm limits and all user settings are adjustable.

Configuration Mode

Configuration mode is used for configuring or customizing how the monitor operates in clinical mode. Configuration mode briefly displays the software revision in the **Systolic** and **Diastolic** windows and the configured NIBP technology in the **min** window.

How to enter and exit configuration mode

To enter configuration mode:

- With the monitor off, press the **On/Off** button at the same time as pressing and holding the **Menu** button.

To exit configuration mode:

- With the monitor on, press the **On/Off** button for less than 5 seconds.

While in configuration mode:

- All parameters are inoperable.
- The **Systolic** window displays **CFG** indicating the monitor is in configuration mode.
- Applicable default settings are configurable to their user-preferred default settings.

CAUTION

No parameters are operable in these modes, therefore, patient monitoring should be suspended.

Advanced Configuration Mode

Advanced configuration is used for configuring the monitor's serial port communication settings as well as viewing and printing the failure alarm history. Advanced configuration mode displays the software revision in the **Systolic** and **Diastolic** windows.

How to enter and exit advanced configuration mode

To enter advanced configuration mode:

- With the monitor off, press the **On/Off** button at the same time as pressing and holding the **Menu and -** (minus) buttons.

To exit advanced configuration mode:

- With the monitor on, press the **On/Off** button for less than 5 seconds.

While in advanced configuration mode:

- All parameters are inoperable.
- The **Systolic** window displays **ACF** indicating the monitor is in Advanced configuration mode.
- A failure alarm history can be viewed and printed.

NOTE: Refer to the service manual for instructions for use concerning advanced configuration mode.

Service Mode

Service mode is used to configure and calibrate various components of the monitor's hardware.

NOTE: Refer to the service manual for instructions concerning service mode.

Battery Low Shutdown

Battery low shutdown is entered when the high-priority **BATTERY LOW** alarm has been active for 5 minutes. Refer to the "Alarms" Section for details and errors codes. Refer to the service manual for detailed instructions.

System Failure

System failure occurs when the monitor has a depleted battery, or a hardware or software failure. Refer to the "Alarms" Section for details and errors codes. Refer to the service manual for detailed instructions.

User Modes

The V100 Monitor has four user modes that are available during clinical operating mode: menu, cycle, limit adjustment, and history.

Menu Mode

The menu mode allows you to access and change the three settings associated with the following indicators: **INFLATE PRESSURE (ADULT and NEONATE)**, **ALARM VOLUME**, and **PULSE VOLUME**.

To enter this mode, press the **Menu** button. Each press of the **Menu** button steps you through each of these settings.

After 7 seconds of not pressing the **Menu** button, the menu mode is automatically exited. Otherwise, you can exit the menu mode by cycling through all menu options. Upon exiting menu mode, the main monitoring screen is displayed. Alarm and pulse volume settings are retained after power-off. **INFLATE PRESSURE (ADULT, NEONATE)** is reset to its configured default after power-off.

Inflate Pressure

Procedure

NOTE: This setting is available for two patient types: adult and neonate. The adult setting is applicable to both adult and pediatric determinations.

1. Press the **Menu** button. The **INFLATE PRESSURE** indicator flashes, and—at the same time—the **ADULT** indicator and the value in the **Systolic** window light showing you that the **INFLATE PRESSURE** for **ADULT** setting is ready to be changed.
2. To change the associated value, simply use the **+/-** button to increment or decrement, respectively.
3. Press the **Menu** button again. The **INFLATE PRESSURE** indicator flashes, and—at the same time—the **NEONATE** indicator and the value in the **Systolic** window light showing you that the **INFLATE PRESSURE** for **NEONATE** setting is ready to be changed.
4. To change the associated value, simply use the **+/-** button to increment or decrement, respectively.

Alarm Volume

Procedure

1. Press the **Menu** button. The **ALARM VOLUME** indicator flashes.
2. To change the associated value, simply use the **+/-** button to increment or decrement, respectively.

Pulse Volume

Procedure

1. Press the **Menu** button. The **PULSE VOLUME** indicator flashes.
2. To change the associated value, simply use the **+/-** button to increment or decrement, respectively.

Cycle Mode

The cycle mode allows you to start auto cycle and Stat modes.

1. Press the **Cycle** button. The **AUTO CYCLE** indicator flashes.
2. To change the time increment while the **AUTO CYCLE** indicator flashes, simply use the **+/-** button to increment or decrement, respectively. When you reach the beginning or ending of the list, the negative key-click sounds.

OR

3. While the **AUTO CYCLE** indicator flashes, you can also press the **Cycle** button until you reach the desired time increment.

Refer to the “NIBP” Section for more information.

Limit Adjustment Mode

The limit adjustment mode allows you to change alarm limit settings that are used while monitoring a patient. To enter this mode, press the **Alarms** button. All alarm limit settings return to their default settings after power-off. To change the associated limit, simply use the **+/-** button to increment or decrement, respectively. The range and increment/decrement steps for each derived vital sign that has adjustable limits are described in each parameter section. The step size specified (which cannot be adjusted) tells how much the limit value will change per increment/decrement key press and also dictates how close together a pair of limits can be.

Limit-adjustable vital signs are displayed in the following order:

- **ADULT:**
 - ◆ **Systolic HIGH, LOW**
 - ◆ **Diastolic HIGH, LOW**
- **NEONATE:**
 - ◆ **Systolic HIGH, LOW**
 - ◆ **Diastolic HIGH, LOW**
- **Pulse Rate:**
 - ◆ **HIGH, LOW**
- **SpO₂:**
 - ◆ **HIGH, LOW**

NOTES

- The temperature and MAP (mean arterial pressure) vital signs are not checked against alarm limits.
- Only NIBP limits (Systolic and Diastolic) are adjustable based on the patient type.

History Mode

The history mode allows you to access the stored patient data. When the history mode is active, pressing the +/- buttons displays the next or previous entry in the history list. When you reach the beginning or end of the list, a negative key-click sounds. Pressing the **History** button also allows you to view the previous entry.

NOTE: Refer to the "History" Section for more information.

Sounds

The monitor generates sounds based upon user interaction, parameter events, parameter and system alarms, and **BATTERY LOW** alarms.

Start-up Sound

When the monitor is powered on a start-up sound is generated. This start-up sound consists of 5 separate tones generated in succession. Refer to *Turning on the monitor* in the "Getting Started" Section for more details.

User Interaction Sounds

Positive Key Tone

When pressing a button results in its intended function being performed, one audible tone sounds.

Negative Key Tone

When pressing a button results in its intended function not being performed, three audible tones sound.

Alarm Sounds

The monitor generates high-, medium-, and low-priority alarm sounds, each with a different sound. These sounds repeat with the rate dependent on the priority of the alarm and for as long as the alarm is active and not silenced. When alarms of multiple priorities are active, only the highest-priority alarm sound is audible.

High priority

The high-priority alarm sounds three high-pitched tones followed by two high-pitched tones.

Medium priority

The medium-priority alarm sounds three high-pitched tones.

Low priority

The low-priority alarm sounds one single tone.

Battery Low Shutdown and System Failure Sounds

When the monitor enters either of these modes, it generates a sound that remains on until the monitor either automatically shuts down or is turned off. This sound consists of a high-pitched tone that repeats at a very high rate.

Battery Charger Sounds

The battery charger sounds are generated—whether the monitor is on or off—whenever the external DC charger is connected and disconnected.

Power Sources

The V100 Monitor is designed to operate from an internal lead-acid battery. For replacement rechargeable batteries, please refer to “*Replacing the Battery*” in Appendix C “*Maintenance*” of this manual.

Specifications

Specifications	
Mechanical	
Dimensions	
Height	7.7 in (19.5 cm)
Width	8.6 in (21.9 cm) without temperature 10.0 in (25.4 cm) with temperature
Depth	5.3 in (13.5 cm)
Weight (Including battery)	5.4 lb (2.4 kg)
Mountings	Self-supporting on rubber feet or pole mounted
Portability	Carried by recessed handle
Power requirements	
Power converter universal	P/N: 2018859-001
Protection against electrical shock	Class II
AC input	100 to 250VAC, 12VA
DC output voltage	12VDC at 1A The AC mains power adapter contains a nonresettable and nonreplaceable fuse.
Monitor	
Protection against electrical shock	Internally powered or Class II when powered from specified external power supply.
DC input voltage	12 VDC, supplied from a source conforming to IEC 60601-1.
Fuses	The monitor contains three fuses. The fuses are mounted within the monitor. The fuses protect the low voltage DC input, the battery, and the remote alarm output. The +5 V output on the host port connector is regulated by internal supply.
Battery	Refer to "Battery" Section
Environmental	
Operating temperature	+ 5°C to + 40°C (+ 41°F to + 104°F)
Operating atmospheric pressure	700 hPa to 1060 hPa

Product Overview: Specifications

Specifications	
Storage/transportation	
Storage temperature	- 20°C to + 50°C (- 4°F to + 122°F)
Atmospheric pressure	500 hPa to 1060 hPa
Humidity range	5% to 95% noncondensing
Radio frequency	Complies with IEC Publication 60601-1-2 (2001) Medical Electrical Equipment, Electromagnetic Compatibility Requirements and Tests and CISPR 11 (Group 1, Class B) for radiated and conducted emissions

4 Printer

For your notes

Description

The printer is an optional feature to the V100 Monitor. If your monitor contains a printer, each time a printout is started the following information is printed.

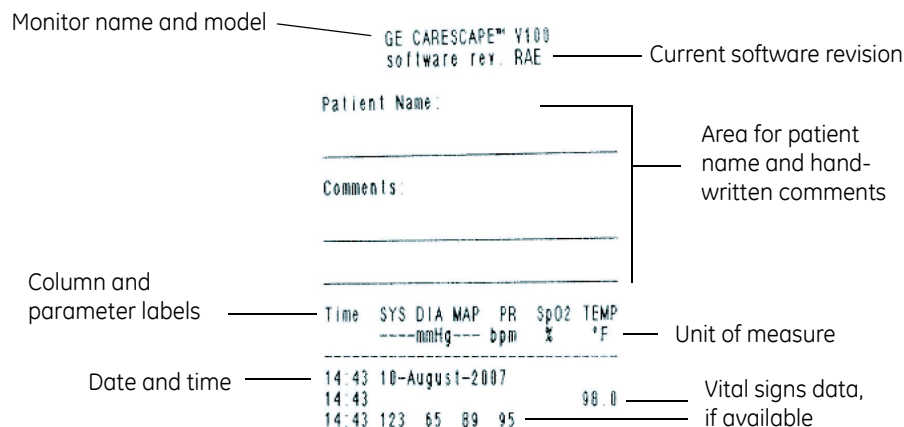

Installing the Paper

Refer to the “Getting Started” Section for instructions.

Print Button

You can print in both clinical and advanced configuration modes. In clinical mode, you can print both currently displayed values and history. In advanced configuration mode you can print a failure alarm history. Refer to the service manual for more information on the use of the **Print** button while in advanced configuration mode.

In clinical mode, pressing the **Print** button prints everything on the screen. Since measurements may have been taken at different times, a time stamp is printed with each parameter. Values are printed in order of the most recent (newest) to the oldest.

By pressing the **Print** button when in history mode, all entries currently stored in the history are printed in order of the most recent to the oldest.

To tear off the printout, use a slight sideways action to pull the paper sharply up across the edge of the door.

Note: If the **Print** button was pressed during the first 10 seconds of SpO₂ monitoring, dashes will appear for SpO₂ and pulse rate readings.

The availability of the printer is determined at the time the printout is started. When the printer is unavailable:

- The **Print** button makes a negative key sound when you press it.
- Printouts of any type are not available and a high-priority **E13 BATTERY LOW** alarm sounds when the **BATTERY LOW** indicator flashes.
- The printer is unavailable if it is out of paper, too hot, or if the monitor is in any of the following modes: cycle, alarm limit adjustment, menu, config, or service.

Printouts

Current (Real Time)

For this printout, the following information may be printed:

- SpO₂ info line:
 - ◆ The time the **Print** button was pressed.
 - ◆ The displayed SpO₂ and pulse rate values are printed under the SpO₂ and pulse rate columns along with the time stamp.
 - ◆ If values are not displayed, "---" is printed.
- PIR info line:
 - ◆ The time the **Print** button was pressed—ONLY if the monitor is configured for TruSignal SpO₂.
 - ◆ The perfusion index measurement is printed when it is valid. Dashes are printed when it is invalid (the sensor is not applied to the patient).
- NIBP info line:
 - ◆ The displayed NIBP values and the time that these values were completed.
 - ◆ The displayed pulse rate values if they were completed at the same time as the displayed NIBP values.
- Temperature info line:
 - ◆ The values of a previous temperature measurement if they are still displayed in the **Temperature** window.
 - ◆ The time that the measurement completed.
- The above lines are printed in the order of most recent to oldest with the exception of the PIR info line, which always follows the SpO₂ info line. If the date changes between entries, a single line containing the date is printed.

Clinical History

All entries currently stored in the clinical history list when the **Print** button is pressed are printed in the order of the most recent (newest) to the oldest. For a value that was violating its high limit when it was stored, an up arrow is printed after the value. For a value that was violating its low limit when it was stored, a down arrow is printed after that value. If the date changes between entries, a single line containing the date is printed.

Failure Alarm History

The monitor must be in advanced configuration mode to print the failure alarm history. When the **Print** button is pressed, all entries in the failure alarm history are printed. They are printed in the order of the most recent to the oldest. Each entry is printed on one line and that line contains, from left to right, the following:

- Time of day as HH:MM, in military time, the failure was detected
- Date the failure was detected as DD-Month-YYYY, where DD is the day, Month is the month spelled out and YYYY is the year
- System error code for the detected failure

Paper Storage

Store thermal paper in a cool, dry place. The printed strip (thermal paper recording) should not be

- Exposed to direct sunlight
- Exposed to temperatures over 100 °F/38 °C or relative humidity over 80%
- Placed in contact with adhesives, adhesive tapes, or plasticizers such as those found in all PVC page protectors

NOTE: When in doubt about long-term storage conditions, store a photocopy of the thermal paper recording.

CAUTIONS

The paper is thermally activated; therefore, do not store it in a hot place as discoloration may result.

Use only replacement paper rolls (P/N 089100 for box of 10) from GE Medical Systems *Information Technologies-Accessories and Supplies*.

Alarms

Refer to the “Alarms” Section for detailed information regarding printer alarms.

Specifications

Specifications	
Printer type	Thermal dot array
Resolution	384 dots/inch horizontal
Paper type	The paper roll used by the printer must be compatible with GE PN 770137.
Languages printed	English, German, French, Italian, Spanish, Portuguese (Brazil and Portugal), Hungarian, Polish, Czech, Finnish, Swedish, Danish, Dutch, Norwegian, and Slovak
Languages not printed (text printed in English only)	Russian, Greek, Korean, and Japanese

5 Alarms

For your notes

Description

The V100 Monitor provides visible and audible indications of patient- and system-related alarm conditions. An alarm can generate an audible indication, visual indication, alarm message code, and electronic record in the history. There are three categories of alarms: patient-related (limit and parameter status alarms), system-related (printer, battery, and memory alarms), and system failures.

All alarm indications are accompanied by an audible signal unless alarm silence is active. A system failure and battery low shutdown generates a high-pitched audible alarm regardless of alarm silence being active.

Adjusting Alarm Limits

Alarms Button

Alarm limits can be adjusted by pressing the **Alarms** button. The first value to adjust is systolic high limit. Subsequent presses of the **Alarms** button take you to the next adjustment in the sequence. Pressing the **+/-** buttons increments/decrements the selected value.

To exit limit adjustment mode after setting alarms, press the **Alarms** button until the main monitoring screen appears. Or, you can let the mode time-out by not touching the limit adjustment button until the main monitoring screen appears. The monitor returns to all default limit settings after power-off; these defaults are adjustable via configuration mode.

Limits for a particular vital sign are displayed in the applicable vital sign's window, with the high limit always being displayed first. Vital sign limits are displayed in the following order: Systolic (HIGH, LOW) for adult/ped patient, Diastolic (HIGH, LOW) for adult/ped patient type, Systolic (HIGH, LOW) for neonate patient type, Diastolic (HIGH, LOW) for neonate patient type, pulse rate and SpO₂ (optional).

NOTES

- ◆ The temperature and MAP vital signs are not checked against alarm limits.
- ◆ Only NIBP limits (diastolic and systolic) are adjustable based on the patient type.

Adjusting the Alarm Volume

You can adjust the alarm volume by pressing the **Menu** button. **ALARM VOLUME** flashes in green with the value in the Diastolic window. You can set the **ALARM VOLUME** range from **1** to **10** (10 being the loudest). The typical range of alarm volume is 60 dB to 75 dB. Changing the volume applies to all alarms.

The positive key tone that sounds when you press the **+/-** buttons relates directly to the user-set alarm volume.

Silencing and Acknowledging an Alarm

Silence Button

To silence a patient-related alarm (limit and parameter status alarms) at anytime, press the **Silence** button. The silence icon (a bell) lights red to indicate that audible alarms have been silenced for 2 minutes.

Some patient- and system-related alarms are acknowledgeable. (Refer to the *Alarms Table* at the back of this section.) For acknowledgeable alarms that are active when the **Silence** button is pressed, any associated audible or visual indication is removed and any associated alarm message code is no longer displayed.

The silence icon has three states:

- Solid red: alarm silence is active.
- Blinking red: alarm silence is not active and at least one alarm condition is active.
- Off: alarm silence is not active and no alarm condition is active.

Alarm Sounds

The monitor produces three different alarm sounds based upon the priority of the alarm: high, medium and low priority.

- The high-priority alarm sounds three high-pitched tones followed by two high-pitched tones.
- The medium-priority alarm sounds three high-pitched tones.
- The low-priority alarm sounds one single tone.

NOTE: When alarms of multiple priorities are active, only the highest-priority alarm sounds.

Alarms and Priorities

For a listing of errors codes refer to the table at the end of this section.

Limit Alarms

The monitor checks each derived vital sign (except MAP and temperature) against user-set limits. A high-limit alarm is generated when that value is greater than its high limit. A low-limit alarm is generated when that value is less than its low limit. All limit alarms are considered high priority.

Parameter	Range	Factory default adult *	Factory default neonate *
Systolic HIGH	35 to 290	200	100
Systolic LOW	30 to 285	80	40
Diastolic HIGH	15 to 220	120	60
Diastolic LOW	10 to 215	30	20
Pulse rate HIGH	30 to 235	150	150
Pulse rate LOW	30 to 235	50	50
SpO ₂ HIGH	71 to 100	100	100
SpO ₂ LOW	70 to 99	90	90
*To change alarm default settings, refer to the "Getting Started" Section.			

When a limit violation occurs, the following happens:

- The derived vital sign that is out of limits and the associated **HIGH** or **LOW** indicator flash.
- The high-priority alarm sound becomes audible unless alarm silence is active.

Parameter Status Alarms

The monitor generates parameter status alarms when unusual patient or sensor conditions are detected. All parameter status alarms are considered high-priority alarms. Refer to the Alarm Message Codes Table in this section.

When a parameter status alarm occurs, the following happens:

- Its code flashes in the associated window.
- The high-priority alarm sound becomes audible unless alarm silence is active.

Printer Alarms

When any of the alarm conditions occur, the alarm code flashes in the **min** window and a high-priority alarm sounds. When a printer alarm condition is active, you can acknowledge and silence the alarm by pressing the **Silence** button. If an **E13 BATTERY LOW** alarm is active, it takes precedence over active printer alarms and **E13** appears in the **min** window.

Memory Alarm

The **E00** MEMORY LOST alarm is generated on power-up when battery backed RAM has been corrupted. When it occurs, all settings are reset to their factory defaults and all entries in clinical history are erased. This alarm is generated as a high-priority alarm.

When detected while powering-up in clinical, configuration, or advanced configuration mode, the status code related to this condition flashes in the **Systolic** window and the appropriate alarm sound becomes audible. While the **E00** MEMORY LOST alarm is active, all parameters remain in their offline state and only the **Silence** button is available.

Battery Alarms

Refer to the “*Battery*” Section for detailed information regarding battery alarms.

Remote Alarm

Remote alarms are an output of the host comm connector. A remote alarm activates when any high- or medium-priority alarms or system failure alarms are active, or if the monitor is powered off.

NOTE: When using remote alarm, the V100 Monitor should be considered the primary alarm source. The secondary alarm is used for secondary purposes only.

System Failure

The system failure mode is activated when there is a hardware or software failure. To view and print a system failure entry, the monitor must be in advanced configuration mode.

- The **Systolic** window displays a failure error code.
- The failure sound is generated for up to 5 minutes.
- To turn the monitor off, press the **On/Off** button for less than 5 seconds.
- After alarming for up to 5 minutes the monitor shuts down completely.

NOTE: Refer to the Service Manual for instructions concerning system failure mode.

Alarms

Alarm message code (if any)	Alarm detected	Cause	Alarm category	Acknowledgeable by pressing Silence?*
NIBP				
	NIBP SYSTOLIC HIGH	Value is greater than the HIGH alarm limit	limit	yes
	NIBP SYSTOLIC LOW	Value is less than the LOW alarm limit	limit	yes
	NIBP DIASTOLIC HIGH	Value is greater than the HIGH alarm limit	limit	yes
	NIBP DIASTOLIC LOW	Value is less than the LOW alarm limit	limit	yes
E89	NIBP NO DETERMINATION	NIBP failed. Reapply cuff	status	yes
E85	NIBP LEVEL TIMEOUT	Motion or irregular pulse. Reduce motion	status	yes
E84	NIBP TOTAL TIMEOUT	Motion or irregular pulse. Reduce motion	status	yes
E83	NIBP PUMP TIMEOUT	Pressure leak. Check or replace hose or cuff	status	yes
E82	NIBP EXCESS AIR IN CUFF	Excess amount of air in the cuff. Allow cuff to deflate	status	yes
E80	NIBP OVERPRESSURE	Excess cuff pressure. Check for hose blockage	status	yes
SpO₂				
	SpO ₂ HIGH	Value is greater than the HIGH alarm limit	limit	no
	SpO ₂ LOW	Value is less than the LOW alarm limit	limit	no
E20	SpO ₂ SENSOR DISCONNECTED	Sensor disconnected	status	yes
E21	SpO ₂ REPLACE SENSOR	Sensor broken or wrong type. Replace	status	yes
---	SpO ₂ SENSOR OFF FINGER	Sensor off finger	status	yes
E25	SpO ₂ LOST PULSE	Lost pulse	status	yes
Temperature				
E61	TEMP PROBE BROKEN	Probe broken. Replace	status	no
E63	TEMP DISCONNECTED	Disconnected or wrong probe	status	yes
E66	TEMP PROBE TOO HOT	Probe too hot	status	yes

Alarms: Factory Defaults

Alarm message code (if any)	Alarm detected	Cause	Alarm category	Acknowledgeable by pressing Silence?*
Pulse rate				
	PULSE RATE HIGH	Value is greater than the HIGH alarm limit	limit	no-SpO ₂ , yes-NIBP
	PULSE RATE LOW	Value is less than the LOW alarm limit	limit	no-SpO ₂ , yes-NIBP
Printer				
E10	PRINTER NO PAPER	Printer no paper	status	yes
E11	PRINTER TOO HOT	Printer too hot	status	yes
Battery				
E13	BATTERY LOW	Battery too low	status	yes
	BATTERY LOW	Battery is running low and should be plugged in	status	yes
E00	MEMORY LOST	Memory loss	status	yes
System failure				
891-999	SYSTEM FAILURE	Internal system failure. Refer to the service manual or call Technical Support for definitions and instructions		no
*Acknowledging an alarm by pressing the Silence button, cancels the alarm.				

Factory Defaults

Alarm volume	5
--------------	---

6 History

For your notes

Description

NOTE: Age in this section refers to when and how long ago the vital signs were taken.

The history mode allows you to access stored patient data in clinical mode and a failure alarm history in advanced configuration mode. The history mode is especially useful when doing hospital rounds: if the patient's temperature and SpO₂ measurements are taken while an NIBP determination is in progress, then upon completion of the determination, pressing the **History** button once shows all vital signs on the same screen for that patient.

The following information refers to operation in clinical mode. The V100 Monitor can hold up to 40 stored entries in history. It displays the most recent entries first. When full, the oldest entry is removed so the most recent entry can be stored. Additionally, entries are automatically removed when they become older than 24 hours.

The age of each entry is maintained and displayed in the **min** window with a minus sign (-) in front of it when other data stored for that entry is displayed. For entries that are greater than 59 minutes old, the age is displayed as HH:MM (hour:min). For entries that are less than or equal to 59 minutes old, the age is displayed in total minutes.

When viewing entries in history that are out of limits, the corresponding **HIGH** or **LOW** indicator appears in red.

An entry is stored in history at the completion of an NIBP determination and at the completion of a successful predictive temperature measurement. At the end of an NIBP determination, systolic, diastolic, MAP, pulse rate, SpO₂, and temperature (if measurement is completed while the NIBP determination was in progress) values are stored. However, when continuously monitoring SpO₂, values are not stored periodically but only when an NIBP determination completes. At the end of a temperature determination that completes while an NIBP determination is not in progress, only the temperature value is stored.

To obtain a full set of vitals stored in the same history entry:

1. Place the SpO₂ sensor on patient's finger and place the cuff on the other limb.
2. Start the NIBP determination.
3. Take the temperature measurement while the NIBP determination is in progress.
4. Upon completion of the NIBP determination, remove the cuff and sensor.
5. Press the **History** button to view all vitals.

Buttons Associated with History

To activate the history mode, press the **History** button. The **HISTORY** indicator flashes green while this mode is active. With each press of the **History** button, the patient data stored with the next oldest entry is displayed. Entries are displayed from the most recent to the oldest. For example, the most recent entry could have an age of -0 minutes and the oldest entry could have an age of -23:59.

You can also activate the history mode by pushing the **History** button and then using the **+/-** buttons to scroll through the stored entries. Pressing the **History** button again exits history mode. Upon exiting history mode, the main monitoring screen is displayed.

After 15 seconds of not pressing the **History** or the **+/-** button, the history mode is automatically exited. Otherwise, you can exit the history mode by pressing the **History** button one more time after viewing the oldest entry. Upon exiting history mode, the main monitoring screen is displayed.

Erasing Stored History

To erase stored patient data when a static printout is not in progress, press and hold the **History** button for a minimum of 2 seconds. All entries that were stored in history as well as any patient data displayed on the monitor that relates to the previous determination or the previous temperature measurement are erased. Pressing and holding the **History** button for 2 seconds also causes the target pressure to return to the current value in the **INFLATE PRESSURE** setting.

Windows Associated with History

Each window on the monitor can be active during history mode. When the **History** button is pressed the patient data stored for each entry is displayed in the applicable windows. Patient data is displayed from most recent to oldest, indicated by the age in the **min** window.

Indicators Associated with History

The **HISTORY** indicator is used to show the state of the history mode. When history mode is active, the **HISTORY** indicator flashes green.

7 NIBP

For your notes

Description

NOTE: Age in this section refers to how long ago the vital signs were taken.

The NIBP parameter in the V100 Monitor is available with two types of NIBP technologies: one calibrated to intra-arterial pressure (DINAMAP SuperSTAT or Classic) and one calibrated to the auscultatory method (specific technologies are available in select markets).

When the monitor initially enters configuration mode the type of NIBP technology appears in the **min** window: **StAt** for SuperSTAT NIBP, **AUSC** for Auscultatory NIBP, and **CLAS** for Classic NIBP.

NOTE: Refer to the “*Product Overview*” Section for instructions on accessing configuration mode.

Refer to Appendix D “*Principles of Noninvasive Blood Pressure Determination*” for specific information regarding these technologies. Most user interface options, instructions for use, and alarms will be the same for all technologies. The NIBP parameter is included in all models. Blood pressure is monitored noninvasively in the V100 Monitor by oscillometric method.

NOTE: For neonatal populations, the reference is always the intra-arterial pressure monitoring method.

The V100 Monitor has three NIBP modes: 1. manual, 2. auto cycle, and 3. Stat. The mode is selected by the user. The actual NIBP determination is automated and, once it is complete, the values for systolic pressure, diastolic pressure, mean arterial pressure, and pulse rate (if SpO₂ is not active) are shown in their respective windows.

Before each NIBP determination, the monitor performs a test to ensure that the cuff pressure is below a specified level. The determination is delayed until this condition is met. The monitor senses the type of hose being used and automatically uses adult/pediatric monitoring parameters or neonate monitoring parameters, as appropriate.

Audible and visible alarms occur when any of the values for systolic pressure, diastolic pressure, or pulse rate (if sourced by NIBP) are outside their selected high or low limits.

NOTE: When the **BATTERY LOW** alarm is active as a high-priority alarm, any attempts to start an NIBP determination results in an **E13 BATTERY LOW** alarm. At anytime during monitoring, if an NIBP determination is started and cannot be completed due to a low or bad battery, the monitor issues an **E13 BATTERY LOW** alarm. Because this particular event can be indicative of a bad battery, this alarm event is logged into the failure alarm history.

Instructions for cleaning and disinfecting NIBP cuffs are in Appendix C “*Maintenance.*”

What is the Difference Between Intra-Arterial and Auscultatory Methods?

Oscillometric Method

The oscillometric method of determining NIBP is accomplished by a sensitive transducer which measures cuff pressure and pressure oscillations within the cuff. These signals are analyzed by the algorithm that uses one of the references (intra-arterial or auscultatory) to display the NIBP values.

Intra-Arterial Reference

The intra-arterial reference algorithm was developed based on blood pressure values obtained with an intra-arterial catheter (central aortic).

Auscultatory Reference

The auscultatory reference algorithm was developed based on blood pressure values obtained with a sphygmomanometer, a stethoscope, and listening to the Korotkoff sounds.

NOTE: NIBP values in the V100 are based on the oscillometric method of noninvasive blood pressure measurement taken with a cuff on the arm of adults/pediatrics (SuperSTAT and Classic technologies), a cuff on the calf of neonates (SuperSTAT technology), and a cuff on the arm of neonates (Classic technology). The values correspond to comparisons with intra-arterial values within ANSI/AAMI SP10 Standards for accuracy (a mean difference of ± 5 mmHg, and a standard deviation of ≤ 8 mmHg).

WARNINGS

Connect cuffs and inflation systems only to systems designed for non-invasive blood pressure monitoring. Devices with luers and locking luer connectors may be inadvertently connected to intravascular fluid systems that may allow air to be pumped into a blood vessel.

The V100 Monitor will not measure blood pressure effectively on patients who are experiencing seizures or tremors.

Arrhythmias will increase the time required by the NIBP parameter to determine a blood pressure and may extend the time beyond the maximum allowed time for the parameter (120 seconds for adult/pediatric and 85 seconds for neonate).

Devices that exert pressure on tissue have been associated with purpura, skin avulsion, compartmental syndrome, ischemia and/or neuropathy. To minimize these potential problems, especially when monitoring at frequent intervals or over extended periods of time, make sure the cuff is applied appropriately and examine the cuff site and the limb distal to the cuff regularly for signs of impeded blood flow.

Do not apply external pressure against cuff while monitoring. Doing so may cause inaccurate blood pressure values.

WARNINGS

The values displayed on the monitor could be up to 30 minutes old in manual mode and 120 minutes old in auto mode. If the patient's condition has changed between one determination and the next, the monitor will not detect the change until the next determination is taken.

Use care when placing cuff on extremity used to monitor other patient parameters.

The V100 Monitor is designed for use only with GE CRITIKON BP dual-tube cuffs.

Use only accessories approved for use with CARESCAPE Monitors. Failure to use recommended accessories may result in inaccurate readings.

Blood pressure cuffs should be removed from the patient when the monitor is powered off. If the extremity remains cuffed under these conditions or if the interval between blood pressure determinations is prolonged, the patient's limb should be observed frequently and the cuff placement site should be rotated as needed.

CAUTIONS

Accuracy of NIBP measurement depends on using a cuff of the proper size. It is essential to measure the circumference of the limb and to select the proper size cuff. In addition, the air hoses are color-coded according to patient population. The gray 12- or 24-foot hose (3.66 m or 7.3 m) is required on patients who require cuff sizes from infant through thigh cuffs. The light blue 12-foot hose (3.66 m) is required for the neonatal cuff sizes #1 through #5.

Do not use an infant cuff with an auscultatory reference. The neonatal #5 cuff and neonatal hose may be used on patients with an arm circumference of 8 - 15 cm.

If it becomes necessary to move the cuff to another limb, make sure the appropriate size cuff is used.

The pulse rate derived from an NIBP determination may differ from the heart rate derived from an EKG waveform because the V100 Monitor measures actual peripheral pulses, not electrical signals or contractions from the heart. Differences may occur because electrical signals at the heart occasionally fail to produce a peripheral pulse or the patient may have poor peripheral perfusion. Also, if a patient's beat-to-beat pulse amplitude varies significantly (e.g., because of pulsus alternans, atrial fibrillation, or the use of a rapid-cycling artificial ventilator), blood pressure and pulse rate readings can be erratic, and an alternate measuring method should be used for confirmation.

NOTES

- A patient's vital signs may vary dramatically during the use of cardiovascular agents such as those that raise or lower blood pressure or those that increase or decrease heart rate.
- Several conditions may cause the NIBP parameter to calculate and display only the mean arterial pressure (MAP) without systolic and diastolic readings. These conditions include very low systolic and amplitude fluctuations, so an accurate calculation for these values can't be made (e.g., patient in shock); too small of a difference between systolic and MAP calculations in relationship to the difference between diastolic and MAP; or a leak has occurred in the V100 Monitor. If only the MAP value is displayed, an alarm message code is displayed in the systolic window, while the **Diastolic** window remains blank.
- This equipment is suitable for use in the presence of electrosurgery.

Buttons Associated with NIBP

The buttons associated with NIBP are **Inflate/Stop** and **Cycle**.

Inflate/Stop Button

The **Inflate/Stop** button starts and stops NIBP determinations. When a determination is in progress, pressing this button stops the determination. While in Stat mode, pressing this button cancels Stat mode, as well a determination if in progress. When in auto cycle mode, pressing this button starts a determination or cancels a determination if in progress; it does not change the mode.

While an **E80** NIBP OVERPRESSURE alarm is active, all presses of this button are ignored and you will hear the negative key tone. Pressing this button while the **BATTERY LOW** alarm is active as a high-priority alarm causes an **E13 BATTERY LOW** alarm to sound and you will hear the negative key tone.

Cycle Button

The **Cycle** button initiates the cycle mode, which is where you can choose Stat or an auto cycle time. Successive presses of the **Cycle** button show selections of: **Stat, 1, 2, 3, 4, 5, 10, 15, 20, 30, 60, 90, 120** (minutes), and - - (two dashes). Choose **Stat** to start Stat mode. Choose **1-120** to select the desired cycle time and start auto cycle mode. When you reach the desired setting, do not press the **Cycle** button again. After 2 seconds the cycle mode is deactivated and the main monitoring screen is displayed. Choose the two dashes to cancel auto cycle mode.

The **+/-** buttons can be used to scroll forwards or backwards through the cycle selections while the **AUTO CYCLE** indicator is flashing.

Pressing this button while the **E80** NIBP OVERPRESSURE alarm is active results in the sounding of the negative key tone and no further action.

Pressing this button key while the **BATTERY LOW** alarm is active as a high-priority alarm results in the generation of the **E13 BATTERY LOW** alarm and the sounding of the negative key tone.

Windows Associated with NIBP

The windows associated with NIBP are **Systolic, Diastolic, MAP/Cuff, Pulse Rate, and min**. The **Systolic, Diastolic, MAP/Cuff, and Pulse Rate** (if SpO₂ is not active) windows are automatically cleared when a new NIBP determination is started. In manual mode, the displayed information is also cleared when it becomes older than 30 minutes.

The **Systolic** and **Diastolic** windows display values after a determination has completed successfully. While in Stat mode, the **Systolic** window flashes the early systolic value if it is available.

The **MAP/Cuff** window displays the derived mean arterial pressure (MAP) following the completion of a successful determination. During any type of NIBP determination, the pressure inside the cuff appears in this window.

The **Pulse Rate** window displays the NIBP-derived pulse rate when SpO₂ is inactive.

The **min** window displays the NIBP mode of operation and the age of the previous NIBP determination. When both types of information are present, they flash alternately in this window. When in manual mode, two dashes (- -) are displayed. When in auto cycle mode, the chosen Cycle time is displayed (e.g., **15**). When in Stat mode, **Stat** is displayed. When displayed, the age of the previous NIBP determination is preceded by a minus sign (e.g., **- 5** for a determination that was taken 5 minutes ago).

Indicators Associated with NIBP

The indicators associated with NIBP are Systolic **HIGH** and **LOW**, Diastolic **HIGH** and **LOW**, **AUTO CYCLE**, **INFLATE PRESSURE**, **ADULT**, **NEONATE**, and **HISTORY**.

The **AUTO CYCLE** indicator appears solid green when auto mode is on. It flashes green when changes are being made to the current NIBP mode (e.g., cycle mode is active). The **ADULT** indicator appears solid green while systolic and diastolic limits and **INFLATE PRESSURE** for adult/pediatric are being adjusted. The **NEONATE** indicator appears solid green while limits for systolic and diastolic or **INFLATE PRESSURE** for neonate are being adjusted. The **HISTORY** indicator appears solid green when the age of the previous NIBP determination is displayed in the **min** window.

NOTE: The **ADULT** indicator encompasses both adult and pediatric patients.

NIBP Modes of Operation

The V100 Monitor has three NIBP modes:

1. Manual
2. Auto cycle
3. Stat

The mode is selected by the user. NIBP determinations are automated and, upon completion, the values for systolic pressure, diastolic pressure, mean arterial pressure, and pulse rate (if SpO₂ is not active) are shown in their respective windows.

Manual NIBP Determinations

Manual mode is always the NIBP mode of operation upon power-up. A normal, uninterrupted Manual determination takes about 40 seconds. Following a determination, the cuff pressure must drop below 5 mmHg (neonate) or 15 mmHg (adult) before another determination can be started.

Manual NIBP determinations are started by pressing the **Inflate/Stop** button. To stop a Manual NIBP determination press the **Inflate/Stop** button. The values displayed in the **Systolic, Diastolic, MAP, and Pulse Rate** (if SpO₂ is not active) windows are cleared after 30 minutes have lapsed.

Auto Cycle Determinations

Auto cycle mode automatically starts determinations at user-defined intervals. In the auto cycle mode, the pressure must be below 5 mmHg (neonate) or 15 mmHg (adult) for at least 30 seconds before the next auto determination will be started.

Auto cycle mode is started by selecting the **Cycle** button. When in auto cycle mode, the **AUTO CYCLE** indicator appears solid green. Manual determinations can be taken while in auto cycle mode without affecting when the next auto determination is to start. You can also change the time interval while in auto cycle mode.

Once the **Cycle** button is pressed, the first auto cycle determination is started, and the time between determinations appears in the **min** window. Successive presses of the **Cycle** button show selections of: **Stat, 1, 2, 3, 4, 5, 10, 15, 20, 30, 60, 90, 120** (minutes), and **--** (two dashes). When you reach the desired time interval, do not press the **Cycle** button again; after 2 seconds, the chosen time interval is retained and remains in the **min** window and the main monitoring screen is displayed.

Pressing the **Cycle** button when in auto cycle mode activates cycle mode again with two dashes (**--**) appearing in the **min** window. If you press the **Cycle** button immediately after the first press, the next time interval appears in the **min** window. If you do not press the **Cycle** button immediately after the first press,

cycle mode is deactivated. Press the **Inflate/Stop** button to stop the determination in progress without canceling the auto cycle mode. Choose the two dashes (- -) to cancel auto cycle mode.

If an auto cycle determination results in a limit alarm, a repeat determination is taken to verify the alarm. Only the first determination in a series of limit alarms will be followed by a repeat determination.

Whenever an Auto Cycle determination results in an **E89** NIBP NO DETERMINATION alarm, up to nine more repeat determinations are attempted until valid values are achieved. If at any time during this repeat cycle, the **E89** NIBP NO DETERMINATION alarm is silenced by pressing the **Silence** button or the **Inflate/Stop** button, additional determinations are not attempted. If the repeat cycle completes all nine repeat determinations without reaching a valid value, the monitor returns to normal auto cycle mode. However, an auto cycle mode determination must complete successfully before a repeat cycle will follow a future auto cycle mode determination that results in an **E89** NIBP NO DETERMINATION alarm.

Stat NIBP Determinations

Stat mode allows you to take as many determinations as possible within a 5-minute time period. The monitor will begin another determination once the pressure is below 5 mmHg for 8 seconds (neonates) or 15 mmHg for 4 seconds (adult/pediatric), unless the 5-minute period has ended or Stat mode has been canceled.

NOTE: NIBP and NIBP-derived pulse rate alarm limits are disabled while in Stat mode.

Stat NIBP determinations are started by selecting the **Cycle** button. Once the **Cycle** button is pressed, choose **Stat**. The monitor automatically begins a 5-minute period of Stat determinations.

NOTE: If the monitor was previously in auto mode, the first Stat NIBP determination begins after 2 seconds.

After the first Stat determination, subsequent determinations display an early systolic value that displays in the **Systolic** window. If Stat mode is started when a determination is already in progress, that determination becomes the first in the series of Stat determinations. At the end of Stat mode, the NIBP mode prior to entering Stat mode is resumed. To cancel Stat mode, press the **Inflate/Stop** button.

User Settings

Mode Settings

There is one mode setting associated with this parameter: cycle. The cycle mode is started by pressing the **Cycle** button. While the cycle mode is active, cycle selections are displayed in the **min** window. Cycle selections appear: **Stat, 1, 2, 3, 4, 5, 10, 15, 20, 30, 60, 90, 120, - -**. Refer to "Buttons Associated with NIBP" in this section.

Limit Settings

There are two limit settings associated with this parameter: **HIGH** and **LOW**. Both limit settings are available for **Systolic** and **Diastolic** windows, as well as **Pulse Rate** (refer to the “Pulse Rate” Section). The settings appear in increments of 5 mmHg.

Systolic and Diastolic limits are adjustable for adult/ped and neonate patient types. The **ADULT** indicator is solid green while Systolic and Diastolic limits for adult/pediatric are being adjusted. The **NEONATE** indicator is solid green while Systolic and Diastolic limits for neonate are being adjusted. Upon completion of a determination, the monitor evaluates the results of that determination against the appropriate set of limits based upon the type of NIBP hose that is connected.

Systolic	Range (in mmHg)	
Patient type	HIGH	LOW
Adult/ped	35 to 290	30 to 285
Neonate	35 to 140	30 to 135

Diastolic	Range (in mmHg)	
Patient type	HIGH	LOW
Adult/ped	15 to 220	10 to 215
Neonate	15 to 110	10 to 105

Menu Settings

The **INFLATE PRESSURE** menu setting is associated with the NIBP parameter. This option lets you adjust the target pressure that the monitor initially pumps to for the next determination.

Window	Systolic
Type	Patient-related
Range: Adult/ped Neonate	100 to 250 mmHg for adult/ped for Classic, Auscultatory, and SuperSTAT 70 to 140 SuperSTAT 100 to 140 for Classic
Steps of	5 mmHg

The **INFLATE PRESSURE** option is adjustable for adult/pediatric and neonate patient types, respectively. For all NIBP modes, the NIBP parameter detects the type of hose being used and automatically uses adult/pediatric or neonate monitoring settings, as appropriate.

Changing this setting for either patient type cancels a determination that is in progress and clears previously derived Systolic, Diastolic and MAP values in their associated windows.

The appropriate target inflation pressure for the next determination is used when any of the following are true:

- A current valid MAP value is not displayed.
- In manual mode and the last determination is greater than 2 minutes old.
- Any determination attempted that the detected hose type does not match that of the previous determination.

Sounds Associated with NIBP

There is one tone associated with this parameter. The tone sounds at the completion of any NIBP determination.

Procedures

1. Connect the end of the air hose which has quick-release clips to the NIBP connector on the front of the monitor. Make sure that the hose is not kinked or compressed.

NOTE: To disconnect the hose from the monitor, squeeze the quick-release clips together and pull the plug from the NIBP connector.

2. Choose the appropriate blood pressure measurement site. In adult/ped patients, the upper arm is preferred for convenience and because normative values are generally based on this site. When factors prohibit use of the upper arm, the clinician must plan patient care accordingly, taking into account the patient's cardiovascular status and the effect of an alternative site on blood pressure values, proper cuff size, and comfort. The figure shows the recommended sites for placing cuffs.

WARNING

Do not place the cuff on a limb being used for intravenous infusion or any area where circulation is compromised or has the potential to be compromised.

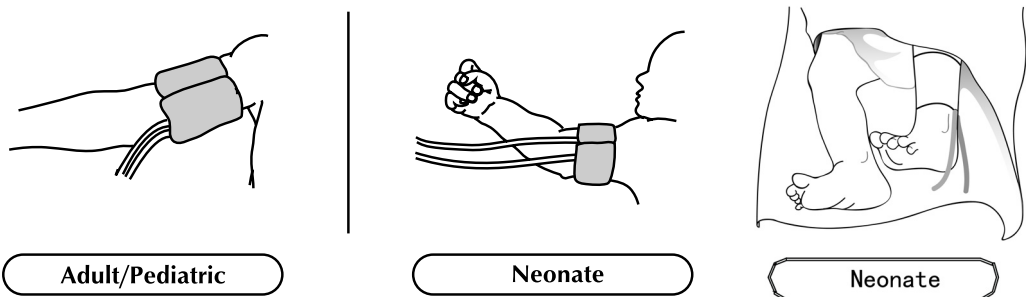

3. If patient is standing, sitting, or inclined, ensure that cuffed limb is supported to maintain cuff at level of patient's heart. If cuff is not at heart level, the difference in systolic and diastolic values due to hydrostatic effect must be considered.

Add 1.80 mmHg to values for every inch (2.54 cm) above heart level. Subtract 1.80 mmHg from values for every inch (2.54 cm) below heart level.

4. Select appropriate cuff size. Measure patient's limb and select appropriately sized cuff according to size marked on cuff or cuff packaging. When cuff sizes overlap for a specified circumference, choose the larger size cuff.

CAUTIONS

Accuracy depends on use of proper size cuff.

NOTE: Use only GE CRITIKON BP cuffs. The size, shape, and bladder characteristics can affect the performance of the instrument. Inaccurate readings may occur unless GE CRITIKON BP cuffs are used.

5. Inspect cuff for damage. Replace cuff when aging, tearing, or weak closure is apparent. Do not inflate cuff when unwrapped.

CAUTION

Do not use cuff if structural integrity is suspect.

6. Connect the cuff to the air hose.
7. Inspect patient's limb prior to application.

CAUTION

Do not apply cuff to areas where skin is not intact or tissue is injured.

8. Palpate artery and place cuff so that patient's artery is aligned with cuff arrow marked "artery."
9. Squeeze all air from cuff and confirm that the connection is secure and unoccluded and that tubing is not kinked.
10. Wrap cuff snugly around the patient's limb. Cuff index line must fall within the range markings. Ensure that hook and loop closures are properly engaged so that pressure is evenly distributed throughout cuff. If upper arm is used, place cuff as far proximally as possible.
11. Proper cuff wrapping should be snug, but should still allow space for a finger between patient and cuff. Cuff should not be so tight as to prevent venous return between determinations.

WARNING

Using a cuff that is too tight will cause venous congestion and discoloration of the limb, but using a cuff that is too loose may result in no readings and/or inaccurate readings.

12. Proceed with monitoring in the manual, auto cycle, or Stat mode.

What to do When Taking NIBPs on Different Patients

To ensure the previous patient's NIBP will not be used for adaptive target inflation pressure when taking an NIBP on a new patient, you can 1.) clear the history by holding the history key for more than 2 seconds, or 2.) if in manual mode, wait for more than 2 minutes since the last determination was taken on the previous patient.

In manual mode, the monitor will not use the displayed NIBP values for adaptive target inflation pressure if it has been more than 2 minutes since the end of the previous determination. In manual mode, the NIBP values are displayed for a maximum of 30 minutes. In auto mode, the displayed NIBP values are used for adaptive target inflation pressure independent of the length of time the values are displayed.

Alarms

Upon completion of a determination that results in Systolic and Diastolic values, these values are checked against the appropriate set of patient type limits based upon the hose type detected. During Stat mode determinations, Systolic and Diastolic values are not checked against their limits. When the limit alarms are active, they can be silenced by pressing the **Silence** or **Alarms** button.

The **Systolic** window is used for NIBP status alarms. When active, the status alarms, with the exception of **E80** NIBP OVERPRESSURE, are acknowledged and silenced when a new determination is attempted. All NIBP alarms can be acknowledged and silenced by pressing the **Silence** button.

Specifications

Specifications	
Cuff pressure range (Normal operating range)	0 to 290 mmHg (adult/ped) 0 to 145 mmHg (neonate)
Blood pressure accuracy (Classic and Auscultatory)	Meets ANSI/AAMI standard SP-10:1992 (mean error \leq 5 mmHg, standard deviation \leq 8 mmHg)
Blood pressure accuracy (SuperSTAT)	Meets ANSI/AAMI standard SP-10:2002 (mean error \leq 5 mmHg, standard deviation \leq 8 mmHg)
Maximum determination	120 s (adult/ped) 85 s (neonate)
Overpressure cutoff	300 to 330 mmHg (adult/ped) 150 to 165 mmHg (neonate)
BP range (Classic and Auscultatory)	
Systolic	30 to 245 mmHg (adult/ped) 40 to 140 mmHg (neonate)
MAP	15 to 215 mmHg (adult/ped) 30 to 115 mmHg (neonate)
Diastolic	10 to 195 mmHg (adult/ped) 20 to 100 mmHg (neonate)
BP range (SuperSTAT)	
Systolic	30 to 290 mmHg (adult/ped) 30 to 140 mmHg (neonate)
MAP	20 to 260 mmHg (adult/ped) 20 to 125 mmHg (neonate)
Diastolic	10 to 220 mmHg (adult/ped) 10 to 110 mmHg (neonate)
Pulse rate range (Classic and Auscultatory)	30 to 200 beats/min (adult/ped) 30 to 220 beats/min (neonate)
Pulse rate range (SuperSTAT)	30 to 240 beats/min (adult/ped) 30 to 240 beats/min (neonate)
Pulse rate accuracy	\pm 3.5% or 3 bpm
<p>NOTE: All CARESCAPE V100 Monitor regulatory and accuracy studies have been performed using GE CRITIKON BP cuffs. Use only GE CRITIKON BP cuffs. The size, shape, and bladder characteristics can affect the performance of the instrument. Inaccurate readings may occur unless GE CRITIKON BP cuffs are used.</p>	

Factory Defaults

	Adult/ped	Neonate	Non-patient Specific
Systolic (mmHg)			
HIGH	200	100	
LOW	80	40	
Diastolic (mmHg)			
HIGH	120	60	
LOW	30	20	
Inflation pressure (for Auscultatory)	160	100	
Inflation pressure (for SuperSTAT)	135	100	
Inflation pressure (for Classic)	160	110	
Cycle button default			15 min

GE Medical Systems *Information Technologies* Patents

5,170,795; 5,704,362; 5,518,870; 5,579,776; 6,358,213; 6,746,403; 6,893,403; 6,902,531; 7,070,566; 7,074,192; 7,186,218; 7,198,604 and international equivalents. US patents pending.

8 Ohmeda TruSignal SpO₂

For your notes

Description



The SpO₂ parameter in the V100 Monitor is available in three different leading technologies: Ohmeda TruSignal, Nellcor and Masimo SET. Please refer to the front of your monitor to see which SpO₂ technology your monitor contains. If your monitor contains this parameter, the SpO₂ technology logo will be on the front fascia of the monitor. ***This section refers to Ohmeda TruSignal SpO₂ technology.***

TruSignal Enhanced SpO₂

TruSignal Enhanced SpO₂ offers improved performance, especially during challenging conditions of clinical motion and low perfusion. With ultra-low-noise technology, TruSignal selects the appropriate clinically developed algorithm to compensate for weak or motion-induced signals and generate reliable saturation readings.

The parameter automatically switches on when a sensor is connected to the monitor.

Pulse rate derived from SpO₂ appears in the **Pulse Rate** window and updates continuously. A tone sounds at a rate corresponding to the pulse rate and at a pitch corresponding to the SpO₂ saturation level. The pitch is highest at 100% oxygen saturation, and it continuously decreases as the saturation level falls. The monitor displays a pulse amplitude bar. The pulse amplitude bar graph is proportional to the arterial blood flow.

Audible and visible alarms occur when SpO₂ levels are outside the alarm limits. When a parameter status alarm occurs, an alarm message code appears in the **SpO₂** window.

NOTE: Limit alarms, printing, and trending are not available for the first 10 seconds of SpO₂ monitoring.

PIr pulsatile value

The perfusion index measurement—the PIr pulsatile value—is a quick and easy-to-use clinical tool that provides a dynamic numeric reflection of perfusion at the sensor site. PIr is a relative value that varies from patient to patient.

The PIr pulsatile value indicates the strength of the pulse signal at the sensor site—the higher the PIr value, the stronger the pulse signal. A strong pulse signal increases the validity of SpO₂ and pulse rate data. Clinicians can use the PIr value to compare the strength of the pulse signal at different sites on a patient in order to locate the best site for the sensor—the site with the strongest pulse signal.

TruSignal® is a trademark of GE Healthcare Finland Oy

The perfusion index is only available on a current printout and when the sensor is in place; it does not appear on the monitor screen. On the PIR info line, a row is printed that contains the time the **Print** button was pressed followed by the current perfusion index measurement when it is valid.

WARNINGS

Do not place SpO₂ sensor on patient during magnetic resonance imaging (MRI). Adverse reactions include potential burns to patients as a result of contact with attachments heated by the MRI radio frequency pulse, potential degradation of the magnetic resonance image, and potential reduced accuracy of SpO₂ measurements. Always remove oximetry devices and attachments from the MRI environment before scanning a patient.

The use of cardio-green and other intravascular dyes at certain concentrations may affect the accuracy of the SpO₂ measurement.

As with all medical equipment, carefully route patient cabling to reduce the possibility of patient entanglement or strangulation.

A functional tester cannot be used to assess the accuracy of a pulse oximeter probe or a pulse oximeter monitor.

The SpO₂ function is calibrated to read functional arterial oxygen saturation. Significant levels of dysfunctional hemoglobins such as carboxyhemoglobin or methemoglobin may affect the accuracy of the SpO₂ measurement.

Pulse oximetry readings and pulse signals can be affected by certain environmental conditions, sensor application errors, and certain patient conditions. See the appropriate sections of this manual for specific safety information.

The use of accessories, transducers, and cables other than those specified may result in increased emission and/or decreased immunity and inaccurate readings of the monitor.

CAUTION

As with any clip-on sensor, pressure is exerted. The clinician should be cautious in using a clip-on sensor on patients with compromised circulation (e.g., because of peripheral vascular disease or vasoconstricting medications).

CAUTIONS

Do not perform any testing or maintenance on a sensor while it is being used to monitor a patient. Bright light sources (e.g., infrared heat lamps, bilirubin lights, direct sunlight, operating room lights) may interfere with the performance of the SpO₂ function. To prevent such interference, cover the sensor with opaque material.

NOTES

- A patient's vital signs may vary dramatically during the use of cardiovascular agents such as those that raise or lower blood pressure or those that increase or decrease pulse rate.
- The V100 Monitor that is labeled with TruSignal Technology is compatible only with the TruSignal and OxiTip interconnect cables and sensors.
- Software development, software validation, and Risk and Hazard Analysis has been performed to a registered quality system.
- User or patient-applied parts are latex-free.

Configuration Settings Associated with SpO₂

There is one configuration setting associated with this parameter: line frequency mode (*LF*).

Line frequency mode (*LF*) allows the user to specify the line power frequency of your local AC power source for the best low perfusion performance. Choose **50** Hz filter or **60** Hz filter. The default value is 60 Hz.

CAUTIONS

The LF mode must be set according to each country's electrical power utilities implementation. The LF mode must be checked and reset any time the monitor is set to or reverts to factory default settings.

If the LF mode is set incorrectly, the susceptibility to ambient light is increased and low perfusion performance may be effected resulting in inaccurate readings.

Buttons Associated with SpO₂

There are no buttons associated with this parameter.

Windows Associated with SpO₂

There is one window associated with this parameter: **SpO₂**. While in offline mode, nothing is displayed in the **SpO₂** window. When in ready mode and the parameter senses that a sensor is connected, a single dash (-) appears in this window. When it is in operate mode and the parameter is reporting a valid data, the derived SpO₂ value appears in this window and updates continuously. The values are displayed in %.

NOTE: If SpO₂ is the source for pulse rate, the **Pulse Rate** window is associated with this parameter. Refer to the “*Pulse Rate*” Section for more information.

Indicators Associated with SpO₂

There is one indicator associated with this parameter: the pulse amplitude indicator bar. The red LED bar flashes to indicate that pulse rate measurements are being derived from SpO₂ signals and the height of the bar is proportional to the arterial blood flow.

User Settings

Limit settings

There are two limit settings associated with this parameter: **HIGH** and **LOW**. The range for **HIGH** is 71 to 100%. The range for **LOW** is 70 to 99%. The settings appear in increments of 1%.

Menu Settings

The **PULSE VOLUME** menu setting is associated with the SpO₂ parameter. This option lets you adjust the volume of the tone that sounds after each detected pulse. It can be adjusted from **0** to **10** (10 being the loudest). If you set the volume to zero, no tone will sound.

Sounds Associated with SpO₂

An audible tone is provided by the monitor for each pulse detected by the TruSignal SpO₂ parameter. The pitch of the audible tone is directly related to the calculated saturation value. As the saturation value increases, the pitch frequency increases. As the saturation value decreases, the pitch frequency decreases. This audible tone is silenced while an alarm sounds or the **PULSE VOLUME** is set to **0**. Refer to “Menu Settings” in this section.

Procedures

1. Select a sensor that is appropriate for the patient and the clinical situation.

NOTE: Use only TruSignal OxiTip+ sensors and interconnect cables. Use of another pulse oximetry cable will have an adverse effect on performance. Do not attach any cable that is intended for computer use to the sensor port. Do not connect any device other than TruSignal-approved sensor to the sensor connector.

WARNING

Do not use a damaged sensor or one with exposed electrical contacts. Do not use sensor, cables, or connectors that appear damaged.

2. Following the directions for use supplied with the sensor, apply the sensor to the patient.

WARNINGS

Patient safety:

If the sensor is not applied properly, the patient's skin could be injured or the ability of the V100 Monitor to measure oxygen saturation could be compromised. For example, a clip-on sensor should never be taped shut. Taping the sensor could damage the patient's skin or impair the venous return, thus causing venous pulsation and inaccurate measurement of oxygen saturation.

Excessive pressure from the sensor may cause necrosis of the skin.

For additional warnings and information, refer to the TruSignal sensor's directions for use.

Monitor performance:

When an SpO₂ sensor is on a limb that has a blood pressure cuff, the SpO₂ data will not be valid when the cuff is inflated. If SpO₂ readings are required during the entire blood pressure determination, attach the SpO₂ sensor to the limb opposite the one with the blood pressure cuff.

Remove nail polish and artificial nails. Placing a sensor on a polished or an artificial nail may affect accuracy.

CAUTIONS

Patient safety:

Do not place any clip-on sensor in a patient's mouth or on a patient's nose or toe.

Do not place a clip-on finger sensor on a patient's thumb or across a child's foot or hand.

The sensor disconnect error message and associated alarm indicate that the sensor is either disconnected or the wiring is faulty. The user should check the sensor connection and, if necessary, replace the sensor, interconnect cable, or both.

Observe the sensor site frequently to assure adequate distal circulation. Sensor sites should be checked at least every 2 hours and rotated at least every 4 hours.

Monitor performance:

Placing a sensor distal to an arterial line may interfere with adequate arterial pulsation and compromise the measurement of SpO₂.

Place the sensor so that the LEDs and the photodiode are opposite each other.

3. Plug the SpO₂ sensor into the SpO₂ interconnect cable. Then plug the SpO₂ interconnect cable into the SpO₂ sensor connector.
4. Proceed with monitoring. SpO₂ measurements run continuously and can run simultaneously with other measurements.

Alarms

SpO₂ Hold-off Period

The hold-off period is defined as the 10 seconds that follows when the SpO₂ parameter switches from ready mode to operate mode. This hold-off period helps prevent any nuisance alarms.

Parameter status alarms are not displayed and the derived SpO₂ value is not checked against user-set limits while the SpO₂ hold-off period is active.

Alarm Timer

When an SpO₂ sensor is on for less than 2 minutes this is considered "spot mode." The SpO₂ --- SENSOR OFF FINGER and SpO₂ **E25** LOST PULSE alarms are generated as low-priority alarms if they occur within the spot mode time. While in spot mode, the length of spot mode operation is further increased by taking a manual NIBP determination.

Under all other conditions, these alarms are generated as high-priority alarms. If the low-priority alarms are not acknowledged within 1 minute, they escalate to high-priority alarms.

Specifications

Specifications	
Measurement range	
SpO ₂	1 to 100%
Pulse rate	30 to 250 bpm
Perfusion range	0.03 to 20%
Accuracy*	
Saturation	
Adult*	70 to 100% ±2 digits whichever is greater, (without motion)
Neonate*	70 to 100% ±3 digits (without motion)
Adult/Neonate**	70 to 100% ±3 digits (during clinical motion)
Low perfusion	70 to 100% ±2 digits (during clinical low perfusion)
Pulse rate	
Adult /Neonate	30 to 250 bpm: ± 2 digits or ± 2%, whichever is greater, (without motion) 30 to 250 bpm: ± 5 digits (during motion)
Low perfusion	30 to 250 bpm: ± 3 digits
<p>*SpO₂ measurement accuracy is based on deep hypoxia studies using OxyTip+ sensors on healthy adult volunteer subjects. Arterial blood samples were analyzed simultaneously on multiple CO-oximeters. This variation equals plus or minus one standard deviation. Plus or minus one standard deviation encompasses 68% of the population.</p> <p>**Applicability: OXY-AF and OXY-AP sensors.</p> <p>NOTE: Accuracy may vary for some sensors; always check the instructions for the sensor.</p>	

Specifications: Sensor Accuracy	
Sensor model	SpO ₂ range 70% to 100%
OxyTip+	
OXY-F-UN	±2 digits without motion
OXY-W-UN	±2 digits without motion
OXY-E-UN	±2 digits without motion
OXY-SE	±2 digits without motion
OXY-AP	±2 digits without motion
OXY-AF	±2 digits without motion
OXY-F2-GE	±2 digits without motion
OXY-F4-GE	±2 digits without motion
OXY-E2-GE	±2 digits without motion
OXY-E4-GE	±2 digits without motion
Sensor light source	
Wavelength*	Infrared: 930 to 950 nm (nominal) Red 650 to 670 nm (nominal)
Average power	< 1 mW
* Information about wavelength range can be especially useful to clinicians.	

Factory Default Settings

SpO ₂ (%) HIGH alarm limit	100
SpO ₂ (%) LOW alarm limit	90
Line frequency mode	60 (for 60 Hz)

GE Medical Systems *Information Technologies* Patents

6,397,092; 6,748,253; 6,505,133; 7,062,307; 5,766,127; 5,503,148; 5,934,277;
6,385,471; 6,714,803; 6,987,994; 6,408,198; 6,434,408; 6,839,582; 6,505,060;
6,510,329; 6,650,918; 7,139,599; 6,707,257; 6,720,734; 6,825,619 pending.

Troubleshooting

This section discusses potential difficulties and suggestions for resolving them. If the difficulty persists, contact a qualified service person or your local representative. The service manual, which is for use by qualified service personnel, provides additional troubleshooting information.

PROBLEM: The pulse amplitude bar indicates a pulse, but no oxygen saturation or pulse rate values appear on the screen.

CAUSE:

- Excessive patient motion may be making it impossible for the SpO₂ function to find a pulse pattern.
- The sensor may be damaged.
- The patient's perfusion may be too low to allow the SpO₂ function to measure saturation and pulse rate.

SOLUTION:

Check the patient.

- If possible, keep the patient still; check whether the SpO₂ sensor is applied securely and properly, and replace it if necessary; use the PIR pulsatile value to determine the strength of the signal and move the sensor to a new site; or use a disposable adhesive sensor that may tolerate more motion.
- Replace the sensor.

PROBLEM: The SpO₂ value or the pulse rate changes rapidly; the pulse amplitude bar is erratic.

CAUSE:

- Excessive patient motion may be making it impossible for the SpO₂ function to find a pulse pattern.
- An electro-surgical unit (ESU) may be interfering with performance.

SOLUTION:

Check the patient.

- If possible, keep the patient still; check whether the sensor is applied securely and properly, and replace it if necessary; use the PIR pulsatile value to determine the strength of the signal and move the sensor to a new site; use a sensor that tolerates more motion.

If an ESU is interfering:

- Move the SpO₂ cable as far from the ESU as possible.
- Plug the monitor and the ESU into different AC circuits.
- Move the ESU ground pad as close to the surgical site as possible.
- The sensor may need to be replaced with a new sensor.

PROBLEM: The oxygen saturation measurement does not correlate with the value calculated from a blood gas determination.

CAUSE:

- The SpO₂ calculation may not have correctly adjusted for the effects of pH; temperature; CO₂; fetal hemoglobin; or 2,3-DPG.
- Accuracy can be affected by incorrect sensor application or use; intravascular dyes; bright light; excessive patient movement; venous pulsations; electrosurgical interference; and placement of a sensor on an extremity that has a blood pressure cuff, arterial catheter, or intravascular line.

SOLUTION:

- Check that calculations have been corrected appropriately for the relevant variable. In general, calculated saturation values are not as reliable as direct laboratory hemoximeter measurements.
- If there is excessive light, cover the sensor with opaque material.
- Circulation distal to the sensor site should be checked routinely. Refer to the TruSignal sensor's directions for use supplied with the sensor for requirements on moving the sensor to another site to ensure adhesion, skin integrity, and correct optical alignment. If skin integrity changes, move the sensor to another site.
- Try to keep the patient still, or change the sensor site to one with less motion.
- Observe all instructions, warnings, and cautions in this manual and in the directions for use of the sensor.

PROBLEM: A valid SpO₂ signal was present but has disappeared.

CAUSE:

- An NIBP determination on the same limb is in progress.

SOLUTION:

Check the patient.

- An alarm message code appears on the screen, and the audible alarm will sound immediately.
- Move the sensor to the arm that is not connected to a blood pressure cuff.

PROBLEM: An **E21** REPLACE SENSOR error code has been detected.

CAUSE:

- The sensor or cable may be the wrong type or defective, the cabling may be improperly connected.

SOLUTION:

Check the patient.

- If possible, keep the patient still; check whether the proper sensor/cable is applied securely and properly, and replace it if necessary.
- Disconnect and reconnect the sensor.

PROBLEM: An **E20 SENSOR DISCONNECTED** error code has been detected, but the sensor is still connected.

CAUSE:

- The sensor is not completely connected. The interconnect cable or sensor wiring is faulty.
- Ensure the appropriate sensor and cable are being used.

SOLUTION:

Check the patient.

- Check the sensor connection to the interconnect cable and the interconnect cable connection to the monitor. Then, if needed, replace the sensor or the interconnect cable.
- Use only compatible sensors and cables.

9 Nellcor OXIMAX SpO₂

For your notes

Description



The SpO₂ parameter in the V100 Monitor is available in three different leading technologies: Ohmeda TruSignal, Nellcor and Masimo SET. Please refer to the front of your monitor to see which SpO₂ technology your monitor contains. If your monitor contains this parameter, the SpO₂ technology logo will be on the front fascia of the monitor. ***This section refers to Nellcor SpO₂ technology.***

Pulse rate derived from SpO₂ appears in the **Pulse Rate** window and is continuously updated. A tone sounds at a rate corresponding to the pulse rate and at a pitch corresponding to the SpO₂ saturation level. The pitch is highest at 100% oxygen saturation, and it continuously decreases as the saturation level falls. The monitor displays a pulse amplitude bar. The pulse amplitude bar graph is proportional to the arterial blood flow.

The parameter automatically switches on when a sensor is connected to the monitor.

Audible and visible alarms occur when SpO₂ levels are outside the alarm limits. When a parameter status alarm occurs, an alarm message code appears in the SpO₂ window.

NOTE: Limit alarms, printing, and trending are not available for the first 10 seconds of SpO₂ monitoring.

WARNINGS

Do not use the SpO₂ parameter during magnetic resonance imaging (MRI). Adverse reactions include potential burns to patients as a result of contact with attachments heated by the MRI radio frequency pulse, potential degradation of the magnetic resonance image, and potential reduced accuracy of SpO₂ measurements. Always remove oximetry devices and attachments from the MRI environment before scanning a patient.

The use of cardio-green and other intravascular dyes at certain concentrations may affect the accuracy of the SpO₂ measurement.

The SpO₂ parameter is calibrated to read functional arterial oxygen saturation. Significant levels of dysfunctional hemoglobins such as carboxyhemoglobin or methemoglobin may affect the accuracy of the SpO₂ measurement.

As with all medical equipment, carefully route patient cabling to reduce the possibility of patient entanglement or strangulation.

A functional tester cannot be used to assess the accuracy of a pulse oximeter probe or a pulse oximeter monitor.

Nellcor® is a trademark of Nellcor Puritan Bennett

WARNINGS

Pulse oximetry readings and pulse signals can be affected by certain environmental conditions, sensor application errors, and certain patient conditions. See the appropriate sections of this manual for specific safety information.

The use of accessories, transducers, and cables other than those specified may result in increased emission and/or decreased immunity and inaccurate readings of the monitor.

CAUTIONS

As with any clip-on sensor, pressure is exerted. The clinician should be cautious in using a clip-on sensor on patients with compromised circulation (e.g., because of peripheral vascular disease or vasoconstricting medications).

Do not perform any testing or maintenance on a sensor while it is being used to monitor a patient.

Bright light sources (e.g., infrared heat lamps, bilirubin lights, direct sunlight, operating room lights) may interfere with the performance of the SpO₂ function. To prevent such interference, cover the sensor with opaque material.

NOTES

- A patient's vital signs may vary dramatically during the use of cardiovascular agents such as those that raise or lower blood pressure or those that increase or decrease pulse rate.
- The V100 Monitor that is labeled with Nellcor Technology is compatible only with Nellcor OxiMax sensors and Nellcor sensor extension cable.
- Software development, software validation, and Risk and Hazard Analysis has been performed to a registered quality system.
- User or patient-applied parts are latex-free.

Configuration Settings Associated with SpO₂

There are two configuration settings associated with this parameter: response mode (**n0d**) and *SatSeconds*[™] (**SAt**).

Response mode (**n0d**) allows the user to specify the averaging technique or how quickly the reported SpO₂ value responds to changes in the patient's saturation. This will also effect time to alarm. Choose **Mode 1** (Normal Response; default setting) for the general patient population. Choose **Mode 2** (Fast Response) when patients are active as in exercise protocols.

SatSeconds™

With traditional alarm management, upper and lower alarm limits are set for monitoring SpO₂. During monitoring, as soon as an alarm limit is violated by as little as one percentage point, an audible alarm immediately sounds. When the % SpO₂ fluctuates near an alarm limit, the alarm sounds each time the limit is violated. To prevent these nuisance alarms, the V100 Monitor uses the *SatSeconds* technique. The *SatSeconds* technique (**SAt**) controls the time that the % SpO₂ level may fall outside the alarm before an audible alarm sounds. Choose either **0, 10, 25, 50, or 100** seconds. If **0** is chosen this limit hold-off feature is disabled.

The *SatSeconds* number is calculated by taking the amount the current saturation value is out of limits and multiplying it by the amount of time it has been out of those limits. For example: if the lower limit is set to 95% and the patient's saturation is 90%, the amount out of limit is 5%. If the *SatSeconds* feature is set to 50, the alarm would sound in 10 seconds, because 5% saturation (out of limits) multiplied by 10 seconds (time out of limit) equals 50 *SatSeconds*.

The *SatSeconds* "Safety Net" is for patients with saturation levels having frequent excursions below the limit, but not staying below the limit long enough for the *SatSeconds* time setting to be reached. When 3 or more limit violations occur within 60 seconds, an alarm sounds even if the *SatSeconds* time setting has not been reached.

Buttons Associated with SpO₂

There are no buttons associated with this parameter.

Windows Associated with SpO₂

There is one window associated with this parameter: **SpO₂**. While in offline mode, nothing is displayed in the **SpO₂** window. When in ready mode and the parameter senses that a sensor is connected, a single dash (-) appears in this window. When it is in operate mode and the parameter is reporting valid data, the derived SpO₂ value appears in this window and updates continuously. The values are displayed in %.

NOTE: If SpO₂ is the source for pulse rate, the **Pulse Rate** window is associated with this parameter. Refer to the "Pulse Rate" Section for more information.

Indicators Associated with SpO₂

There is one indicator associated with this parameter: the pulse amplitude indicator bar. The red LED bar flashes to indicate that pulse rate measurements are being derived from SpO₂ signals and the height of the bar is proportional to the arterial blood flow.

User Settings

Limit settings

There are two limit settings associated with this parameter: **HIGH** and **LOW**. The range for **HIGH** is 71 to 100%. The range for **LOW** is 70 to 99%. The settings appear in increments of 1%.

Menu Settings

The **PULSE VOLUME** menu setting is associated with the SpO₂ parameter. This option lets you adjust the volume of the tone that sounds after each detected pulse. It can be adjusted from 0 - 10 (10 being the loudest). If you set the volume to zero, no tone will sound.

Sounds Associated with SpO₂

An audible tone is provided by the monitor for each pulse detected by the Nellcor SpO₂ parameter. The pitch of the audible tone is directly related to the calculated saturation value. As the saturation value increases, the pitch frequency increases. As the saturation value decreases, the pitch frequency decreases. This audible tone is silenced while an alarm sounds or the **PULSE VOLUME** is set to **0**. Refer to "Menu Settings" in this section.

Procedures

1. Select a sensor that is appropriate for the patient and the clinical situation. Verify that the monitor's patient type and sensor type match. Sensor sizing must be correct to for the SpO₂ algorithm to function properly.

NOTE: To assure optimal performance, use only Nellcor sensors, which are available from GE Medical Systems *Information Technologies-Accessories and Supplies* or from Nellcor or its local representative. Use only Nellcor OxiMAX sensors with PURPLE or WHITE plugs (connectors) and cables. Use of another pulse oximetry cable will have an adverse effect on performance. Do not attach any cable that is intended for computer use to the sensor port. Do not connect any device other than a Nellcor OxiMAX sensor to the sensor connector.

WARNING

Do not use a damaged sensor or one with exposed electrical contacts. Do not use sensor, cables, or connectors that appear damaged.

2. Following the directions for use supplied with the sensor, apply the sensor to the patient.

WARNINGS

Patient safety:

If the sensor is not applied properly, the patient's skin could be injured or the ability of the V100 Monitor to measure oxygen saturation could be compromised. For example, a clip-on sensor should never be taped shut. Taping the sensor could damage the patient's skin or impair the venous return, thus causing venous pulsation and inaccurate measurement of oxygen saturation.

Excessive pressure from the sensor may cause necrosis of the skin.

For additional warnings and information, refer to the Nellcor sensor's directions for use.

Monitor performance:

When an SpO₂ sensor is on a limb that has a blood pressure cuff, the SpO₂ data will not be valid when the cuff is inflated. If SpO₂ readings are required during the entire blood pressure determination, attach the SpO₂ sensor to the limb opposite the one with the blood pressure cuff.

Remove nail polish and artificial nails. Placing a sensor on a polished or an artificial nail may affect accuracy.

CAUTIONS

Patient safety:

Do not place any clip-on sensor in a patient's mouth or on a patient's nose or toe.

Do not place a clip-on finger sensor on a patient's thumb or across a child's foot or hand.

The sensor disconnect error message and associated alarm indicate that the sensor is either disconnected or the wiring is faulty. The user should check the sensor connection and, if necessary, replace the sensor, cable, or both.

Observe the sensor site frequently to assure adequate distal circulation. Sensor sites should be checked at least every 2 hours and rotated at least every 4 hours.

Monitor performance:

Placing a sensor distal to an arterial line may interfere with adequate arterial pulsation and compromise the measurement of SpO₂.

Place the sensor so that the LEDs and the photodiode are opposite each other.

3. Plug the SpO₂ sensor into the SpO₂ sensor extension cable. Then plug the SpO₂ sensor extension cable into the SpO₂ sensor connector.
4. Proceed with monitoring. SpO₂ measurements run continuously and can run simultaneously with other measurements.

Alarms

SpO₂ Hold-off Period

The hold-off period is defined as the 10 seconds that follows when the SpO₂ parameter switches from ready mode to operate mode. This hold-off period helps prevent any nuisance alarms.

Parameter status alarms are not displayed and the derived SpO₂ value is not checked against user-set limits while the SpO₂ hold-off period is active.

Alarm Timer

When an SpO₂ sensor is on for less than 2 minutes this is considered "spot mode." The SpO₂ --- SENSOR OFF FINGER and **E25** SpO₂ LOST PULSE alarms are generated as low-priority alarms if they occur within the spot mode time. While in spot mode, the length of spot mode operation is further increased by taking a manual NIBP determination.

Under all other conditions, these alarms are generated as high-priority alarms. If the low-priority alarms are not acknowledged within 1 minute, they escalate to high-priority alarms.

Specifications

Specifications	
Measurement range	
SpO ₂	1 to 100%
Pulse rate	20 to 250 bpm
Perfusion range	0.03 to 20%
Accuracy	
Saturation	
Adult*	70 to 100% ±2 digits
Neonate*	70 to 100% ±3 digits
Low perfusion**	70 to 100% ±2 digits
Pulse Rate	
Adult and neonate	40 to 250 bpm ±3 digits
Low perfusion**	40 to 250 bpm ±3 digits
<p>*Adult specifications are shown for OxiMax MAX-A and MAX-N sensors with the N-600. Saturation accuracy will vary by sensor type. This variation equals plus or minus one standard deviation. Plus or minus one standard deviation encompasses 68% of the population. Accuracy is based on deep hypoxia studies on healthy adult volunteer subjects. Arterial blood samples were analyzed simultaneously on multiple CO-oximeters</p> <p>**Applicability: OxiMax MAX-A, MAX-AL, MAX-P, MAX-I, and MAX-N sensors.</p>	

Specifications: Nellcor OxiMAX sensor accuracy	
NOTE: All Nellcor OxiMAX sensors must be used with the NELL cable; the SCP-10 cable. RS-10 and Oxisensor II sensors are not compatible with the V100 Vital Signs Monitor.	
Sensor Model	SpO ₂ Range 70% to 100%
OxiMAX	
MAX-A, MAX-AL	± 2 digits
MAX-N (adult)	± 2 digits
MAX-N* (neonate)	± 3 digits
MAX-P	± 2 digits
MAX-I	± 2 digits
MAX-FAST	± 2 digits

Nellcor OXIMAX SpO₂: Specifications

Specifications: Nellcor OxIMAX sensor accuracy	
SC-A (adult)	± 2 digits
SC-PR (neonate)	± 3 digits
SC-NEO	± 3 digits
MAX-R**	± 3.5 digits
OxiCliq	
OxiCliq A	± 2.5 digits
OxiCliq P	± 2.5 digits
OxiCliq N (adult)	± 2.5 digits
OxiCliq N* (neonate)	± 3.5 digits
OxiCliq I	± 2.5 digits
Reusable sensor models	
D-YS (infant to adult)	± 3 digits
D-YS (neonate)	± 4 digits
D-YS & D-YSE	± 3.5 digits
D-YS & D-YSPD	± 3.5 digits
DS-100A	± 3 digits
OXI-A/N (adult)	± 3 digits
OXI-A/N (neonate)	± 4 digits
OXI-P/I	± 3 digits
Neonatal sensor accuracy	When sensors are used on neonatal subjects as recommended, the specified accuracy range is increased by ±1 digit, as compared to adult usage, to account for the theoretical effect on oximeter measurements of fetal hemoglobin in neonatal blood. For example, MAX-N accuracy on neonates is ±3 digits, rather than ±2 digits.
Sensor light source	
Wavelength***	Infrared: 890 nm (nominal) Red: 660 nm (nominal)
Power dissipation	Infrared: 22.5 mW (max) Red: 30 mW (max)
<p>* The MAX-N, D-YS, OXI-A/N, and OxiCliq N were tested on patients >40 kg.</p> <p>** The accuracy specification has been determined between saturations of 80%-100%.</p> <p>*** Information about wavelength range can be especially useful to clinicians.</p>	

Factory Default Settings

SpO ₂ (%) HIGH alarm limit	100
SpO ₂ (%) LOW alarm limit	90
Response mode	1 (for Mode 1: Normal response)
SatSeconds™	0

Nellcor Patents

Re.35,122; 4,802,486; 4,869,254; 4,928,692; 4,934,372; 4,960,126; 5,078,136;
5,485,847; 5,743,263; 5,865,736; 6,035,223; 6,298,252; 6,463,310; 6,591,123;
6,675,031; 6,708,049; 6,801,797 and international equivalents.

Troubleshooting

This section discusses potential difficulties and suggestions for resolving them. If the difficulty persists, contact a qualified service person or your local representative. The service manual, which is for use by qualified service personnel provides additional troubleshooting information.

PROBLEM: The pulse amplitude bar indicates a pulse, but no oxygen saturation or pulse rate values appear on the screen.

CAUSE:

- Excessive patient motion may be making it impossible for the SpO₂ function to find a pulse pattern.
- The sensor may be damaged.
- The patient's perfusion may be too low to allow the SpO₂ function to measure saturation and pulse rate.

SOLUTION:

Check the patient.

- If possible, keep the patient still; check whether the SpO₂ sensor is applied securely and properly, and replace it if necessary; move the sensor to a new site; or use a disposable adhesive sensor that may tolerate more motion.
- Replace the sensor.

PROBLEM: The SpO₂ value or the pulse rate changes rapidly; the pulse amplitude bar is erratic.

CAUSE:

- Excessive patient motion may be making it impossible for the SpO₂ function to find a pulse pattern.
- An electro-surgical unit (ESU) may be interfering with performance.

SOLUTION:

Check the patient.

- If possible, keep the patient still; check whether the sensor is applied securely and properly, and replace it if necessary; move the sensor to a new site; use a sensor that tolerates more motion.

If an ESU is interfering:

- Move the SpO₂ cable as far from the ESU as possible.
- Plug the monitor and the ESU into different AC circuits.
- Move the ESU ground pad as close to the surgical site as possible.
- The sensor may need to be replaced with a new sensor.
- If the patient weighs less than 3 kg or more than 40 kg, apply an OxiMax, reusable sensor (except DS-100, OXI-A/N, OXI-P/I), or OxiCliq oxygen transducer to an appropriate site. These sensors have Faraday shields which provide added protection from high electronic noise and ambient light.

PROBLEM: The oxygen saturation measurement does not correlate with the value calculated from a blood gas determination.

CAUSE:

- The SpO₂ calculation may not have correctly adjusted for the effects of pH; temperature; CO₂; fetal hemoglobin; or 2,3-DPG.
- Accuracy can be affected by incorrect sensor application or use; intravascular dyes; bright light; excessive patient movement; venous pulsations; electrosurgical interference; and placement of a sensor on an extremity that has a blood pressure cuff, arterial catheter, or intravascular line.

SOLUTION:

- Check that calculations have been corrected appropriately for the relevant variable. In general, calculated saturation values are not as reliable as direct laboratory hemoximeter measurements.
- If there is excessive light, cover the sensor with opaque material.
- Circulation distal to the sensor site should be checked routinely. Refer to the Nellcor sensor's directions for use supplied with the sensor for requirements on moving the sensor to another site to ensure adhesion, skin integrity, and correct optical alignment. If skin integrity changes, move the sensor to another site.
- Try to keep the patient still, or change the sensor site to one with less motion.
- Observe all instructions, warnings, and cautions in this manual and in the directions for use of the sensor.

PROBLEM: A valid SpO₂ signal was present but has disappeared.

CAUSE:

- An NIBP determination on the same limb is in progress.

SOLUTION:

Check the patient.

- An alarm message code appears on the screen, and the audible alarm will sound immediately.
- Move the sensor to the arm that is not connected to a blood pressure cuff.

PROBLEM: An **E21** REPLACE SENSOR error code has been detected.

CAUSE:

- The sensor or cable may be the wrong type or defective, the cabling may be improperly connected.

SOLUTION:

Check the patient.

- If possible, keep the patient still; check whether the proper sensor/cable is applied securely and properly, and replace it if necessary.
- Disconnect and reconnect the sensor.

PROBLEM: An **E20 SENSOR DISCONNECTED** error code has been detected, but the sensor is still connected.

CAUSE:

- The sensor is not completely connected. The sensor extension cable or sensor wiring is faulty.

SOLUTION:

Check the patient.

- Check the sensor connection to the sensor extension cable and the sensor extension cable connection to the monitor. Then, if needed, replace the sensor or the sensor extension cable.

10 Masimo SET SpO₂

For your notes

Description



The SpO₂ parameter in the V100 Monitor is available in three different leading technologies: Ohmeda TruSignal, Nellcor and Masimo SET. Please refer to the front of your monitor to see which SpO₂ technology your monitor contains. If your monitor contains this parameter, the SpO₂ technology logo will be on the front fascia of the monitor. ***This section refers to Masimo SET SpO₂ technology.***

Functional oxygen saturation (SpO₂) of arterial blood is noninvasively and continuously monitored in the V100 Monitor using pulse oximetry technology from Masimo SET. Functional SpO₂ is the ratio of oxygenated hemoglobin to hemoglobin that is capable of transporting oxygen. This ratio, expressed as a percentage, is shown in the **SpO₂** window, which is continually updated.

Pulse rate when associated with SpO₂ appears in the **Pulse Rate** window. A tone sounds at a rate corresponding to the pulse rate and at a pitch corresponding to the SpO₂ saturation level. The pitch is highest at 100% oxygen saturation, and it becomes lower as the saturation level falls. The monitor displays a pulse amplitude bar. The pulse amplitude bar graph is proportional to the arterial blood flow.

The parameter automatically switches on when a sensor is connected to the monitor.

Audible and visible alarms occur when SpO₂ levels are outside the alarm limits. When a parameter status alarm code occurs, an alarm message appears in the **SpO₂** window.

NOTE: Limit alarms, printing, and trending are not available for the first 10 seconds of SpO₂ monitoring.

Indications and Contraindications

The SpO₂ parameter is indicated for use in continuous, noninvasive monitoring of functional oxygen saturation and in providing pulse rate data as a component of the CARESCAPE V100 Vital Signs Monitor. This device is not designed, sold, or intended for use except as indicated.

Masimo SET®, LNOP, and LNCS are trademarks of Masimo Corporation. Possession or purchase of this device does not convey any express or implied license to use the device with replacement parts which would, alone, or in combination with this device, fall within the scope of one or more of the patents relating to the device.

WARNINGS

Do not use the SpO₂ parameter during magnetic resonance imaging (MRI). Adverse reactions include potential burns to patients as a result of contact with attachments heated by the MRI radio frequency pulse, potential degradation of the magnetic resonance image, and potential reduced accuracy of SpO₂ measurements. Always remove oximetry devices and attachments from the MRI environment before scanning a patient.

As with all medical equipment, carefully route patient cabling to reduce the possibility of patient entanglement or strangulation.

The use of cardio-green and other intravascular dyes at certain concentrations may affect the accuracy of the SpO₂ measurement.

The SpO₂ parameter is calibrated to read functional arterial oxygen saturation. Significant levels of dysfunctional hemoglobins such as carboxyhemoglobin or methemoglobin may affect the accuracy of the SpO₂ measurement.

A functional tester cannot be used to assess the accuracy of a pulse oximeter probe or a pulse oximeter monitor.

CAUTIONS

If any measurement does not seem reasonable, first check the patient's vital signs by alternate means and then check the pulse oximeter for proper functioning.

Inaccurate measurements may be caused by:

- ◆ Incorrect sensor application or use
- ◆ Significant levels of dysfunctional hemoglobins (e.g., carboxyhemoglobin or methemoglobin)
- ◆ Intravascular dyes such as indocyanine green or methylene blue
- ◆ Exposure to excessive illumination, such as surgical lamps (especially ones with xenon light source), bilirubin lamps, fluorescent lights, infrared heating lamps, or direct sunlight (exposure to excessive illumination can be corrected by covering the sensor with a dark or opaque material)
- ◆ venous pulsations
- ◆ placement of sensor on an extremity with a blood pressure cuff, arterial catheter, or intravascular line

The pulse oximeter can be used during defibrillation, but the readings may be inaccurate for a short time.

CAUTIONS

Loss of pulse signal can occur in any of the following situation:

- ◆ the sensor is too tight
- ◆ there is excessive illumination from light sources such as surgical lamp, a bilirubin lamp, or sunlight
- ◆ a blood pressure cuff is inflated on the same extremity as the one with a SpO₂ sensor attached
- ◆ the patient has hypotension, severe vasoconstriction, severe anemia, or hypothermia
- ◆ there is arterial occlusion proximal to the sensor
- ◆ the patient is in cardiac arrest or is in shock

Sensors:

Before use, carefully read the Masimo sensor directions for use.

Use only Masimo oximetry sensors for SpO₂ measurements. Other oxygen transducers (sensors) may cause improper SpO₂ performance.

Tissue damage can be caused by incorrect application or use of a Masimo sensor, for example by wrapping the sensor too tightly. Inspect the sensor site as directed in the sensor Directions for Use to ensure skin integrity and correct positioning and adhesion of the sensor.

Do not use damaged Masimo sensors. Do not use a Masimo sensor with exposed optical components. Do not immerse the sensor in water, solvents, or cleaning solutions (the sensors and connectors are not waterproof). Do not sterilize by irradiation, steam, or ethylene oxide. See the cleaning instructions in the directions for use for reusable Masimo sensors.

Do not use damaged patient cables. Do not immerse the patient cables in water, solvents, or cleaning solutions (the patient cable connectors are not waterproof). Do not sterilize by irradiation, steam, or ethylene oxide. See the cleaning instructions in the directions for use for reusable Masimo patient cables.

The use of accessories, transducers, and cables other than those specified may result in increased emission and/or decreased immunity and inaccurate readings of the monitor.

As with any clip-on sensor, pressure is exerted. The clinician should be cautious in using a clip-on sensor on patients with compromised circulation (e.g., because of peripheral vascular disease or vasoconstricting medications).

Do not perform any testing or maintenance on a sensor while it is being used to monitor a patient.

NOTES

- A patient's vital signs may vary dramatically during the use of cardiovascular agents such as those that raise or lower blood pressure or those that increase or decrease pulse rate.
- The V100 Vital Signs Monitor that is labeled with Masimo SET Technology is compatible only with Masimo SET sensors.
- Software development, software validation, and Risk and Hazard Analysis has been performed to a registered quality system.
- User or patient-applied parts are latex-free.

Configuration Settings Associated with SpO₂

There are three configuration settings associated with this parameter: averaging time (**n0d**), FastSAT (**Sat**), and sensitivity mode (**Sen**).

Averaging Time (**n0d**) allows you to choose the number of seconds over which SpO₂ data is averaged. Choose **4** to **16** in steps of 2 (alarms are delayed by this amount).

NOTE: Increased averaging time effects time to alarm for saturation and pulse rate limits.

FastSAT (**Sat**) allows you to choose **0** (for Off) or **1** (for On). If FastSAT is configured to **1** (On), the SpO₂ values are calculated quicker.

Sensitivity mode (**Sen**) setting allows you to adjust the thresholds for calculating SpO₂ values under low perfusion conditions. Choose **1** (low perfusion-Maximized), **2** (low perfusion-Default), or **3** (adaptive probe off).

NOTE: Adaptive probe off provides a mode with enhanced detection of "probe off" conditions. It is intended to be used if normal mode is not detecting "probe off" with some sensors and conditions.

Buttons Associated with SpO₂

There are no buttons associated with this parameter.

Windows Associated with SpO₂

There is one window associated with this parameter: **SpO₂**. While in offline mode, nothing is displayed in the **SpO₂** window. When in ready mode and the parameter senses that a sensor is connected, a single dash (-) appears in this window. When it is in operate mode and the parameter is reporting valid data, the derived SpO₂ value appears in this window and updates continuously. The values are displayed in %.

NOTE: If SpO₂ is the source for pulse rate, the **Pulse Rate** window is associated with this parameter. Refer to the "Pulse Rate" Section for more information.

Indicators Associated with SpO₂

There is one indicator associated with this parameter: the pulse amplitude indicator bar. The red LED bar flashes to indicate that pulse rate measurements are being derived from SpO₂ signals and the height of the bar is proportional to the arterial blood flow.

User Settings

Limit settings

There are two limit settings associated with this parameter: **HIGH** and **LOW**. The range for **HIGH** is 71 to 100%. The range for **LOW** is 70 to 99%. The settings appear in increments of 1%.

Menu Settings

The **PULSE VOLUME** menu setting is associated with the SpO₂ parameter. This option lets you adjust the volume of the tone that sounds for each pulse detected. It can be adjusted from 0 to 10 (10 being the loudest). If you set the volume to zero, no tone will sound.

Sounds Associated with SpO₂

An audible tone is provided by the monitor for each pulse detected by the Masimo SET SpO₂ parameter. The pitch of the audible tone is directly related to the calculated saturation value. As the saturation value increases, the pitch frequency increases. As the saturation value decreases, the pitch frequency decreases. This audible tone is silenced while an alarm sounds or the **PULSE VOLUME** is set to **0**. Refer to "Menu Settings" in this section.

Procedures

1. Select a sensor that is appropriate for the patient and the clinical situation.

WARNING

Do not use a damaged sensor or one with exposed electrical contacts.

NOTE: Use only Masimo sensors, which are available from Masimo Corporation and GE Medical Systems *Information Technologies-Accessories and Supplies*.

2. Following the directions for use supplied with the sensor, apply the sensor to the patient.

WARNINGS

Patient safety:

If you fail to apply the sensor properly, the patient's skin could be injured or the ability of the V100 Monitor to measure oxygen saturation could be compromised. For example, a clip-on sensor should never be taped shut. Taping the sensor could damage the patient's skin or impair the venous return, thus causing venous pulsation and inaccurate measurement of oxygen saturation.

Excessive pressure from the sensor may cause necrosis of the skin.

Monitor performance:

When an SpO₂ sensor is on a limb that has a blood pressure cuff, the SpO₂ data will not be valid when the cuff is inflated. If SpO₂ readings are required during the entire blood pressure determination, attach the SpO₂ sensor to the limb opposite the one with the blood pressure cuff.

Remove nail polish and artificial nails. Placing a sensor on a polished or an artificial nail may affect accuracy.

CAUTIONS

Patient safety:

Do not place any clip-on sensor in a patient's mouth or on a patient's nose or toe.

Do not place a clip-on finger sensor on a patient's thumb or across a child's foot or hand.

Observe the sensor site to assure adequate distal circulation. Sensor sites should be checked at least every 2 hours and rotated at least every 4 hours.

Monitor performance:

Placing a sensor distal to an arterial line may interfere with adequate arterial pulsation and compromise the measurement of SpO₂.

Place the sensor so that the LEDs and the photodiode are opposite each other.

3. Plug the SpO₂ sensor into the SpO₂ sensor extension cable. Then plug the SpO₂ sensor extension cable into the SpO₂ sensor connector.
4. Proceed with monitoring. SpO₂ measurements run continuously and can run simultaneously with other measurements.

Alarms

SpO₂ Hold-off Period

The hold-off period is defined as the 10 seconds that follows when the SpO₂ parameter switches from ready mode to operate mode. This hold-off period helps prevent any nuisance alarms.

Parameter status alarms are not displayed and the derived SpO₂ value is not checked against user-set limits while the SpO₂ hold-off period is active.

Alarm Timer

When an SpO₂ sensor is on for less than 2 minutes this is considered "spot mode." The SpO₂ --- SENSOR OFF FINGER and **E25** SpO₂ LOST PULSE alarms are generated as low-priority alarms if they occur within the spot mode time. While in spot mode, the length of spot mode operation is further increased by taking a manual NIBP determination.

Under all other conditions, these alarms are generated as high-priority alarms. If the low-priority alarms are not acknowledged within 1 minute, they escalate to high-priority alarms.

Specifications

Specifications	
Measurement range	
SpO ₂	1 to 100%
Pulse rate	25 to 240 bpm
Perfusion range	0.02 to 20%
Accuracy and motion tolerance	
Saturation	
Without motion - adult/pediatric*	70 to 100% ± 2 digits
Without motion - neonate*	70 to 100% ± 3 digits
With motion - adult/pediatric/neo**†	70 to 100% ± 3 digits
Low perfusion‡	70 to 100% ± 2 digits 0 to 69% unspecified
Pulse rate	
Without motion	25 to 240 bpm ±3 digits
With motion	normal physiologic range 25 to 240 bpm ±5 digits
<p>* The Masimo SET SpO₂ parameter with LNOP-Adt sensors has been validated for no motion accuracy in human blood studies on healthy adult volunteers in induced hypoxia studies in the range of 70-100% SpO₂ against a laboratory co-oximeter and ECG monitor. This variation equals plus or minus one standard deviation. Plus or minus one standard deviation encompasses 68% of the population.</p> <p>**The Masimo SET SpO₂ parameter with LNOP-Adt sensors has been validated for motion accuracy in human blood studies on healthy adult volunteers in induced hypoxia studies while performing rubbing and tapping motions at 2 to 4 Hz at an amplitude of 1 to 2 cm and a nonrepetitive motion between 1 to 5 Hz at an amplitude of 2 to 3 cm in induced hypoxia studies in the range of 70-100% SpO₂ against a laboratory co-oximeter and ECG monitor. This variation equals plus or minus one standard deviation. Plus or minus one standard deviation encompasses 68% of the population.</p> <p>†The Masimo SET SpO₂ parameter with LNOP-Neo Pt sensors has been validated for neonatal motion accuracy in human blood studies on neonates while moving the neonate's foot at 2 to 4 cm against a laboratory co-oximeter and ECG monitor. This variation equals plus or minus, one standard deviation. Plus or minus one standard deviation encompasses 68% of the population.</p> <p>‡The Masimo SET SpO₂ parameter has been validated for low perfusion accuracy in bench top testing against a Biotek Index 2 stimulator and Masimo's simulator with signal strengths of greater than 0.02% and a % transmission of greater than 5% for saturations ranging from 70 to 100%. This variation equals plus or minus, one standard deviation. Plus or minus one standard deviation encompasses 68% of the population.</p>	

Masimo SET SpO₂: Specifications

Specifications: Masimo sensor accuracy	
Sensor model	SpO ₂ range 70% to 100%
LNOP	
LNOP ADT	± 2 digits without motion
LNOP NEO	± 3 digits without motion
LNOP NEO-L Foot Finger	± 3 digits without motion ± 2 digits without motion
LNOP NEO PT-L	± 3 digits without motion
LNOP Adtx	± 2 digits without motion
LNOP Pdtx	± 2 digits without motion
LNOP DCI	± 2 digits without motion
LNOP DCIP	± 2 digits without motion
LNOP Hi Fi-Neo/adult Foot Finger	± 3 digits without motion ± 2 digits without motion
LNOP Hi Fi-Infant/Ped	± 2 digits
LNOP Blue Infant Thumb/Toe*	± 3 digits (for 80-100) without motion ± 4 digits (for 60-80) without motion ± 3.3 digits (for 70-100) without motion
LNOP YI Multi-Site Foot/hand Finger/toe	± 3 digits without motion ± 2 digits without motion
LNOP DC-195	± 2 digits without motion
LNOP TC-I	± 3.5 digits without motion
LNCS	
LNCS TCI	± 3.5 digits without motion
LNCS DC-I	± 2 digits without motion
LNCS DC-IP	± 2 digits without motion
LNCS Adult Adtx	± 2 digits without motion
LNCS Ped Pdtx	± 2 digits without motion
LNCS Infant-L	± 2 digits without motion

Masimo SET SpO₂: Specifications

Specifications: Masimo sensor accuracy	
LNCS Neo PT-L	± 3 digits without motion
Resolution	
Saturation (% SpO ₂)	1%
Pulse rate (bpm)	1
Low perfusion performance	
0.02% Pulse amplitude and % transmission >5%	Saturation (% SpO ₂) ±2 digits Pulse rate ±3 digits
Interfering substances	Carboxyhemoglobin may erroneously increase readings. The level of increase is approximately equal to the amount of carboxyhemoglobin present. Dyes, or any substance containing dyes, that change usual arterial pigmentation may cause erroneous readings.
Sensor light source	
Wavelength*	Infrared: 905 nm (nominal) Red: 660 nm (nominal)
Power dissipation	Infrared: 22.5 mW (max) Red: 27.5 mW (max)
<p>*Masimo SET Technology with LNOP Blue sensors have been validated for no motion accuracy in human blood studies on neonatal, infant, and pediatric patients with congenital, cyanotic cardiac lesions in the range of 60% to 100% SpO₂ against a laboratory co-oximeter. This variation equals plus or minus one standard deviation, which encompasses 68% of the population.</p> <p>** Information about wavelength range can be especially useful to clinicians.</p>	

Factory Default Settings

SpO ₂ (%) HIGH alarm limit	100
SpO ₂ (%) LOW alarm limit	90
Averaging time	12 seconds
FastSAT mode	0 (for Off)
Sensitivity mode	2 (for Low Perfusion)

Masimo Patents

5,823,950; 5,758,644; 6,011,986; 6,501,975; 6,157,850; 6,263,222 and other applicable patents listed at: www.masimo.com/patents.htm.

Troubleshooting

This section discusses potential difficulties and suggestions for resolving them. If the difficulty persists, contact a qualified service person or your local representative.

The service manual, which is for use by qualified service personnel, provides additional troubleshooting information.

PROBLEM: The pulse amplitude bar indicates a pulse, but no oxygen saturation or pulse rate values appear on the screen.

CAUSE:

- ◆ Excessive patient motion may be making it impossible for the SpO₂ function to find a pulse pattern.
- ◆ The sensor may be damaged.
- ◆ The patient's perfusion may be too low to allow the SpO₂ function to measure saturation and pulse rate.

SOLUTION:

Check the patient.

- ◆ If possible, keep the patient still; check whether the SpO₂ sensor is applied securely and properly, and replace it if necessary; move the sensor to a new site; or use a disposable adhesive sensor that may tolerate more motion.
- ◆ Replace the sensor.

PROBLEM: The SpO₂ value or the pulse rate changes rapidly; the pulse amplitude bar is erratic.

CAUSE:

- ◆ Excessive patient motion may be making it impossible for the SpO₂ function to find a pulse pattern.
- ◆ An electro-surgical unit (ESU) may be interfering with performance.

SOLUTION:

Check the patient.

- ◆ If possible, keep the patient still; check whether the sensor is applied securely and properly, and replace it if necessary; move the sensor to a new site; use a sensor that tolerates more motion.

If an ESU is interfering:

- ◆ Move the SpO₂ cable as far from the ESU as possible.
- ◆ Plug the monitor and the ESU into different AC circuits.
- ◆ Move the ESU ground pad as close to the surgical site as possible.
- ◆ The sensor may be damp or may need to be replaced with a new sensor.

PROBLEM: The oxygen saturation measurement does not correlate with the value calculated from a blood gas determination.

CAUSE:

- ◆ The SpO₂ calculation may not have correctly adjusted for the effects of pH; temperature; CO₂; fetal hemoglobin; or 2,3-DPG.
- ◆ Accuracy can be affected by incorrect sensor application or use; intravascular dyes; bright light; excessive patient movement; venous pulsations; electrosurgical interference; and placement of a sensor on an extremity that has a blood pressure cuff, arterial catheter, or intravascular line.

SOLUTION:

- ◆ Check that calculations have been corrected appropriately for the relevant variable. In general, calculated saturation values are not as reliable as direct laboratory hemoximeter measurements.
- ◆ If there is excessive light, cover the sensor with opaque material.
- ◆ Circulation distal to the sensor site should be checked routinely. The site must be inspected every 8 hours to ensure adhesion, skin integrity, and correct optical alignment. If skin integrity changes, move the sensor to another site.
- ◆ Try to keep the patient still, or change the sensor site to one with less motion.
- ◆ Observe all instructions, warnings, and cautions in this manual and in the directions for use of the sensor.

PROBLEM: A valid SpO₂ signal was present but has disappeared.

CAUSE:

- ◆ An NIBP determination on the same limb is in progress.

SOLUTION:

Check the patient.

- ◆ An alarm message code appears on the screen, and the audible alarm will sound immediately.
- ◆ Move the sensor to the arm that is not connected to a blood pressure cuff.

11 Alaris Turbo Temp

For your notes

Description

The V100 Monitor uses Alaris Turbo Temp technology (if your monitor has this parameter) and can be used with both oral and rectal temperature probes. The Alaris Turbo Temp parameter consists of an electronic thermometer that uses a temperature-sensing device known as a thermistor. The thermistor is part of the electrical circuit and is located at the tip of the probe. To obtain temperatures, the probe tip measures the rate of change in temperature when the thermistor comes into contact with surrounding tissue. A final temperature is calculated based on this rate of change.

Temperature values are shown in the **Temperature** window in degrees Celsius or Fahrenheit, and the unit of measure is indicated by the °C °F display. The default, which is Fahrenheit, must be changed in the configuration mode. Once in configuration mode, **Unt** (abbreviation for unit) appears in the **Temperature** window; select either °C or °F.

Two modes of operation are available: predictive and monitor.

Predictive Mode

In predictive mode, a final temperature is displayed and an audible single tone sounds. Upon initiation of a measurement, the previous temperature measurement, if present, is cleared. A predictive mode measurement is initiated when the probe is removed from the probe holster. A predictive mode measurement is terminated when one of the following occurs:

- A final value is determined.
- The probe is inserted into the probe holster.
- The temperature measurement mode is automatically switched to monitor mode because a predictive result could not be determined.
- A temperature alarm is issued.

A predictive temperature measurement value is automatically cleared after 2 minutes if the probe is stored in the probe holster or after 5 minutes when the probe is left out of the probe holster.

Monitor Mode

Monitor mode is most commonly used for axillary temperature determinations. In monitor mode, the display is updated continually as the patient's temperature rises or falls. Monitor mode is automatically initiated when the probe is removed from the probe holster twice within a half of a second (remove probe from holster, reinsert probe tip into holster, remove probe from holster) or when a predictive mode measurement terminates after approximately 1 minute of not being able to successfully compute a result. When in monitor mode, the temperature value flashes. When the temperature parameter switches from predictive mode to monitor mode, a tone sounds. Monitor mode is terminated when the probe is inserted into the probe holster.

* Alaris® Turbo Temp® is a trademark of Cardinal Health, Inc.

NOTE: These temperature readings are not stored in history, printed, or reported via host comms.

WARNING

The performance of the monitor may be degraded if it is operated outside of the environmental conditions specified in *Product Overview*.

CAUTIONS

Be careful not to overextend the coiled cord of the temperature probe. Overextension can damage the probe coil connector interfaces.

Accurate oral temperatures can only be obtained by placing the blue probe under the tongue in the right or left sublingual pocket. Temperatures in other locations in the mouth can vary by more than 2°F or 1°C.

Accurate rectal temperatures can only be obtained by using the red temperature probe. Red and blue temperature probes are *not* interchangeable.

Do not allow the tip of the predictive temperature probe to come into contact with a heat source (e.g., hands or fingers) prior to taking a temperature measurement. If this occurs, allow 5 seconds for the probe tip to cool before proceeding.

Use only IVAC probes and P850A probe covers. The size, shape, and thermal characteristics of the probe covers can affect the performance of the instrument. Inaccurate readings may occur unless IVAC probes and probe covers are used.

Electromagnetic Compatibility: Operating the thermometer near equipment which radiates high-energy electromagnetic and radio frequencies (electrosurgical/cauterizing equipment, portable radios, cellular telephones, etc.) may cause false alarm conditions. If this happens, reposition the monitor and temperature probe away from the source of interference and perform a new measurement.

If a patient's temperature is below 96.0°F (35.6°C), the unit will automatically switch from the predictive mode into the monitor mode within 10 seconds. It will continue to monitor the patient's temperature until the probe is removed from the patient and returned to the storage well.

Configuration Settings Associated with Temperature

There is one configuration setting associated with this parameter: Unit of Measure (**Unt**). This setting allows you to choose °Fahrenheit (**F**) or °Celsius (**C**).

Buttons Associated with Temperature

There are no buttons associated with this parameter.

Windows Associated with Temperature

The **Temperature** window displays the value in °C or °F.

Indicators Associated with Temperature

The indicators associated with temperature are °C or °F. When the unit of measure is configured for °C and a probe is connected, the °C indicator is backlit red and the °F indicator is turned off. When the unit of measure is configured for °F and a probe is connected, the °F indicator is backlit red and the °C indicator is turned off. Unless specified otherwise, both indicators are turned off when a probe is not connected.

Measurement in Progress Indicators

Predictive Mode

A single dash appears in the left-side of the **Temperature** window indicating use of an oral probe.



Two dashes appear in the left-side of the **Temperature** window indicating use of a rectal probe.



A “chase sequence” of dashes around the outside of the right-most digit of the **Temperature** window appears indicating that the probe is in contact with skin.



Monitor Mode

The temperature value flashes indicating monitor mode.

Four dashes flash in the **Temperature** window indicating that the measurement is < 80.0°F.



Measurement NOT in Progress Indicators

Two dashes appear in the center of the **Temperature** window indicating no values are present, and the probe is connected.



Blank: The **Temperature** window appears blank indicating that no probe is connected.

User Settings

There are no user settings associated with this parameter.

Menu Settings

There are no menu settings associated with this parameter.

Sounds Associated with Alaris Turbo Temp

There are three sounds associated with the Alaris Turbo Temp parameter.

- Single tone: sounds whenever a temperature probe is removed from or inserted into the probe holster.
- Double tone: sounds whenever monitor mode is activated.
- Triple tone: sounds at the completion of a predictive temperature measurement that results in a final value.

Procedures for Oral Predictive Mode Determinations

For oral temperature measurement, use the blue oral probe.

1. Connect the temperature probe cable to the temperature probe connector.
2. Remove the temperature probe from the probe holster. An audible single-tone sounds. Place a protective temperature probe cover on the probe.
3. Have the patient open his/her mouth and carefully insert the probe tip deep into the sublingual pocket where the richest blood supply is located. Failure to firmly install the probe cover may result in the probe cover becoming loose or disengaged during use. Be careful not to press the probe ejection button where the cord exits the probe as this might loosen or eject the probe cover.

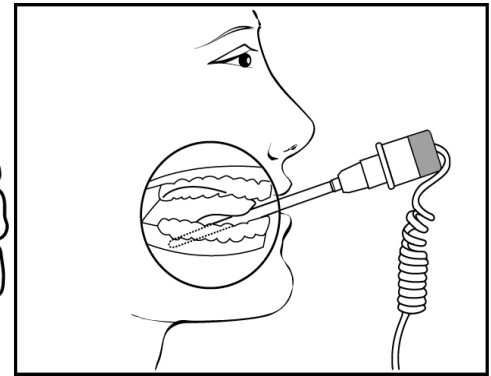
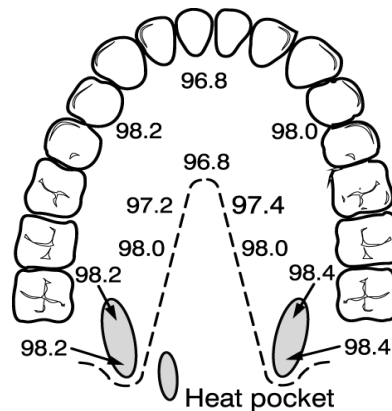

To take an accurate oral temperature reading, place the thermometer tip in either the right or left posterior pocket (heat pocket) at the base of the tongue.

4. Hold the probe steady during the entire temperature measurement process, and keep the probe tip in contact with the tissue at all times. Do not allow the patient to reposition the probe.
5. The determination begins automatically and takes approximately 10 seconds, during which time a "chase sequence" in the right-side of the **Temperature** window appears to indicate progress as well as tissue contact.
6. When the determination is complete, an audible triple tone sounds and the temperature appears on the display.
7. Remove the probe. Discard the disposable cover by holding the probe as you would a syringe and pressing the button on the probe handle. Place the probe in the probe holster. An audible single-tone sounds. Once you place the probe in the probe holster, the temperature values will be cleared in 2 minutes. They are cleared after 5 minutes when the probe is left out of the probe holster.

Procedures for Rectal Predictive Mode Determinations

For rectal temperature measurement use the red rectal probe.

1. Connect the temperature probe cable to the temperature probe connector.
2. Remove the temperature probe from the probe holster. An audible single-tone sounds. Place a protective temperature probe cover on the probe. Failure to firmly install the probe cover may result in the probe cover becoming loose or disengaged during use. Be careful not to press the probe ejection button where the cord exits the probe as this might loosen or eject the probe cover.
3. Touch the tissue about a half inch (1.3 cm) above the sphincter muscle and carefully insert the probe, using current hospital technique for penetration. (The use of a lubricant is optional.)
4. The determination begins automatically. To ensure continuous tissue contact and maximize patient comfort, hold the probe in position until the determination is complete. This takes approximately 10 seconds, during which time a "chase sequence" in the right-side of the **Temperature** window appears to indicate progress as well as tissue contact.

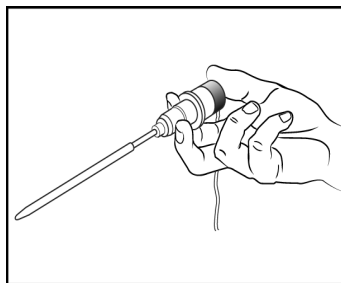

5. When the determination is complete, an audible triple-tone sounds and the temperature appears on the display.
6. Remove the probe. Discard the disposable cover by holding the probe as you would a syringe and pressing the button on the probe

handle. Place the probe in the probe holster. An audible single-tone sounds. Once you place the probe in the probe holster, the temperature values will be cleared in 2 minutes. They are cleared after 5 minutes when the probe is left out of the probe holster.

Procedures for Monitor Mode Determinations (Axillary Determinations)

1. Connect the temperature probe cable to the temperature probe connector.
2. For accurate axillary measurement, the monitor must be set in monitor mode. To trigger monitor mode, remove the probe from the probe holster, then reinsert the probe tip and remove it again within a half of a second (remove probe from holster, reinsert probe tip into holster, remove probe from holster). An audible tone sounds each time you remove the probe from the probe



holster. When monitor mode is activated, an audible double-tone sounds and flashing numbers appear in the **Temperature window**. Place a protective temperature probe cover on the probe and insert the probe in the patient's axilla, making sure the tip of the probe is in contact with the skin and positioned as close as possible to the axillary artery with the patient's arm held close to his/her side.

3. Leave the probe in place for the same length of time as required by standard hospital procedure for taking an axillary temperature. The Monitor does not beep to indicate a final reading.
4. Remove the probe. Discard the disposable cover by holding the probe as you would a syringe and pressing the button on the probe handle. Place the probe in the probe holster. An audible single-tone sounds. Once you place the probe in the probe holster, the temperature values will be cleared immediately.

NOTES

- If there is a long delay from the time the probe is removed from the probe holster until it is inserted into the patient's mouth, it is possible that the instrument will not display a final temperature. If this occurs, insert the probe into the probe holster, remove it again, and start a new measurement.
- If an alarm is actively sounding, temperature-related audible tones will not sound.
- Once the probe is removed from the probe holster and tissue contact is not established within 40 seconds, monitor mode will be entered.
- If the probe tip temperature is 92.0°F (33.3°C) or higher or 60°F (15.6°C) or lower when taken out of the probe holster, the thermometer will not be able to perform a predictive measurement. Instead, the thermometer will automatically go into monitor mode. The temperature reading will then flash. A correct final temperature reading may require 3 minutes or longer. The monitor will not beep at final temperature. It will continue to monitor the patient's temperature until tissue contact is lost and the probe is returned to the probe holster.

Specifications

Specifications	
Scale	°Fahrenheit (F) °Celsius (C)
Range	
Predictive mode	Max: 41.1°C; 106.0°F Min: 35.6°C; 96.0°F
Monitor mode	Max: 41.1°C; 106.0°F Min: 26.7°C; 80.0°F
Monitor mode accuracy	±0.1°C ±0.2°F (when tested in a calibrated liquid bath; meets ASTM E1112, Table 1, in range specified)
Determination time	approx. 10 seconds, typical
<p>NOTE: Use only IVAC probes and P850A probe covers. The size, shape, and thermal characteristics of the probe covers can affect the performance of the instrument. Inaccurate readings or retention problems may occur unless IVAC probes and probe covers are used. Refer to Appendix D for reorder codes.</p>	

Factory Default Settings

Unit of measure: °F

Alaris Patents

U.S. D300,728, D300,909. Other pending patents.

12 Pulse Rate

For your notes

Description

The Pulse Rate parameter is included in all Models. Pulse rate values can be derived from one of two sources. In descending order of priority, they are pulse oximetry (SpO₂) and noninvasive blood pressure (NIBP). The derived values for pulse rate appear in the **Pulse Rate** window.

While SpO₂ is in operate mode, SpO₂ is the primary source of the pulse rate. At any time while SpO₂ is the source and it is unable to publish a value for pulse rate, three dashes (- - -) are displayed in the **Pulse Rate** window.

NOTE: SpO₂ and pulse rate values are filtered by an averaging technique, which determines how quickly the reported values respond to changes in the patient's saturation. Increased averaging time effects time to alarm for SpO₂ saturation and pulse rate limits.

NIBP is the secondary source of pulse rate. Upon completion of a NIBP determination, a pulse rate value is displayed in the **Pulse Rate** window. A pulse rate value is displayed as long as the results of that determination are displayed or until SpO₂ switches to operate mode.

NOTE: When NIBP is in Stat mode and is the source of pulse rate, the pulse rate value is not checked against its limits upon completion of the determination.

When SpO₂ and NIBP are in operate mode, their associated alarms affect their availability to act as the pulse rate source.

NOTES

- Because the various sources measure or derive pulse rate differently from each other, when the monitor changes from one source to another the value in the **Pulse Rate** window may change.
- A patient's vital signs may vary dramatically during the use of cardiovascular agents such as those that raise or lower blood pressure or those that increase or decrease heart rate.
- If an SpO₂-derived pulse rate is erratic, the pulse oximeter parameter may be unable to measure the pulse and may cause an alarm.

Buttons Associated with Pulse Rate

There are no buttons associated with this parameter.

Windows Associated with Pulse Rate

The **Pulse Rate** window displays the pulse rate value in beats per min (bpm).

Indicators Associated with Pulse Rate

The indicators associated with pulse rate are **HIGH** and **LOW**. Refer to “Limit Settings” in this section.

User Settings

Limit settings

There are two limit settings associated with this parameter: **HIGH** and **LOW**. The range for all sources (NIBP and SpO₂) is the same: **HIGH** 35 to 235 bpm and **LOW** is 30 to 230 bpm. The settings appear in increments of 5 bpm.

Upon completion of Stat mode determinations—when NIBP is the source—the pulse rate value is not checked against its limits. The pulse rate value is not checked against user-set limits while the SpO₂ hold-off period is active (refer to SpO₂ hold off period in each “SpO₂” Section).

Menu Settings

If SpO₂ is the source, the **PULSE VOLUME** menu setting is associated with this parameter. This option lets you adjust the volume of the pulse tones that are generated when SpO₂ is the source. It can be adjusted from 0 - 10 (10 being the loudest). If you set the volume to zero, no tone will sound.

Sounds Associated with Pulse Rate

If SpO₂ is the source, there is one sound associated with this parameter: a beat detected sound. A pulse rate tone is indicated by an audible beep each time a beat is detected by the SpO₂ parameter.

NOTE: When the pulse rate is derived from NIBP, there is no audible pulse beat.

Factory Defaults

Pulse rate HIGH alarm limit	150
Pulse rate LOW alarm limit	50

Refer to individual SpO₂ and NIBP sections.

13 Battery

For your notes

Description

The CARESCAPE V100 Vital Signs Monitor uses an internal battery. The battery is a sealed lead acid battery that can be charged at any time without fear of reducing its charge capacity. The monitor is always powered by the battery; and the battery is constantly being charged whenever the external DC charger is connected.

The V100 Monitor is designed to operate from an internal lead-acid battery (see "Specifications" in "Product Overview" Section).

NOTES

- The V100 Monitor is designed to operate with the internal battery in place at all times.
- Be sure to unplug the monitor before transport.

WARNINGS

Do not disassemble, open, or shred the battery under any circumstances.

The battery pack can explode, leak or catch on fire if heated or exposed to fire or high temperatures.

Do not short circuit the battery pack by directly connecting the metal terminals. Be certain that no metal objects such as coins, paper clips, etc., touch the terminals.

Charge the battery pack only with V100 Vital Signs Monitor's internal charger.

Take out the battery pack if storing for long term; overdischarge might impair the battery.

CAUTIONS

During normal charging or discharging no gases are produced by the battery. In the event of a malfunction that causes overheating or overcharging, individual cells may vent gases to minimize accumulation.

Do not drop this battery pack or subject it to mechanical shock.

Use only batteries recommended by GE Medical Systems *Information Technologies*. Other batteries could result in monitor shut down.

Buttons Associated With the Battery

There are no buttons associated with the battery.

Windows Associated With the Battery

There are no windows associated with the battery.

Indicators Associated With the Battery

When the monitor is on, the DC charger is not attached, and the battery is sufficiently charged, the **BATTERY OK** indicator is backlit green. Unless specified otherwise, at all other times this indicator is turned off.

When the **BATTERY LOW** alarm is active as a low-priority alarm, the **BATTERY LOW** indicator is backlit amber and does not flash. When the **BATTERY LOW** alarm is active as a high-priority alarm, the **BATTERY LOW** indicator flashes amber according to the alarm duty cycle for high-priority alarms.

The **CHARGING** indicator is backlit green whenever DC charger is attached to the monitor. Unless specified otherwise, at all other times this indicator is turned off.

NOTE: Refer to "Alarms" Section below for more information.

First Use

To condition a new sealed lead acid battery and optimize its performance, plug in the monitor; the internal battery pack then charges automatically. Before the V100 Monitor is used for the first time, the battery should be charged in the monitor for at least 8 hours. With external DC power connected, the green **CHARGING** indicator will light to indicate that the battery is charging. Prior to first use and after 8 hours of charging, be sure the **BATTERY OK** indicator is backlit green when the charger is not connected and the monitor is on.

Battery Charging

Prior to each use, inspect the power supply cord to ensure proper connection and condition.

With external DC power connected, the green **CHARGING** indicator will light to indicate that the battery is charging. This indicator remains active whether the unit is on or off. An audible "two beep" sounds whenever the DC charger is connected/disconnected.

Battery charging will take place as long as the monitor remains connected to an external DC power source.

- Charge battery pack for 12 hours before first use or after prolonged periods of storage.
- If the monitor is idle for extended periods, it should be fully charged at least once a month to ensure optimum performance.
- The battery pack should be charged before use, because a charged battery loses charge when left in storage. Sealed lead acid batteries can discharge to less than 80% of charge within 60 days of storage. Charging is done automatically by the monitor when the external DC power is connected.
- The battery pack should be charged at room temperature (59°F to 86°F; 16°C to 30°C).
- You can charge or top-off the battery pack at any time. You do not have to wait until battery is fully discharged.
- To prolong the life of the battery, keep the monitor connected to a DC power supply whenever possible. Do not allow the battery to become completely discharged.
- A fully charged battery will power the monitor for approximately 8-11 hours, depending upon configuration and usage.
- To ensure full charge cycles, replace only with a recommended battery.
- If the monitor is to be stored for some time, first charge the battery and then remove it and store it separately from the monitor.

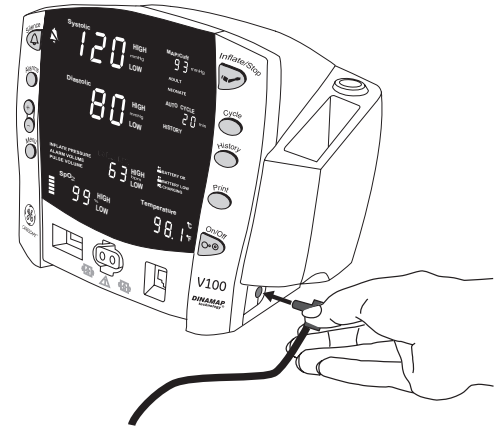

Disposal of Batteries

Refer to Appendix C "Maintenance" for details and disposable batteries.

Storage, Care, and Replacement of Batteries

Refer to Appendix C "Maintenance" for details on disposable batteries.

Alarms

Battery Low

When about 45 minutes of battery charge remains:

The low-priority **BATTERY LOW** alarm is issued.

- ◆ The **BATTERY LOW** indicator illuminates.
- ◆ This alarm can be silenced by pressing the **Silence** button.
- ◆ The **BATTERY LOW** alarm will re-alarm every 10 minutes after it's been silenced.
- ◆ If the alarm is not silenced, the alarm is re-issued every 8 seconds.
- ◆ The monitor continues to operate normally.

When about 5 minutes of battery charge remains:

The low-priority **BATTERY LOW** alarm escalates to a high-priority **BATTERY LOW** alarm.

- ◆ The **BATTERY LOW** indicator flashes.
- ◆ Any NIBP determination in progress at the time of the alarm escalation is allowed to finish.
- ◆ Any Stat mode cycle that was initiated before the alarm escalation is allowed to finish.
- ◆ The user is not able to initiate:
 - ◆ any new NIBP determinations of any type
 - ◆ any printouts

NOTE: At this time, it is highly recommended to plug the monitor into external DC power.

When 5 minutes of battery charge expires:

After 5 minutes of high-priority **BATTERY LOW** alarm, the monitor enters a battery low shutdown.

- ◆ No error code is displayed.
- ◆ The **BATTERY LOW** indicator flashes.
- ◆ The monitor alarms for 2.5 minutes then shuts down completely.

CAUTION

You must plug the monitor into DC power before resuming monitoring.

After plugging the monitor into DC power:

- ◆ The **BATTERY LOW** indicator (when the monitor is on) and **CHARGING** indicator illuminate.
- ◆ The **BATTERY LOW** indicator turns off when the battery level reaches a sufficient charge level to operate without the **BATTERY LOW** alarm active.

E13 Battery Low

At any time while the high-priority **BATTERY LOW** alarm is active, certain actions can trigger the **E13 BATTERY LOW** alarm: any attempt to start an NIBP determination or a printout. This alarm is giving you additional warning that the battery charge is critically low.

NOTE: At this time, it is highly recommended to plug the monitor into external DC power.

- ◆ The **E13** error code appears in the **min** window.
- ◆ The **BATTERY LOW** indicator flashes.
- ◆ This alarm can be silenced by pressing the **Silence** button.
- ◆ The user is not able to initiate:
 - ◆ any new NIBP determinations of any type
 - ◆ any printouts

Specifications

Specifications	
Capacity	6V; 3.3 Ahr sealed lead acid battery
Battery life	8.1 hours (standard deviation of 0.46) with a usage scenario of: NIBP determinations every 15 minutes with SpO ₂ and temperature active. 11.5 hours (standard deviation of 0.53) non-SpO ₂ versions with a usage scenario of: NIBP determinations every 15 minutes with temperature active
Charge time	Approx. 5 hours from full discharge when the monitor is off Approx. 8 hours when the monitor on

Troubleshooting

This section discusses potential difficulties and suggestions for resolving them. If the difficulty persists, contact a qualified service person or your local GE Medical Systems *Information Technologies* representative.

The service manual, which is for use by qualified service personnel, provides additional troubleshooting information.

PROBLEM: The battery does not work or does not last very long.

CAUSE:

- ◆ Has the battery been charged?
- ◆ Has the battery been in storage or a nonuse condition for a few months?
- ◆ Is the battery installed properly?
- ◆ Was the battery over discharged when it was last used?

SOLUTION:

- ◆ New batteries must be charged before use. Refer to *Battery Charging* in this section.
- ◆ Upon first use or when battery has been removed from prolonged storage, you need to charge and discharge your battery up to three times before optimum performance.

PROBLEM: The battery only charged for a short period of time before indicating full charge.

CAUSE:

- ◆ Are you charging the battery for the first time?

SOLUTION:

- ◆ The **BATTERY OK** indicator remains lit as long as there is greater than 45 minutes of battery life. The indicator may light before the battery is fully charged. Charge the battery for the entire period (refer to battery **Specifications**) and then verify that the **BATTERY OK** indicator lights.

PROBLEM: The battery will not charge.

CAUSE:

- ◆ Are you trying to charge the battery in unusually cold or hot temperatures?

SOLUTION:

- ◆ Charging the battery should be done at a basic room temperature of 59°F (16°C) to 86°F (30°C). Slowly bring the battery to the basic room temperature before charging. Batteries can be fully charged only when their internal temperatures are between 57°F (15°C) and 109°F (40°C).

PROBLEM: The **BATTERY LOW** indicator remains lit or flashing.

CAUSE:

- ◆ The battery is unable to recharge.

SOLUTION:

- ◆ The battery needs to be recalibrated or is defective. To recalibrate, simply recharge the battery by plugging the external DC charger into the monitor. The recharge time may vary depending upon the current battery charge status.

A Connections

For your notes

Connection Details

Host Port Connector (rear panel)

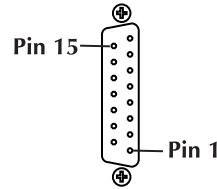

WARNING! Auxiliary equipment connected to the CARESCAPE V100 Monitor will result in the formation of an electromedical system and thus, must comply with the requirements of EN 60601-1-1/ IEC 60601-1. All host port signals are NON-ISOLATED and should be connected to equipment conforming to IEC-60601-1, configured to comply with IEC 60601-1-1 ONLY. Where isolation of data communication is required, GE Medical Systems *Information Technologies* part number ILC1926 should be used. If external alarm control is required, GE Medical Systems *Information Technologies* part number 487208 (Isolated Remote Alarm Cable) should ALWAYS be used along with part number 683235 (Hostcomm Cable Assembly). When a medium- or high-priority alarm condition is displayed on the monitor, the remote alarm signal becomes active within 0.5 seconds. The active state of the alarm signal is an open circuit. In the inactive state the alarm signal is connected to ground. Please refer to the Information Sheet included with the isolated remote alarm cable for operational details.

NOTE: When using remote alarm, the V100 Monitor should be considered the primary alarm source. The secondary alarm is used for secondary purposes only.

Pin #	Function
1	Common
2	Inverted TTL Transmit Data
3	Inverted TTL Receive Data
4	+5 volts
5	No connection
6	No connection
7	Common
8	Remote Alarm
9	No connection
10	No connection
11	RS232 Transmit Data (TxD)
12	No connection
13	RS232 Receive Data (RxD)
14	No connection
15	No connection

B Accessories

For your notes

Accessories

Part	Part description	Part number
NIBP		
NIBP, Adult, 12ft	Air hose adult/ped 12 ft, gray	107365
NIBP, Neonate, 12ft	Air hose, neonatal 12 ft, light blue	107368
NIBP, Adult, 24ft	Air hose adult/ped 24 ft, gray	107366
NIBP, Cuff, Classic Cuff, Neonate	Classic-Cuf, assortment pack, neonatal, 2-tube, M slip	2693
NIBP, Cuff, Classic Cuff, Various	Classic-Cuf, assortment pack, various, 2-tube, screw	2692
NIBP, Cuff, Soft Cuff, Various	Soft-Cuf, assortment pack, various, 2-tube, screw	2695
NIBP, Cuff, Soft Cuff, Neonate	Soft-Cuf, assortment pack, neonatal, 2-tube, M slip	2694
NIBP, Cuff, Dura Cuff, Adult	Dura-Cuf, assortment pack, adult, 2-tube, screw	2698
NIBP, Cuff, Dura Cuff, Child	Dura-Cuf, assortment pack, child, 2-tube, screw	2697
NIBP, Cuff, Dura Cuff, Various	Dura-Cuf, assortment pack, various, 2-tube screw	2699
SpO₂ - Ohmeda		
SpO ₂ - Cable Assy - 3M	OxyTip+ Interconnect cable, Ohmeda, 3 m	OXY-ES3
SpO ₂ - Sensor	Finger Sensor with UN connector, 1 m	OXY-F-UN
SpO ₂ - Sensor	Wrap Sensor with UN connector, 1 m	OXY-W-UN
SpO ₂ - Sensor	Ear Sensor with UN connector, 1 m	OXY-E-UN
SpO ₂ - Sensor	Sensitive Skin Sensor with UN connector, 4 m	OXY-SE-3
SpO ₂ - Sensor	Adult/Pediatric Adhesive Sensor - 25/box	OXY-AP-25
SpO ₂ - Sensor	Adult/Pediatric Adhesive Sensor - 10/box	OXY-AP-10
SpO ₂ - Sensor	AllFit Adhesive Sensor, 0.9 m - 10/box	OXY-AF-10
SpO ₂ - Sensor	Integrated finger sensor, 4 m	OXY-F4-GE
SpO ₂ - Sensor	Integrated ear sensor	OXY-E4-GE
SpO ₂ - Sensor	OxyTip+ Integrated Finger Care connector 2 m	OXY-F2-GE
SpO ₂ - Sensor	OxyTip+ Integrated Ear Care connector 2 m	OXY-E2-GE
SpO ₂ - Accessory	OxyTip+ wide replacement tape, adhesive	OXY-RTW
SpO ₂ - Accessory	Foam wrap replacement, large, weight range ≥ 3 kg	OXY-RWL
SpO ₂ - Accessory	Foam wrap replacement, medium, weight range ≥ 3 kg	OXY-RWM

Accessories: Accessories

Part	Part description	Part number
SpO ₂ - Accessory	Foam wrap replacement, small, weight range < 3 kg	OXY-RWS
SpO ₂ - Accessory	OxyTip+ replacement tape, AllFit Sensor, Bears - 100/box	OXY-RTB
SpO ₂ - Accessory	OxyTip+ replacement tape, AllFit Sensor, Blue - 100/box	OXY-RT
SpO ₂ - Accessory	Infant Foam Sandal, use with OxyTip+ Sensitive Skin sensor - 3/box	OXY-SND
SpO₂ - Nellcor		
SpO ₂ Cable Assy 3M	Cable Assy SpO ₂ Nellcor OxiMax 3 m - Smart	2021406-001
SpO ₂ Cable Assy 3M	Cable Assy SpO ₂ Nellcor OxiMax 1.2 m - Smart	2021406-002
SpO ₂ - Sensor	Max -A Adult Finger Adhesive Sensor - 24/box	70124027
SpO ₂ - Sensor	Max -AL Adult Long Finger Adhesive Sensor - 24/box	2028117-001
SpO ₂ - Sensor	Max-P Pediatric Finger Adhesive Sensor - 24/box	70124022
SpO ₂ - Sensor	Max-N Neonate Foot Adhesive Sensor - 24/box	70124032
SpO ₂ - Sensor	Max-I Infant, Adhesive, Sensor - 24/box	70124026
SpO ₂ - Sensor	Max-R, Adhesive, Nasal - 24/box	407705-005
SpO ₂ - Sensor	OXIBAND (OXI-P/I) Pediatric/Infant Sensor	414248-001
SpO ₂ - Sensor	OXIBAND (OXI-A/N) Adult/Neonate Sensor	414248-002
SpO ₂ - Sensor	OXIBAND (OXI-A/N) Adult/Neonate Sensor	70124035 (EMEA)
SpO ₂ - Sensor	Nellcor Multisite Sensor D-YS Reusable	70124033
SpO ₂ - Sensor	Nellcor DuraSensor DS-100A	70124021
SpO ₂ - Sensor	Nellcor DuraSensor DS-100A	407705-006 (US)
SpO ₂ - Accessory	Nellcor Ear-Clip D-YSE Sensor for 70124033	70124034
SpO ₂ - Accessory	Nellcor Tape ADH-A/N, use with 70124035	2016130-001
SpO ₂ - Accessory	Nellcor Tape ADH-P/I, use with Oxi-P/I Sensors	2016131-001
SpO₂ - Masimo		
SpO ₂ - Sensor	Masimo LNOP Disposable Adhesive Sensor, LNOP Adt. Adult - 20/box	2010458-001
SpO ₂ - Sensor	Masimo LNOP Disposable Adhesive Sensor, LNOP Pdt. Pediatric - 20/box	2010459-001
SpO ₂ - Sensor	Masimo LNOP Disposable Adhesive Sensor, LNOP NeoPT. Neonatal - 20/box	2010461-001

Accessories: Accessories

Part	Part description	Part number
SpO ₂ - Sensor	Masimo LNOP Disposable Adhesive Sensor Bridge, LNOP Neo. Neonatal - 20/box	2010460-001
SpO ₂ - Sensor	Masimo LNOP Disposable Adhesive Sensor, LNOP-Neo-L. Neonatal - 20/box	2017089-001
SpO ₂ - Sensor	Masimo LNOP Disposable Adhesive Sensor, LNOP NeoPT-L. Neonatal - 20/box	2017090-001
SpO ₂ - Sensor	Masimo LNOP Amtx Disposable Adhesive Sensor Transparent Tape LNOP, Adult - 20/box	2027269-001
SpO ₂ - Sensor	Masimo LNOP Pmtx Disposable Adhesive Sensor Transparent Tape LNOP, Pediatric - 20/box	2027270-001
SpO ₂ - Sensor	Masimo LNOP Disposable LNOP Disposable LNOP Hi Fi Sensor Neonatal/Adult - 20/box	2027272-001
SpO ₂ - Sensor	Masimo LNOP Disposable LNOP Disposable LNOP Hi Fi Sensor Infant/Pediatric - 20/box	2027271-001
SpO ₂ - Sensor	Masimo LNOP Disposable LNOP Disposable LNOP Blue Infant Thumb/Toe Sensor - 20/box	2027273-001
SpO ₂ - Sensor	Masimo LNOP Reusable Finger Sensor LNOP/DCIP Pediatric	2002799-001
SpO ₂ - Sensor	Masimo LNOP Reusable Finger Sensor LNOP/DCI Adult, LNOP/DCI	2002800-001
SpO ₂ - Sensor	Masimo LNOP Reusable Multisite Sensor LNOP-YI	2010463-001
SpO ₂ - Sensor	Masimo LNOP Reusable Tip-Clip Ear Sensor LKNOP TC-I	2027274-001
SpO ₂ - Sensor	Masimo LNOP Reusable Finger Sensor Adult DC-195	2009745-001
SpO ₂ - Sensor	Masimo LNCS DCI Reusable Adult Sensor	2027258-001
SpO ₂ - Sensor	Masimo LNCS DCIP Reusable Pediatric Sensor	2027259-001
SpO ₂ - Sensor	Masimo LNCS TC-I TipClip Reusable Ear Sensor	2027261-001
SpO ₂ - Sensor	Masimo LNCS Adult, Transparent Adhesive Sensor - 20/box	2027253-001
SpO ₂ - Sensor	Masimo LNCS Pmtx Pediatric Adhesive Sensor - 20/box	2027254-001
SpO ₂ - Sensor	Masimo LNCS Inf-L Infant Adhesive Sensor - 20/box	2027255-001
SpO ₂ - Sensor	Masimo LNCS Neo-L Neonatal Adhesive Sensor - 20/box	2027256-001
SpO ₂ - Sensor	Masimo LNCS NeoPt-L Neonatal PT Adhesive Sensor - 20/box	2027257-001
SpO ₂ - Cable Assy - 2.4M	Masimo LNOP, SpO ₂ 2.4 m	2017002-003
SpO ₂ - Cable Assy - 3.6M	Masimo LNOP, SpO ₂ 3.6 m	2017002-001
SpO ₂ - Cable Assy - 3M	Masimo LNC-10, SpO ₂ 3 m	2027263-002

Accessories: Accessories

Part	Part description	Part number
SpO ₂ - Accessory	Masimo Replacement Posey Wrap, LNOP-NeoPt-L, Neonatal - 12/box	2010466-001
SpO ₂ - Accessory	Masimo Tape Bag for LNOP-NEO - 100/box	2010467-001
SpO ₂ - Accessory	Masimo Tape Cleanshield Multisite, LNOP-YI - 100/box	2010468-001
SpO ₂ - Accessory	Masimo Disposable Standard Multisite Wrap, Adult/Ped/ Neonatal Adhesive Attachment Wraps, use with LNOP-YI Multisite Reusable Sensor - 100/box	2010469-001
SpO ₂ - Accessory	Masimo Tape Standard Petite Wrap, LNOP-YI - 100/box	2010470-001
SpO ₂ - Accessory	Masimo Adhesive Tape for LNOP-YI - 12/box	2010471-001
Temperature		
Alaris Temperature, Oral Probe	Sensor Turbo Temperature Long, White Cord	2008774-001
Alaris Temperature, Rectal Probe	Sensor Turbo Temperature Long Rectal, White Cord	2008775-001
Alaris Probe Covers	Probe covers - 20/box	615118
Power		
Battery	Battery, Lead-Acid, 6-V, 3.0Ah	633178CR
12W Power Supply	Power supply, Universal, 12W, 100-250VAC, 12VA	2018859-001
Printer		
Replacement Paper	Printer paper roll - 10/box	089100
Mounting Options		
Roll Stand	Rollstand, CARESCAPE, GCX Version	2033297-001
Pole Mount	Pole Mount	2009762-001
Power Supply Mounting Bracket	12W Power supply roll stand bracket	2016929-001
Connectivity		
ILC1931	DINALINK ApexPro Adapter	001931
ILC1926	Isolated Level Convertor	001926
ILC1931	DINALINK ApexPro FH adapter	001932
Cable Assy, use with 001932	Cable assembly to use with 001932	394119-008
Cable Assy, use with 001931	Cable assembly telemetry interface DINALINK	418497-002
Cable Assy, use with 001926, 001931, 001932	Cable assembly, DINAMAP to ILC	683235
Patient ID	Patient ID IR Cable (used with IR adaptor kit)	2024500-001
Patient ID Kit	IR adaptor kit with bracket	2026273-002
Remote Alarm	Remote Alarm Cable	487208CR

Accessories: Accessories

Part	Part description	Part number
Manuals		
Operation Manual - Paper	CARESCAPE V100 Operator's Manual, Hard Copy	2036991-001
Service Manual - Paper	CARESCAPE V100 Service Manual, Hard Copy	2037106-001
Service Manual - CD	CARESCAPE V100 Service Manual, CD	2037107-001

C Maintenance

For your notes

Assistance and Parts

If the product malfunctions or if assistance, service, or spare parts are required, contact GE Medical Systems *Information Technologies* Technical Support. GE Medical Systems *Information Technologies* provides an assembly exchange service. Before contacting GE Medical Systems *Information Technologies*, it is helpful for you to duplicate the problem and check and confirm the operation of all accessories to ensure that they are not the cause of the problem.

WARNING

There are no user-serviceable parts inside the V100 Vital Signs Monitor. Refer all servicing to qualified personnel.

When calling, please have the following information at hand:

- ◆ Product name and model number and complete description of the problem
- ◆ Serial number of your monitor
- ◆ Your name and address
- ◆ Purchase order number if out-of-warranty repairs or spare parts are required
- ◆ Your GE Medical Systems *Information Technologies* account number, if applicable
- ◆ Part number for spare or replacement parts

Maintenance, Calibration, and Cleaning

Discard single-use accessories after use.

Calibration and Leak Testing

Full calibration and leak testing are available in the *CARESCAPE V100 Monitor Service Manual*.

Cleaning

Cleaning the Monitor

CAUTIONS

Never pour or spray water or any cleaning solution on the equipment or permit fluids to run behind switches, into connectors, into the recorder, or into any ventilation openings in the equipment.

Do not let fluid “pool” around connection pins.

CAUTIONS

Never immerse monitor or accessories in any liquid.

Do not attach the monitor or accessories to a patient until it is thoroughly dry.

WARNING

Failure to follow these cleaning recommendations may melt, distort, or dull the finish of displays and cases; blur lettering on labels; embrittle cases and lead to cracks and breakage; or cause equipment failures. Use of non-approved cleaning agents is not considered normal wear and repair or replacement of parts is not covered under warranty.

Monitor Exterior

Disconnect the monitor from AC power before cleaning or disinfecting its surface. The exterior surfaces of CARESCAPE Monitors may be cleaned with a dampened, lint-free cloth. Wipe off all cleaning solutions with a clean, dry cloth and let air dry for at least 15 minutes. Use one of the following approved solutions:

- Mild soap (diluted)
- Commercial diluted bleach solution or bleach wipe
- Commercial diluted ammonia solution
- 10% solution of household bleach (5.25% sodium hypochlorite) in distilled water

Never use the following cleaning agents: –

- Abrasive cleaners or solvents of any kind
- Acetone
- Ketone
- Betadine
- Alcohol- or petroleum-based cleaning agents
- Any type of solution that contains ammonium chloride, conductive solutions, wax or wax compounds
- Sodium salts

NOTE: Never autoclave or steam clean the monitor, cuffs, or accessories.

Monitor Display

To clean the display screen, use a soft, clean cloth dampened with a glass cleaner. Never spray the glass cleaner directly onto the display, and never use alcohol- or petroleum-based products.

Cuff Cleaning and Disinfection

General

The cuff must be thoroughly cleaned with the specified detergent before reuse. The additional use of household bleach as described below provides at least intermediate-level disinfection.

- Apply cuff hose caps before cleaning.
- The following cleansing procedure was repeated 20 times on DURA-CUF Blood Pressure Cuffs and once on SOFT-CUF Blood Pressure Cuffs without affecting the performance of the cuff.
- While this procedure is adequate for cleaning/disinfection, it may not remove all stains.
- Do *not* immerse hoses.
- Do *not* immerse cuffs without prior application of cuff hose caps.

Materials:

- Enzymatic detergent such as ENZOL* enzymatic detergent (US) or Cidezyme* enzymatic detergent (UK)
- Distilled water
- 10% solution of household bleach (5.25% sodium hypochlorite) in distilled water
- Soft cloths and soft-bristled brushes
- Spray bottles

Procedure

1. Prepare the enzymatic detergent according to the manufacturer's instructions and the 10% bleach solution, in separate spray bottles.
2. Spray the detergent liberally on the cuff. If the material is dried on, allow the detergent to set for 1 minute. For soil on the soft part of the closure or the cuff itself, wipe the material off with a soft cloth. For persistent contamination on the soft part of the closure, use a soft-bristled brush to loosen particles. Rinse with copious amounts of distilled water. Repeat until no visible contamination remains. For soil on the hook part of the closure, use a soft-bristled brush to remove the material, and rinse with copious amounts of distilled water. Repeat until no visible contamination remains.
3. Spray the 10% bleach solution on the affected area until the area is saturated. Allow the solution to set for 5 minutes.
4. Wipe away any excess solution and rinse the cuff again with distilled water. Allow 2 hours for drying.

The user has the responsibility to validate any deviations from the recommended method of cleaning and disinfection.

For additional information on infection control procedures, contact GE Medical Systems *Information Technologies* Technical Support.

Temperature Devices

Do not immerse predictive temperature probes. The probe may be cleaned with a solution of 10% bleach in water. Use a cloth or sponge—just damp, not wet—and avoid getting any liquid into the interior of the probe.

SpO₂ Sensors

Adhesive sensors are sterile and for single use only. Reusable sensors should be cleaned before reuse with a 70% alcohol solution. If low-level disinfection is required, use a 1:10 bleach solution. Do not use undiluted bleach (5% - 5.25% sodium chlorite) or any cleaning solution other than those recommended here because permanent damage to the sensor could occur. Do not sterilize the sensor by irradiation, steam, or ethylene oxide. If disposable sensors or their packaging are damaged, they must be disposed of as advised in this appendix.

To clean or disinfect the sensor:

1. Saturate a clean, dry gauze pad with the cleaning solution. Wipe all surfaces of the sensor and cable with this gauze pad.
2. Saturate another clean, dry gauze pad with sterile or distilled water. Wipe all surfaces of the sensor and cable with this gauze pad.
3. Dry the sensor and cable by wiping all surfaces with a clean, dry gauze pad.

Battery and Storage Care

If it becomes necessary to store the monitor for an extended period of time, first fully charge then remove the battery. Then store the monitor and the battery in the original packaging materials.

Batteries should always be fully charged before being placed in storage. Even after 6 months of storage, a fully charged battery can retain about 80% of its charge. A fully charged battery in good condition will provide sufficient power to operate a monitor for approximately 5 hours with a usage scenario of auto NIBP every 5 min with adult cuff, printout after every determination, SpO₂ parameter active at 60 bpm, temperature parameter active in monitor mode.

It is best to keep the battery charged as fully as practical and never store the monitor with the battery in a discharged condition. When the battery will no longer hold a charge, remove and replace it with one of the same part number. Failure to replace the battery with the same GE Medical Systems *Information Technologies* part number may result in shorter battery life.

Battery charging will take place as long as the monitor remains connected to an external DC power source.

A full charge should be performed at least once a month to prevent battery damage.

CAUTIONS

To ensure that the battery will be ready for portable operation, keep the monitor connected to a mains supply whenever possible.

Repeated failure to fully charge the battery will result in a significant reduction in battery life.

The expected lifetime of the battery largely depends on the way in which the monitor is used. If the battery is allowed to completely discharge before being fully recharged, the battery should survive around 450 charge/discharge cycles.

Replacing the Battery

NOTE: Record the configuration settings on your monitor before replacing the battery. When the battery is replaced, all user settings are lost and return to default values.

1. Unplug the monitor from the DC power source.
2. Looking at the bottom of the V100 Monitor, remove the battery compartment cover by removing the four screws that secure the cover and help card tray.
3. Remove the help card tray and battery door cover.

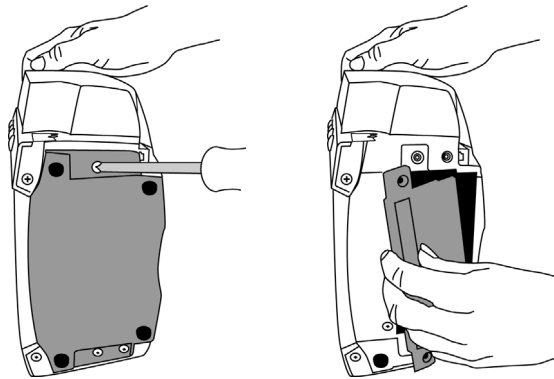

4. Remove the old battery and disconnect the wires. Attach the battery wires to the new battery, ensuring the red terminal (+) is connected to the red wire and the black terminal (-) is connected to the black wire.

5. Insert the battery into the compartment.

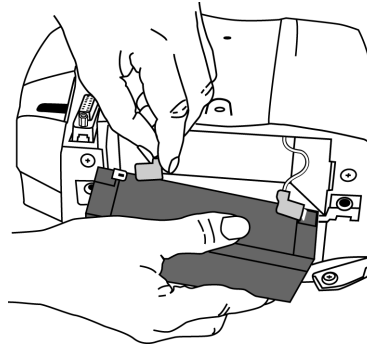

6. Then replace the cover, help card tray, and screws. Insert the external DC power converter plug into the external DC power socket and plug into an AC outlet.

NOTE: Error code **E00** appears (MEMORY LOST) alerting you that the user settings (including alarm limits and inflation pressure) and date/time will go back to default values.

7. Reset the date/time and applicable user settings.

CAUTION

Do not touch either the pin of the DC input connector or the terminals within the battery compartment and the patient at the same time.

Replacement batteries may be obtained from GE Medical Systems *Information Technologies*.

Repairs

If your product requires warranty, extended warranty, or non-warranty repair service, contact GE Medical Systems *Information Technologies* Technical Support or contact your local representative.

Estimates for non-warranty repairs are provided at no charge; however, the product must be sent to GE Medical Systems *Information Technologies* for an estimate. To facilitate prompt service in cases where the product has external chassis or case damage, please advise the representative when you call.

The representative will record all necessary information and will provide a Return Authorization Number. Prior to returning any product for repair, a Return Authorization Number must be obtained.

Packaging Material

Retain original packaging materials for future use in storing or shipping the monitor and accessories. This recommendation includes corrugated shippers and foam/corrugated spacers.

Whenever possible recycle the packaging of accessories and patient applied parts.

Packing Instructions

If you have to return goods for service, follow these recommended packing instructions:

- Remove all hoses, cables, sensors, power cords, and ancillary products from the monitor before packing.
- Wherever possible use the original shipping carton and packing materials.
- Observe the environmental conditions detailed in the Product Overview section of this manual.

It is recommended that all returned goods be insured. Claims for loss or damage to the product must be initiated by the sender.

Disposal of Product Waste

As you use the V100 Monitor, you will accumulate solid wastes that require proper disposal or recycling. These include batteries, patient applied parts, and packaging material.

Batteries

CAUTION

Do not incinerate batteries.

The sealed, rechargeable backup battery contains lead and can be recycled. Do not puncture or place the battery in a trash compactor. Do not incinerate the battery or expose it to fire or high temperatures. Dispose in accordance with regional body controlled guideline.

Patient Applied Parts

Certain patient applied parts, such as those with adhesive (disposable SpO₂ sensors), are intended for single use and should be disposed of properly as medical waste in accordance with regional body controlled guideline.

Other patient applied parts, such as blood pressure cuffs, should be cleaned according to instructions. Inspect reusable applied parts for wear before each use, replace as necessary, and dispose of used product as medical waste in accordance with regional body controlled guideline.

Monitor

At the end of its service life, the product described in this manual, as well as its accessories, must be disposed of in compliance with the guidelines regulating the disposal of such products. If you have questions concerning disposal of the product, please contact GE Medical Systems *Information Technologies* or its representatives.

As you use the V100 Vital Signs Monitor, you will accumulate solid wastes that require proper disposal or recycling. These include batteries, patient applied parts, and packaging material. Dispose of these materials according to local or national regulations.

D Principles of Noninvasive Blood Pressure Determination

For your notes

DINAMAP SuperSTAT Algorithm

The oscillometric method of determining NIBP is accomplished by a sensitive transducer which measures cuff pressure and pressure oscillations within the cuff. For the first determination taken on a patient, the algorithm stores the pattern of the patient's oscillation size as a function of the pressure steps. For subsequent manual, auto, or Stat determinations taken within 2 minutes of a previous determination of the same patient, as few as four pressure steps may be necessary to complete the determination process. In auto mode the data is stored for up to 16 minutes. When employing fewer pressure steps, the system uses the stored information from the previous blood pressure determination to decide the best pressure steps to take. The algorithm measures the consistency of pulse size to tell if the oscillations taken at a step are good and if more steps are needed.

The first determination settles at an initial target pressure of 135 mmHg (adult mode) and 100 mmHg (neonate mode), depending on initial target pressure preset. To allow for rapid settling of cuff pressure, the monitor will momentarily inflate to a higher pressure then immediately deflate to the target pressure. After inflating the cuff, the NIBP parameter begins to deflate. The oscillations versus cuff pressure are measured to determine the mean pressure and calculate the systolic and diastolic pressures.

During an NIBP determination, the parameter deflates the cuff one step each time it detects two pulsations of relatively equal amplitude. The time between deflation steps depends on the frequency of these matched pulses (pulse rate of the patient). However, if the monitor is unable to find any pulse within several seconds, it will deflate to the next step. The process of finding two matched pulses at each step provides artifact rejection due to patient movement and greatly enhances the accuracy of the monitor. The figure shows a full determination sequence for an adult patient. In Stat mode, some steps may require only one pulse.

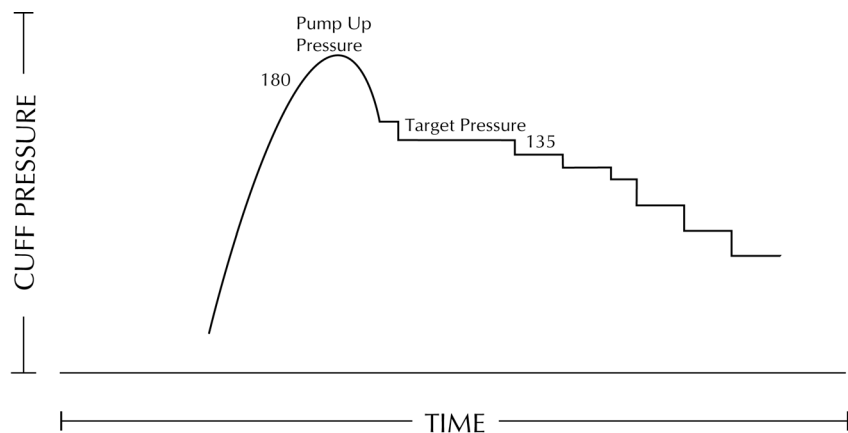

Full NIBP determination sequence for adult

At each step the microprocessor stores cuff pressure, the matched pulse amplitude, and the time between successive pulses. The stepped deflation and matched pulse detection continues until diastolic pressure is determined or total cuff pressure falls below 8 mmHg. The parameter then deflates the cuff (to zero detected pressure), analyzes the stored data, and updates the screen.

The operating cycle is composed of four parts: inflation time, deflation time, evaluation time, and wait time. Wait time, which varies from mode to mode, is affected by the cycle time (auto mode) or operator intervention (manual mode). The figure shows the basic operating cycle for an NIBP determination.

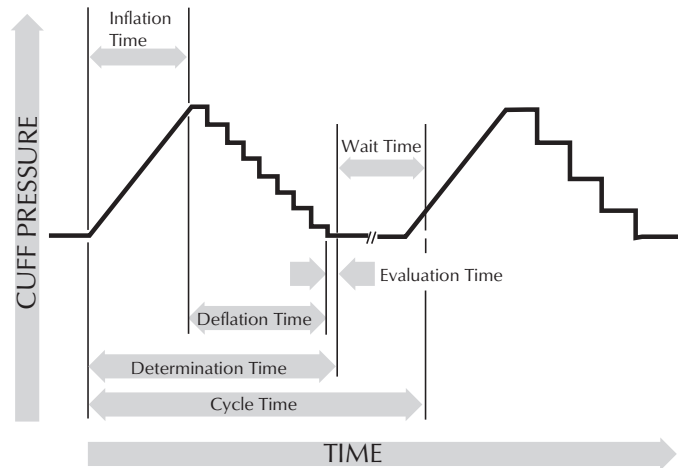

SuperSTAT NIBP - auto mode

Systolic Search

If systolic pressure is not found, the SuperSTAT algorithm can search at cuff pressures higher than the initial target pressure. The algorithm will inflate above the initial target pressure to obtain more data in the systolic region. The pressure is limited to the maximum allowed for the selected patient type.

The SuperSTAT algorithm evaluates the data obtained during the determination, and the prior determination if it is available, to determine if additional data is needed to complete the determination. It can then selectively pump to a single cuff pressure to obtain the data it needs and then return to the existing deflation sequence. This search process makes SuperSTAT more efficient.

Accuracy of the SuperSTAT NIBP measurements was validated against the intra-arterial method. Do not use the auscultatory method to verify the accuracy of the SuperSTAT NIBP parameter. The auscultatory method (using the cuff and stethoscope) determines the systolic and diastolic pressures from sounds that occur during cuff deflation. Mean arterial pressure cannot be determined by this method. The oscillometric method used with all DINAMAP technologies determines systolic, mean and diastolic pressures for the oscillations that occur in the cuff during deflation.

WARNING

Arrhythmias will increase the time required by the NIBP parameter to determine a blood pressure.

DINAMAP Classic and Auscultatory Reference Algorithm

The oscillometric method of determining NIBP is accomplished by a sensitive transducer, which measures cuff pressure and minute pressure oscillations within the cuff. The first determination sequence initially pumps up to a cuff pressure of about 160 mmHg for adult/pediatric patients or 110 mmHg for neonates depending on initial target pressure preset. After inflating the cuff, the monitor begins to deflate it and measures systolic pressure, mean arterial pressure, and diastolic pressure. When the diastolic pressure has been determined, the monitor finishes deflating the cuff and updates the screen.

The monitor deflates the cuff one step each time it detects two pulsations of relatively equal amplitude. The time between deflation steps depends on the frequency of these matched pulses (pulse rate of the patient). However, if the monitor is unable to find any pulse within several seconds, it will deflate to the next step. The process of finding two matched pulses at each step provides artifact rejection due to patient movement and greatly enhances the accuracy of the monitor. The figure shows the NIBP determination sequence.

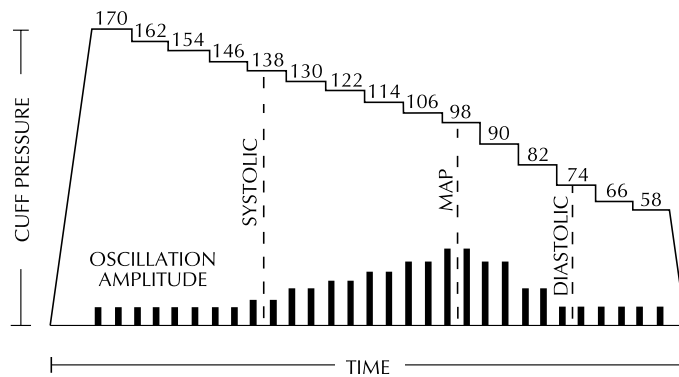

NIBP determination sequence

At each step the microprocessor stores cuff pressure, the matched pulse amplitude, and the time between successive pulses. The stepped deflation and matched pulse detection continues until diastolic pressure is determined or total cuff pressure falls below 7 mmHg. The monitor then deflates the cuff (to zero detected pressure), analyzes the stored data, and updates the screen.

The operating cycle is composed of four parts: inflation time, deflation time, evaluation time, and wait time. Wait time, which varies from mode to mode, is affected by the cycle time (auto mode) or operator intervention (manual mode). The figure shows the basic operating cycle.

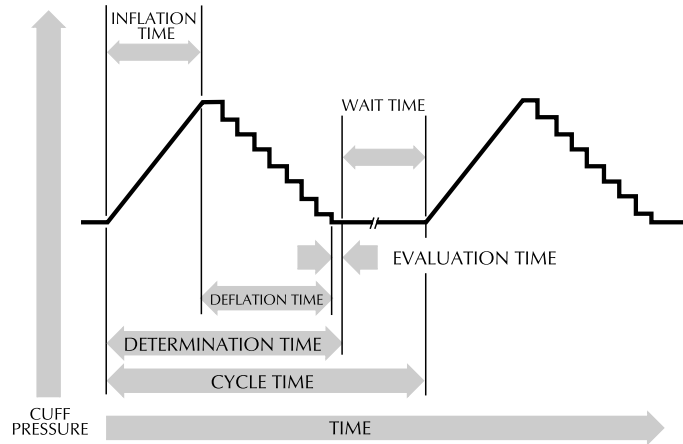

NIBP operating cycle

Systolic Search

If systolic pressure is not found, the NIBP parameter can search at cuff pressures higher than the initial target pressure. The parameter will inflate the cuff above the initial target pressure to get more data in the systolic region. The pressure is limited to the maximum allowed for the selected patient type.

In any operating mode, if a patient's systolic pressure exceeds the inflation pressure of the monitor, the monitor will begin normal deflation sequence, detect the absence of a systolic value, stop deflation, reinflate to a higher (than initial) inflation pressure, and resume normal deflation sequence.

In manual mode, if a previous valid systolic pressure is displayed and less than 2 minutes old, and the new systolic pressure oscillations are compared with the previous valid determination and the monitor "thinks" that the systolic was not obtained, the monitor will inflate the cuff to a pressure above the immediately preceding inflation.

Reference Used to Determine NIBP Accuracy

To establish accuracy of an NIBP device, manufacturers have used several different types of references. The reference blood pressures may be obtained by invasive pressure monitoring at the central aortic region or at the radial sites. The reference blood pressures may also be obtained by noninvasive methods like auscultatory method (using cuff and stethoscope).

NOTE: For neonatal mode, the reference is always the intra-arterial pressure monitoring method.

CARESCAPE V100 Monitors With Intra-Arterial Reference (DINAMAP SuperSTAT and Classic Technology)

For these monitors, the NIBP is referenced to the invasive blood pressure obtained at the central aortic region.

CARESCAPE V100 Monitors With Auscultatory Reference (DINAMAP Auscultatory Reference Technology)

In these monitors, the reference blood pressure is the auscultatory method for adult and pediatric populations. For neonatal populations, the reference is the invasive blood pressure obtained at the central aortic region.

NOTE: For neonatal determinations the SuperSTAT algorithm is always used.

