

Cardinal Health™ Sterilization Pouches

Instructions For Use



Select the compatible pouch according to your sterilization method and the size of the sterilized instrument.

Indications for Use

Cardinal Health™ Paper Sterilization Pouch and Tubing is intended to be used to enclose another medical device, in a single or double pouch configuration, that is to be sterilized by a health care provider using:

- Gravity Steam at 121°C (250°F) for 30 minutes; 25 minute dry time
- Pre-vacuum Steam at 132°C (270°F) for 4 minutes; 20 minute dry time
- Pre-vacuum Steam at 134°C (273°F) for 3 minutes; 20 minute dry time
- Pre-vacuum steam at 135°C (275°F) for 3 minutes; 16 minute dry time
- Ethylene Oxide (EO) with a concentration of 735 mg/L at 55°C (130°F) and 50% to 80% relative humidity for 60 minutes. Aeration time of 8 hours at 60°C (140°F).

The external chemical indicators on the pouch/tubing are intended to demonstrate that the device has been exposed to the Steam or EO sterilization process and to distinguish between processed and unprocessed devices.

Cardinal Health™ Low Temperature Sterilization Pouch and Tubing is intended to be used to enclose another medical device, in a single or double pouch configuration, that is to be sterilized by a health care provider using:

- Ethylene Oxide (EO) with a concentration of 735 mg/L at 55°C (130°F) and 50% to 80% relative humidity for 60 minutes

Cardinal Health™ Sterilization Pouches and Tubing are intended to allow sterilization of the enclosed medical device(s) and also to maintain sterility (SAL=10⁻⁶). The subject device is intended and has been validated to maintain sterility of the enclosed devices for 6 months after steam sterilization and 24 months after EO sterilization, provided package integrity is maintained.

The maximum validated pouch load is 2.64 pounds (1.2kg).

Cardinal Health™ Sterilization Pouches and Tubing are to be used for medical products without lumens.

Directions for Use

Cardinal Health™ Sterilization Pouches and Tubing should be used in accordance with the preparation, packaging and sterilization chamber loading recommendations of the following standards:

- ANSI/AAMI ST79: Comprehensive Guide to Steam Sterilization and Sterility Assurance in Health Care Facilities
- ANSI/AAMI ST41: Ethylene Oxide Sterilization in Health Care Facilities

Packaging

The pouch should only be filled 3/4 of the packing volume to allow proper air evacuation and sterilant penetration. Carefully press the excess air out of the pouch and ensure there is at least one (1) inch of area available around all four (4) sides of the enclosed items.

Sealing

Self-Seal Sterilization Pouch

After removing the protective strip, seal the pouch by folding the adhesive strip onto the pouch. Apply pressure from the center of the adhesive, towards the edges. Repeat this motion an additional time for extra security.

If you are using a double pouching method, the pouch sizes should be selected so the inner pouch can be placed inside the outer pouch without folding. The inner pouch must also be sealed. The paper side of both pouches should face the same way. For example, paper towards paper and film towards film.

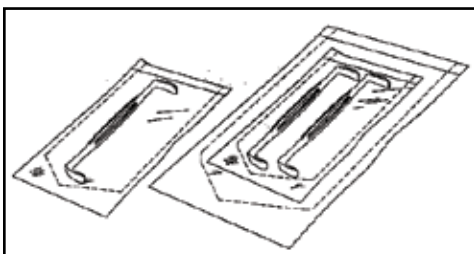

Example of single- and double-packaging with paper-plastic pouches. NOTE: Instruments should be oriented within pouches according to the health care facility's policies and procedures. (Source: ANSI/AAMI ST79: Comprehensive guide to steam sterilization and sterility assurance in health care facilities; Section 8.3.4/Figure 8)

Heat-Seal Sterilization Pouch

Please choose the professional sealing device in order to ensure the stability of the sealing.

For the sterilization tubing products, allow for an opening area along the heat sealed ends of the tubing. The length of the opening area should be ~0.75 to 1.125 in. (~20 to 30mm). If there is any wrinkle in the seal, the pouch cannot be used.

If you are using a double pouching method, the pouch sizes should be selected so the inner pouch can be placed inside the outer pouch without folding. The inner pouch must also be sealed. The paper side of both pouches should face the same way. For example, paper towards paper and film towards film.

Seal the pouch with the heat-seal machine according to the appropriate sealing parameters listed in the chart below.

Recommended sealing parameters – For paper pouch

Sealing Temperature	Pressure	Sealing Time
334°F (168°C) – 383°F (195°C)	0.45 - 0.65 KPa	0.8 - 1.5 seconds

All parameters should be validated before using.

Recommended sealing parameters – For Low Temperature (made from TYVEK®) pouch

Sealing Temperature	Pressure	Sealing Time
257°F (125°C) – 293°F (145°C)	0.45 - 0.65 KPa	0.8 - 1.5 seconds

All parameters should be validated before using.

Loading the Sterilizer

If using several pouches at once, when placing pouches in the sterilizer ensure plastic side of sterilization pouch always faces paper side of adjacent pouch to allow proper air evacuation and sterilant penetration. If possible use a pouch rack to eliminate stacking of the sterilization pouches. Check that pouches are dry upon removal.

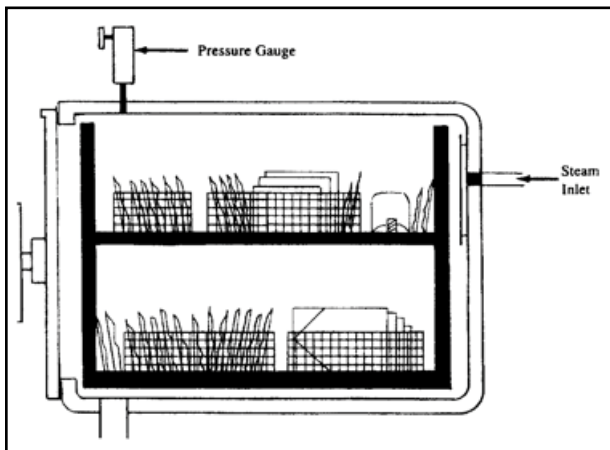

Loading paper-plastic pouches; wire-type baskets to keep the packages in position. (Source: ANSI/AAMI ST79: Comprehensive guide to steam sterilization and sterility assurance in health care facilities; Section 8.5/Figure 9d)

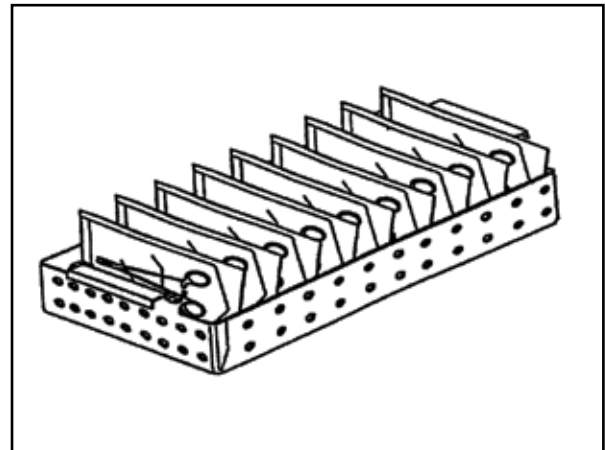

Paper-plastic peel pouches, placed on edge (Source: ANSI/AAMI ST79: Comprehensive guide to steam sterilization and sterility assurance in health care facilities; Section 8.5/Figure 9e)

Sterilization Instructions

1. Please refer to the following recommendations for steam sterilization cycle – paper pouch only.

Sterilizer	Temperature Setting	Exposure Time	Pressure Setting	Drying Time
Steam, gravity cycle	250°F (121°C)	30 minutes	≥ 1.2 bar	25 minutes
Steam, pre-vacuum cycle	270°F (132°C)	4 minutes	≥ 2.1 bar	20 minutes
	273°F (134°C)	3 minutes	≥ 2.1 bar	20 minutes
	275°F (135°C)	3 minutes	≥ 2.1 bar	16 minutes

After steam sterilization, the color of external indicator will change from green to purple.

2. Please refer to the following recommendations for EtO sterilization cycle – paper and low temperature pouch.

Process	Concentration	Temperature Setting	Exposure Time	Relative Humidity (RH)
Ethylene Oxide (EO or EtO)	735 mg/L	130°F (55°, -C)	60 minutes	50% - 80%

After EO sterilization, the color of external indicator will change from yellow to brown.

Opening

Inspect package for damage, moisture, or any sign of potential contamination prior to opening and again after opening but before use of contents.

- Caution: Do not use contents if these conditions are present, as sterility could be compromised. Reprocess the contents using an unprocessed pouch if any of these conditions are noted.
- Open packages aseptically in accordance with the health care facility's policy.

Precaution

The final sterilization result will differ based on the enclosed instrument and position in the sterilizer. Assure that all medical devices intended to be enclosed within the Cardinal Health™ Sterilization Pouches and Tubing are compatible with and indicated for sterilization via the modality and parameters described in the Indications for Use section of these directions. Consult the sterilization instructions from the manufacturer of the device to be sterilized. Note that some devices may require special packing configurations or other sterilization considerations, some of which are described in ANSI/AAMI ST79.

Storage

Storage location should be clean, dust free, and away from fluorescent or ultraviolet light.

Store at room temperature of 59°F (15°C) to 77°F (25°C) and relative humidity (RH) of 40% to 60%.

The shelf life of a properly processed pouch is event related and dependent upon proper handling and storage.

If stored according to the recommended conditions, the products before sterilization have a maximum shelf life of 5 years from the date of manufacture.

Sterility Maintenance

Real-time aging test supports maintenance of package sterility for 6 months after steam sterilization and 24 months after EO sterilization, provided package integrity is maintained.

After sterilization, please use the sterilized instruments immediately. If not used, please store in a cool, dry, ventilated, and non-corrosive gas environment.

Pouch Models Available

The following tables list the available catalog numbers of the Cardinal Health™ Sterilization Pouches and Tubing.



Table 1: Cardinal Health™ Paper Sterilization Pouches and Tubing

Catalog No.	Seal Type	Sterilization Type	Size	Case Configuration
90168	Sterilization Pouch, Heat-Seal	Steam or EO	8 x 16 in.	100/pk, 9 pk/cs
90308	Sterilization Pouch, Heat-Seal	Steam or EO	3 x 8 in.	200/pk, 5 pk/cs
90408	Sterilization Pouch, Heat-Seal	Steam or EO	4 x 8 in.	200/pk, 5 pk/cs
90411	Sterilization Pouch, Heat-Seal	Steam or EO	4.5 x 11 in.	200/pk, 5 pk/cs
90422	Sterilization Pouch, Heat-Seal	Steam or EO	4 x 22 in.	200/pk, 5 pk/cs
90515	Sterilization Pouch, Heat-Seal	Steam or EO	5 x 15 in.	200/pk, 5 pk/cs
90610	Sterilization Pouch, Heat-Seal	Steam or EO	6 x 10 in.	200/pk, 5 pk/cs
90713	Sterilization Pouch, Heat-Seal	Steam or EO	7.5 x 13 in.	200/pk, 5 pk/cs
90810	Sterilization Pouch, Heat-Seal	Steam or EO	8 x 10 in.	200/pk, 5 pk/cs
91015	Sterilization Pouch, Heat-Seal	Steam or EO	10 x 15 in.	100/pk, 5 pk/cs
91218	Sterilization Pouch, Heat-Seal	Steam or EO	12 x 18 in.	100/pk, 5 pk/cs
91315	Sterilization Pouch, Heat-Seal	Steam or EO	13 x 15 in.	100/pk, 5 pk/cs
91616	Sterilization Pouch, Heat-Seal	Steam or EO	16 x 16 in.	100/pk, 5 pk/cs
91822	Sterilization Pouch, Heat-Seal	Steam or EO	18 x 22 in.	100/pk, 5 pk/cs
92028	Sterilization Pouch, Self-Seal	Steam or EO	10.5 x 28 in.	100/pk, 6 pk/cs
92114	Sterilization Pouch, Self-Seal	Steam or EO	4 x 11 in.	200/pk, 4 pk/cs
92152	Sterilization Pouch, Self-Seal	Steam or EO	12 x 15 in.	100/pk, 4 pk/cs
92168	Sterilization Pouch, Self-Seal	Steam or EO	8 x 16 in.	200/pk, 4 pk/cs
92308	Sterilization Pouch, Self-Seal	Steam or EO	3.5 x 8.75 in.	200/pk, 4 pk/cs
92309	Sterilization Pouch, Self-Seal	Steam or EO	3.5 x 9.875 in.	200/pk, 4 pk/cs
92318	Sterilization Pouch, Self-Seal	Steam or EO	13 x 18 in.	100/pk, 4 pk/cs
92322	Sterilization Pouch, Self-Seal	Steam or EO	3.5 x 22 in.	200/pk, 4 pk/cs
92510	Sterilization Pouch, Self-Seal	Steam or EO	5.5 x 10 in.	200/pk, 4 pk/cs
92515	Sterilization Pouch, Self-Seal	Steam or EO	5 x 15 in.	200/pk, 4 pk/cs
92713	Sterilization Pouch, Self-Seal	Steam or EO	7.5 x 13 in.	200/pk, 4 pk/cs
92923	Sterilization Pouch, Self-Seal	Steam or EO	9.125 x 25.5 in.	100/pk, 6 pk/cs
T90002	Sterilization Tubing	Steam or EO	2 in. width, 100 ft. roll	10/cs
T90003	Sterilization Tubing	Steam or EO	3 in. width, 100 ft. roll	10/cs
T90004	Sterilization Tubing	Steam or EO	4 in. width, 100 ft. roll	10/cs
T90006	Sterilization Tubing	Steam or EO	6 in. width, 100 ft. roll	10/cs
T90009	Sterilization Tubing	Steam or EO	9 in. width, 100 ft. roll	6/cs
T90012	Sterilization Tubing	Steam or EO	12 in. width, 100 ft. roll	6/cs

Table 2: Cardinal Health™ Low Temperature Sterilization Pouches and Tubing

Catalog No.	Description	Sterilization Type	Size	Case Configuration
32115	Sterilization Pouch, Self-Seal	E0	10 x 15 in.	100/pk, 5 pk/cs
32218	Sterilization Pouch, Self-Seal	E0	12 x 18 in.	100/pk, 4 pk/cs
32307	Sterilization Pouch, Self-Seal	E0	3 x 7 in.	100/pk, 8 pk/cs
32409	Sterilization Pouch, Self-Seal	E0	4 x 9 in.	100/pk, 8 pk/cs
32412	Sterilization Pouch, Self-Seal	E0	4 x 12 in.	100/pk, 8 pk/cs
32422	Sterilization Pouch, Self-Seal	E0	4 x 22 in.	100/pk, 8 pk/cs
32610	Sterilization Pouch, Self-Seal	E0	6 x 10 in.	100/pk, 8 pk/cs
32812	Sterilization Pouch, Self-Seal	E0	8 x 12 in.	100/pk, 8 pk/cs
37115	Sterilization Pouch, Heat-Seal	E0	10 x 15 in.	100/pk, 5 pk/cs
37218	Sterilization Pouch, Heat-Seal	E0	12 x 18 in.	100/pk, 4 pk/cs
37307	Sterilization Pouch, Heat-Seal	E0	3 x 7 in.	100/pk, 10 pk/cs
37409	Sterilization Pouch, Heat-Seal	E0	4 x 9 in.	100/pk, 10 pk/cs
37412	Sterilization Pouch, Heat-Seal	E0	4 x 12 in.	100/pk, 10 pk/cs
37422	Sterilization Pouch, Heat-Seal	E0	4 x 22 in.	100/pk, 10 pk/cs
37610	Sterilization Pouch, Heat-Seal	E0	6 x 10 in.	100/pk, 10 pk/cs
37812	Sterilization Pouch, Heat-Seal	E0	8 x 12 in.	100/pk, 10 pk/cs
T37003	Sterilization Tubing	E0	3 in. width, 75 ft. roll	10/cs
T37004	Sterilization Tubing	E0	4 in. width, 75 ft. roll	10/cs
T37006	Sterilization Tubing	E0	6 in. width, 75 ft. roll	10/cs
T37009	Sterilization Tubing	E0	9 in. width, 75 ft. roll	6/cs

Translation of Symbols

Symbol	Definition
	Product reference number / catalog number
	Lot number
	Use by: year and month



NON STERILE



SINGLE USE ONLY



NOT MADE WITH NATURAL RUBBER LATEX



KEEP DRY

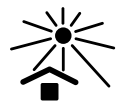

AVOID DIRECT SUNLIGHT

Distributed by:
Cardinal Health
 3651 Birchwood Drive
 Waukegan, IL 60085 USA
 Rev. G 2018-08
cardinalhealth.com
 Made in China
 36-6545



© 2018 Cardinal Health. All rights reserved. CARDINAL HEALTH and the Cardinal Health logo are trademarks of Cardinal Health and may be registered in the US and/or in other countries. All other marks are the property of their respective owners.