



Scan the QR Code with your Phone camera to watch product videos on the NOVA Youtube Channel 

300 Series Transport Chair User Guide

For models: 309, 319, 327, 329, 330, 332, 349, 352, 379



CARE • QUALITY • INNOVATION



THE NOVA PROMISE

CONTACT US!
We're here to help

 info@novajoy.com

 1 800 557 6682

novajoy.com

Revised on September 15, 2020

User Guide

NOVA Transport Chair

300 Series

OWNER

YOU MUST READ THIS MANUAL BEFORE USING THIS PRODUCT

DEALER

YOU MUST SUPPLY THE OWNER WITH THIS MANUAL

WARNINGS

User weight not to exceed 300 lbs. (Model #s 309/319/327/329/330/349/352/379)

User weight not to exceed 400 lbs. (Model # 332)

ALWAYS operate the chair with the back support in the upright locked position.

ALWAYS secure the user to the chair using the seat belt.

ALWAYS ensure that all grips and textured surfaces are secure before pushing, pulling, or placing weight on such surfaces.

ALWAYS perform the initial product inspection and all follow-up inspections before using the product.

ALWAYS engage the wheel locks upon entering or leaving the transport chair.

ALWAYS test the push handles to make sure that both push pins are securely in place before sitting in the chair.

DO NOT allow user to enter or exit chair without caregiver standing behind the chair with a secure grip on both handles.

DO NOT operate this transport chair on streets or roadways.

DO NOT stand on or put pressure on footrests when entering or exiting the transport chair.

DO NOT use the wheel locks to slow your descent down an incline.

DO NOT change directions when going down an incline. This may cause instability.

DO NOT scoot on or operate the chair without an assistant maintaining a secure grip from behind the chair.

DO NOT sit on chair unless the product is fully open and in its normal usable position.

DO NOT use ramps or operate the product on inclines greater than 9 degrees of slope.

DO NOT operate on stairs, moving walkways, escalators, roads, streets, or highways (Use extreme caution when operating product in crowded areas or outdoors).

DO NOT operate the chair in bad weather or when ground conditions may impair traction, such as ground with water, oil, ice, gravel, or any other slippery or unstable substance.

DO NOT attempt to cross curbs, bumps, trenches, or other uneven surfaces. Doing so may tip over the product. Operate product only on smooth well-maintained surfaces.

DO NOT attempt to reach objects while using product as this requires you to move your weight and can cause the product to tip over.

DO NOT reach for objects, as this requires you to move your weight, and can cause the product to tip over.

DO NOT pick up objects from the floor, as this requires you to move your weight, and can cause the product to tip over.

DO NOT tilt the transport chair while occupied.

DO NOT use the wheel locks as brakes, nor attempt to stop a moving product by engaging the wheel locks.

DO NOT attempt to lift the product by pulling on any removable part or surface.

DO NOT stand on the product, the product frame, or any other part of the product.

DO NOT use the footrests as a platform. When attempting to enter or exit the product, ensure that the footrests are in the upward, unusable position.

DO NOT carry heavy weight while occupying the product. The product is not designed for additional weight and is not balanced to accommodate additional weight.

DO NOT lift weights or exercise while occupying the product.

This transport chair has not been approved as a seat surface to be used within a vehicle. Transport chair must be on a level surface when transferring user to or from seat. Footrests should be no less than 2 1/2 inches from the floor/surface.

COMMON PART LOCATIONS



To Unfold

1. Remove chair from the box and place it on the ground. Remove any cardboard protection and the plastic from the wheels. (We recommend turning the box on the side and "rolling" out the Transport Chair).
2. Bring the folding push handles upward fully to enlarge and lock the push pins into the frame of the chair.
3. Place both hands on the upholstery just to the inside of the seat tubes and push down and out until the seat is fully opened. Your fingers could be pinched, therefore, be sure both hands and all fingers are flat on the upholstery. Do not allow fingers to grab or reach the black tubes that secure the seat. Continue to push down and outward until tubes engage into the seat supports. Please call NOVA customer service if you have any questions.)

To Fold

1. Pull upward on the middle of the seat from the front and rear until the chair is completely folded.
2. Release and fold down the back/push handles by pushing down on the release paddle and allowing the handles to come down into a folded position.

To Attach the Footrests

1. First determine the left and right side by folding down the footplate and placing them in front of the seat. The foot plates should be facing each other and directly in front of the seat.
2. Place the attachment plates with holes above the pins and slowly lower the holes onto both pins.
3. Swivel the footrests inward until the silver release lever engages and locks the footrest into the forward position.

To Remove the Footrests

1. Push the silver release lever inward to release the footrests from the forward position.
2. Swivel outward and lift the footrests from the footrest pegs.

To Adjust the Footrest Height For Models 307/319:

1. Locate tool wrench included with the footrests.
2. Turn wheels so they are in the "wheeled" position (as pictured).
3. Use the tool wrench to slightly loosen the silver hex screw located on the bottom of the footrests by turning the screw left.
4. Pull on the footplate to desired length. Footrests should be a minimum of 2 1/2" from the ground to ensure proper clearance.
5. Re-tighten the hex screw.
6. Repeat on other side.

For Models 327/329/330/332/352:

1. Remove height adjustment knob by turning counter clockwise.
2. Adjust the inner tube to desired height and line up hole on inner telescoping tube with outer hole.
3. Screw adjustment knob back into the adjustment leg and tighten.

To Use Hand Brakes (Models 330/332/352)

The hand brake is to be used for speed control only. Squeeze up on the hand brake to control the speed. Use the wheel brake when entering or exiting the chair.

Engage the Park Brake

Push down on the handle located at the rear of the hand brake. The handle will lock into a downward position when properly engaged. Pull up on the handle to release the brakes.

How to Adjust the Brakes

Note: The braking system on your new Transport Chair with Hand Brakes has been preset from the factory. If you need to adjust the tension of your brakes, you can adjust them by the following:

Hand Brake is Too Loose.

Loosen the tension adjustment screw locking nut and turn the screw one full turn clockwise (as viewed from standing at the back of the transport chair). If this does not correct the adjustment, repeat one full turn at a time until you have adjusted your brakes. Then make sure the locking nut is spun tight against the housing to prevent the screw from loosening.

Hand brake is Too Tight.

Same as the procedure above except turn the screw counter clockwise.

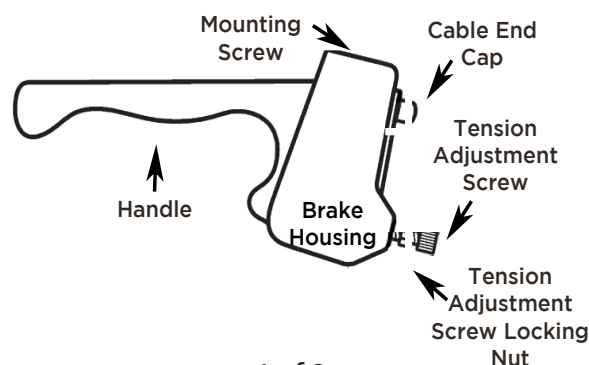

USER INSTRUCTIONS

To Sit Down

1. Engage the rear wheel locks so that the wheels by pushing down on the brake handle until the brake shoe presses firmly on the wheel and prevents the chair from rolling.
2. Flip the footrests into an upright position so that the user can stand between the footrests with the back of their legs touching the seat upholstery.
3. From behind the chair assist the user by slowly lowering them into the chair.

To Rise from Seated Position

1. Engage the rear wheel locks so that the wheels by pushing down on the brake handle until the brake shoe presses firmly on the wheel and prevents the chair from rolling.
2. Flip both footrests into an upright position.
3. Place both feet firmly on the ground and rise slowly from the chair with the assistance of a care giver.

To Transfer from Seated Position (Model #s 352/332)

1. Place the chair alongside of the desired seating device.
2. Engage the rear wheel locks so that the wheels by pushing down on the brake handle until the brake shoe presses firmly on the wheel and prevents the chair from rolling.
3. Remove or flip back the arm on the side of the transfer by pressing on the plastic covers located on the front and rear of the arm.
4. Release the footrests and swing them to the outer sides of the chair frame or flip both footplates upward to a vertical position.
5. Carefully transfer from the chair to desired seating area with the assistance of a caregiver.

OPERATING INSTRUCTIONS

SERVICE

All service must be performed while the transport chair is unoccupied.

Minor adjustments may be attempted by an able-bodied individual. All minor adjustments that one should attempt are detailed in the manual. Do not attempt any adjustment or repair without reading and understanding the instructions in this manual. Do not attempt any adjustment or repair that is not detailed in this manual. Any adjustment or repair not detailed in this manual should only be performed by a dealer or licensed technician.

Individuals with muscular or balance problems should not attempt to make adjustments to the product, and are advised to seek assistance.

After any adjustment, and before using the product, ensure that all attaching hardware, including without limitation all grips, screws, nuts, bolts, clamps, fasteners, and parts are tight and secure.

DO NOT use parts, accessories, or adapters other than those manufactured by NOVA Medical Products, Inc, which are designed specifically for this product.

SAFETY INSPECTION - MAINTENANCE

Your product is a precision product - proper care will ensure proper function. Regular cleaning will reveal loose or worn parts. **DO NOT** over tighten parts or hardware, as doing so can damage the frame. **DO NOT** operate the product if there are any missing parts or hardware. You should have a dealer or qualified professional perform maintenance on your product at least once every six months, or immediately if you notice any item needing service. Frequent use likely means that your product will require more maintenance than we suggest. In anticipation of and after any excessive use, we recommend that you perform a complete safety inspection including all items.

ITEM	INSPECT ITEM	INITIAL	WEEKLY	MONTHLY	6 MONTHS
GENERAL	Transport chair should roll straight, doesn't feel "tight" or pull to one side	X	X		
	Inspect for loose, missing, or broken hardware in all locations	X		X	
	Inspect cane hand grips for wear, looseness, or deterioration	X			X
FRAME	Inspect for bent frame	X		X	
	Inspect weld points for cracks, chips, or loose material	X			X
CROSS-BRACES	Inspect for bent cross-braces	X		X	
	Inspect weld points for cracks, chips, or loose material	X			X
BRAKES	Ensure brakes do not interfere with wheels when rolling	X	X		
	Pivot points free of wear and looseness	X		X	
	Brakes are easy to engage, and engage fully	X	X		
	Brakes prevent transport chair from moving when engaged.	X	X		
SEAT AND BACK	Inspect upholstery for rips or sagging	X			X
	Inspect for loose or broken hardware	X		X	
WHEELS	Lift, spin, and check for side movement, rubbing, or binding	X		X	
	inspect the rubber wheels have sufficient tread and brakes can be engaged	X			
	Inspect for cracks and wear (hubs and rims)	X		X	
	Inspect for cracked or broken spokes	X			X
HAND RIMS	Inspect for signs of rough edges or peeling	X		X	
FRONT FORKS	Inspect wheel/fork assembly for proper tension by spinning caster. Caster should come to a gradual stop, and not bind or grind	X		X	
	Adjust bearing system if wheel wobbles noticeably or binds to a stop	X		X	
	Ensure wheel bearings are clean and free of debris	X			X
	Check swivel fork locknuts for tightness	X		X	
CLEANING	Clean upholstery and arm rests	X	X		

Transport Chair Information

Item Number: _____

Serial Number: _____

Date Purchase: _____

The item and serial number are located on a sticker that is attached to the frame under the seat (**see below sample**).

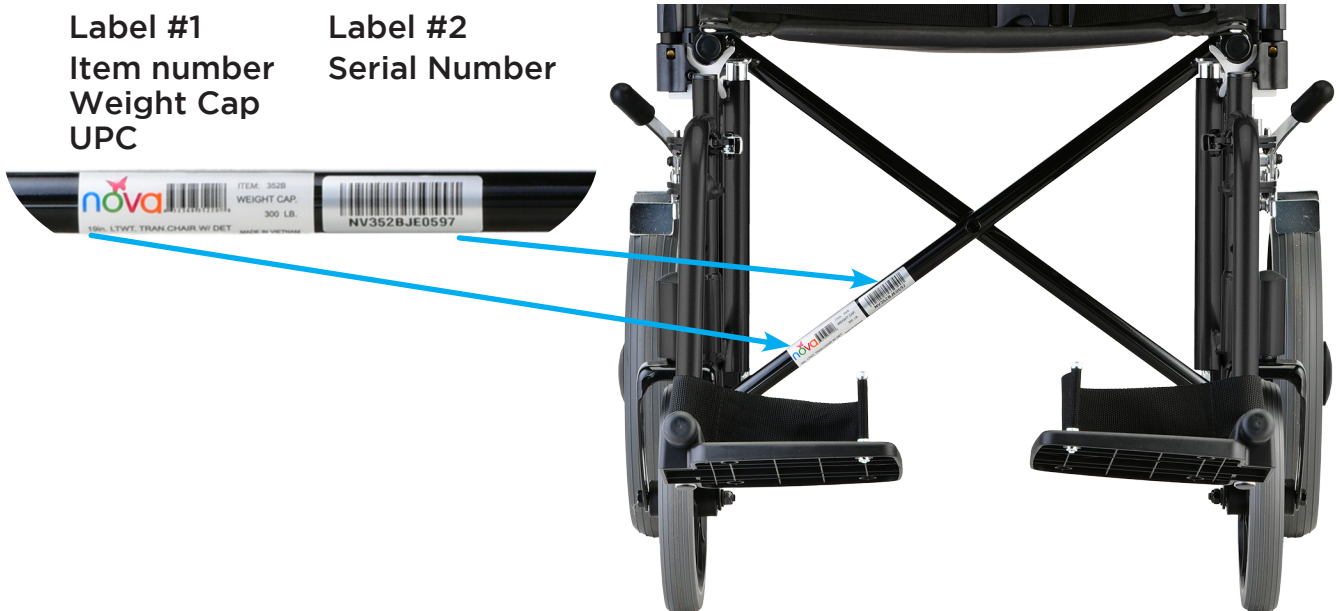

Warranty Information

NOVA stands firm on our commitment to providing the highest quality products, as well as exceptional service. This product was built to precise standards and thoroughly inspected prior to shipment. This warranty represents our confidence in the materials and workmanship of our product. NOVA extends this warranty only to the original purchaser of this product. The warranty does not extend to any subsequent purchaser or owner. The warranty is void upon any sale or transfer of ownership or use by other person. NOVA warrants its products are free from defects in material and workmanship under NORMAL use for the period commencing upon the date of purchase and continuing for the following specified period of time after that date:

Metal frame: *Limited Lifetime Warranty*
Brakes: *5 Years*
Non-Metal/Metal parts: *1 Year Limited Warranty*
(Wheels, Hand Grips, Padding, Cables, Upholstery, Bag, Screws, Plastic Parts)

This warranty does not cover problems due to user negligence, misuse of the product, failure to adhere to product instructions, or normal wear and tear. Items that have been subject to negligent abuse, modified without prior written authorization are not covered within this warranty. For warranty service, please contact the dealer from whom you purchased your NOVA product. In the event that you do not receive satisfactory service, please call us directly at the number below. Be prepared to indicate, the nature of the defect, the product serial number, and the name and location of where you purchased the product. You will also be required to provide a receipt of your purchase. DO NOT return any products to our office without prior consent. Repair or replacement is the only remedy under this limited warranty. This warranty does not include any labor or shipping charges incurred in replacement part installation or repair of product.

THIS WARRANTY IS EXCLUSIVE AND IN LIEU OF ALL OTHER EXPRESS WARRANTIES, IMPLIED WARRANTIES, IF ANY, INCLUDING THE IMPLIED WARRANTIES OF MERCHANTABILITY AND FITNESS FOR A PARTICULAR PURPOSE. NOVA SHALL NOT BE LIABLE FOR ANY SEQUENTIAL OR INCIDENTAL DAMAGES WHATSOEVER.

*****Remember to keep the product's serial number and the date of purchase*****

IMPORTANT WARNING
FOLLOW ALL DIRECTIONS CAREFULLY BEFORE USE. FAILURE TO DO SO MAY RESULT IN SERIOUS INJURY.



CARE • QUALITY • INNOVATION



THE NOVA PROMISE

SINCE 1993

NOVA believes in the power of joy. We are guided by joy, and inspired by our customers who **choose joy** everyday and every step of the way.

novajoy.com



WARNING!

Cancer and Reproductive Harm -
www.P65Warnings.ca.gov

CONTACT US!
We're here to help





 info@novajoy.com

 1 800 557 6682

novajoy.com

Connect with us!

novajoy.com

 [novamedicalprod](https://www.facebook.com/novamedicalprod)
 [novamedicalprod](https://twitter.com/novamedicalprod)
 [novawalkerstalk](https://twitter.com/novawalkerstalk)
 [NOVA Medical Products](https://www.youtube.com/NOVAMedicalProducts)