

Invacare® Carroll CS Series™

CS3, CS5, CS7, CS9FX600

en Beds
User Manual



This manual **MUST** be given to the user of the product.
BEFORE using this product, read this manual and save for future reference.



Yes, you can.®

©2018 Invacare Corporation

All rights reserved. Republication, duplication or modification in whole or in part is prohibited without prior written permission from Invacare. Trademarks are identified by ™ and ®. All trademarks are owned by or licensed to Invacare Corporation or its subsidiaries unless otherwise noted.

Sherwin-Williams® is a registered trademark of Sherwin-Williams.

Making Life's Experiences Possible is a registered trademark in the U.S.A.

Contents

1 General	4
1.1 Intended Use	4
1.2 Symbols	4
2 Overview	7
2.1 Product Labeling	7
2.2 Specifications	9
2.3 Mattress Specifications	14
2.4 Operating Conditions	14
3 Safety	15
3.1 General Guidelines	15
3.2 EMI Information	24
3.3 Electromagnetic Compatibility Information	25
3.4 Disposal	25
4 Set-up	26
4.1 Receiving	26
4.2 Unpacking	26
4.3 Inspecting	29
4.4 Installing the Mattress Keeper Rod	30
4.5 Installing the Head and Foot Ends	33
4.6 Storing the Bed	36
5 Operation	37
5.1 Pendant Operation	37
5.2 Pendant Storage and Location	38
5.3 Power Cord Storage	41
5.4 Raise and Lower the Heel Lift Ratchet	42
5.5 Foot Pad Lock Mechanism	43
5.6 Bed Steer Mechanism	44
6 Optional Accessories	45
6.1 Bed Rails and Positioning Devices	45
6.2 Other Accessories	48

6.3 Optional Touch-up Paint	48
6.4 Optional Attendant Control Panel Operation	48
6.5 Optional Pendant HI/LO Lock Out	49
6.6 Optional 39 Inch and 42 Inch Wide Decks	50
6.7 Adjustable Width Bed Model CS9FX600	50
6.7.1 Adjusting the CS9FX600 Bed Width	50
6.7.2 Adjusting the Head Board Width for CS9FX600	53
7 Maintenance	54
7.1 Cleaning	54
7.2 Annual Maintenance Check	55
7.3 Quarterly Maintenance Check	55
8 Troubleshooting	56
8.1 Troubleshooting	56
9 Warranty	59
9.1 Limited Warranty	59

1 General

1.1 Intended Use

The bed is intended to be used as a mattress support system. The bed allows for articulation of the head and foot sections to provide different positions for the patient. It is intended to be used in home care and long term care facilities.

1.2 Symbols

Signal words are used in this manual and apply to hazards or unsafe practices which could result in personal injury or property damage. See the information below for definitions of the signal words.



DANGER!

– Danger indicates an imminently hazardous situation which, if not avoided, will result in death or serious injury.



WARNING!

– Warning indicates a potentially hazardous situation which, if not avoided, could result in death or serious injury.









CAUTION!











– Caution indicates a potentially hazardous situation which, if not avoided, may result in property damage or minor injury or both.









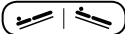

Gives useful tips, recommendations and information for efficient, trouble-free use.

Symbols Used on the CS Bed

	Protective Conductor Terminal
	Equipotentiality
	Warning – Safe Working Load The Maximum allowable load on equipment if the instructions for installation and use are followed.
	Alternating Current
	ON – Supply
	OFF – Supply
IPX4	International Protection Code (04 – Protection against water spray from any direction)
	Applied part Type B Equipment
CLASS I	Equipment classification in terms of protection against electrical shock

	Intertek's ETL Listed Mark for US and Canada. A product bearing the ETL Listed Mark is determined to have met the minimum requirements of prescribed product safety standards.
	Battery Charging (Yellow)
	Battery Fully Charged (Green)
	Recycle this product. Refer to <i>3.4 Disposal</i> , page 25.
	Lift with Two Persons (based on ISO 3864)
	Function Lock-Out Activate toggle switch to deny function access on the hand pendant.
	Initiate action to the entire mattress support platform (HILO)
	Initiate action to head section of mattress support platform
	Toggle switch for one-touch head and knee-foot raise operation
	Initiate action to the knee-foot section of the mattress support platform

	<p>Up Control – Raise the corresponding section of the mattress support platform.</p> <p>Down Control – Lower the corresponding section of the mattress support platform.</p>
	<p>Trendelenburg and Reverse Trendelenburg functions</p>
	<p>General warning symbol (ISO 3864)</p>
	<p>Danger: electricity, electrical hazard symbol (IEC 61310, ISO 3864)</p>
	<p>Explosive material, explosion hazard symbol (IEC 61310)</p>
	<p>Flammable material symbol (IEC 61310)</p>
	<p>Crush hazard symbol (based on ANSI Z535)</p>
	<p>Crush hazard symbol (based on ANSI Z535)</p>

	<p>Crush hazard symbol (based on ANSI Z535)</p>
	<p>Drop/Fall Hazard symbol (based on IEC 61310)</p>

2 Overview

2.1 Product Labeling

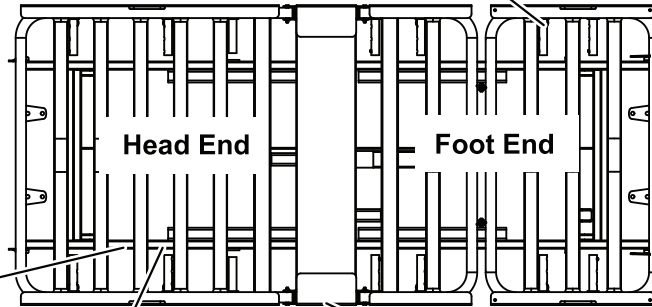

<p>AVERTISSEMENT</p> <p>Un patient peut être blessé ou même mourir s'il est coincé. Les huit sections de plateformes ajustables DOIVENT être de même largeur : 36, 37,5 ou 42 cm. Pour l'utilisation d'une tête de lit avec le modèle CS9FX600, vous devez utiliser la tête de lit réglable de modèle IHBEADJ. La tête de lit doit être de même largeur que le lit. Suivez les instructions du fabricant pour le réglage du lit et de la tête de lit. Le matelas doit s'adapter à l'encadrement et aux longs pans et s'adapter correctement aux dispositifs pour éviter le coincement du patient. Il est important de lire et de comprendre le manuel de l'utilisateur avant d'utiliser cet équipement. Vous trouverez les manuels ICCI sur le site www.invacare-cc.com ou chez votre détaillant.</p>		<p>WARNING</p> <p>Patient entrapment may cause injury or death. All eight adjustable deck sections MUST be set to the same width: 36 in, 39 in or 42 in. If using a head board with the CS9FX600 model bed, an adjustable head board, model IHBEADJ, must be used. Headboard must be set for the same width as the bed. Follow the manufacturer's instructions for adjusting bed and head board. The Invacare mattress must fit firmly against the bed frame and side rails and assist devices to prevent patient entrapment. Read and understand the User Manual prior to using this equipment. ICCI manuals are available at www.invacare-cc.com or your dealer.</p> <p style="text-align: right; font-size: small;">Part No. 1158522 Rev. C</p>
---	---	--

On Both Sides of CS9FX600 Bed



Serial Number Label

ETL Label - 120V (CS3, CS5, CS7, CS9FX600)
ETL Label - (CS5, CS7)

<p>AVERTISSEMENT</p> <p>Risque d'écrasement occasionné par la ZONE DE MARGE FAIBLE DU LIT. Éloignez-vous de l'encadrement et assurez-vous qu'aucun enfant ou animal ne se trouve sous ou près de l'encadrement du lit avant de l'abaisser. Faites attention aux POINTS DE PINCEMENT situés sous les panneaux, près des fixations d'accessoires et entre les pièces mobiles.</p>	 	<p>WARNING</p> <p>Crush Hazard due to LOW BED CLEARANCE. Stay clear of frame and ensure children and pets are not under or near the frame before lowering the bed. Beware of PINCH POINTS below deck panels, next to fixed attachments and between moving parts.</p> <p style="text-align: right; font-size: small;">1158522 Rev. A</p>
--	--	--

On Both Sides of Bed



All labels applied to bed frame except where noted.

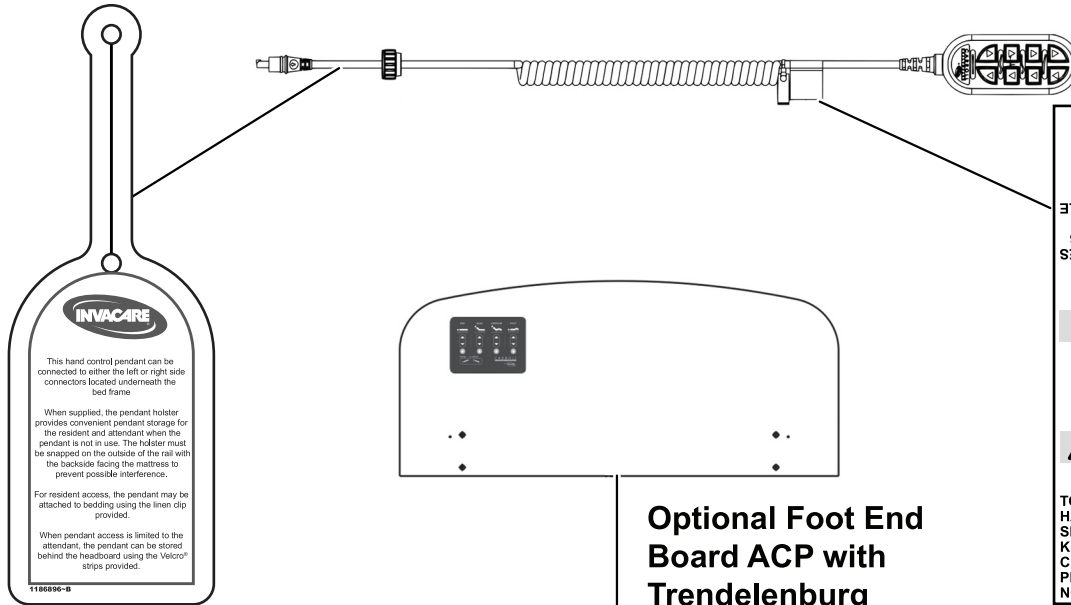

This hand control pendant can be connected to either the left or right side connectors located underneath the bed frame.

When supplied, the pendant holster provides convenient pendant storage for the resident and attendant when the pendant is not in use. The holster must be snapped on the outside of the rail with the backside facing the mattress to prevent possible interference.

For resident access, the pendant may be attached to bedding using the linen clip provided.

When pendant access is limited to the attendant, the pendant can be stored behind the headboard using the Velcro® strips provided.

1186896-B

Optional Foot End Board ACP with Trendelenburg

1183513-B

SERT PAS. SUPPORT LORSQU'IL NE LAISSEZ-LE DANS SON DES PIÈCES MOBILES ET TEUR HORS DE PORTEE CORDON DU COMMUTA- ENDOMMAGES: GARDEZ LE CORDONS EMMÊLES OU DE CHUTE, AINSI QUE DES POUR EVITER LES RISQUES DOMMAGES LÉGERES OU DE RISQUE DE BLESSURES

CAUTION

CAUTION
RISK OF MINOR INJURY OR DAMAGE
TO AVOID TRIPPING HAZARD OR PINCHED OR SEVERED CORDS: KEEP SWITCH CORD CLEAR OF MOVING PARTS. PLACE IN HOLDER WHEN NOT IN USE.

1183513-B

AVERTISSEMENT

Risque d'écrasement lors de l'utilisation de Trendelenberg Inversée. Un point de pincement existe entre le pied de lit et la terre à la position plus basse. L'abaissement du pied de lit peut causer des blessures à soi-même ou à autrui. Ne PAS placer les pieds, jambes ou bras dans la zone d'écrasement située sous le pied de lit. Se reporter au Manuel d'utilisation avant d'utiliser le lit.



WARNING

Crush hazard when using Reverse Trendelenburg. Pinch point exists between the footboard and the floor at the lowest bed position. Lowering the foot may cause INJURY to oneself or others. DO NOT place feet or limbs in the crush zone located beneath the rail. Refer to the product manual prior to operating the bed.

P/N 1156582 Rev B

2.2 Specifications

Certifications

All models (120 V~ models - CS3, CS5, CS7, CS9FX600 and 230 V~ models - CS5, CS7) conform to UL60601-1 and IEC60601-1. Certified to IEC60601-2-38 and IEC60601-1-2 and CAN/CSA C22.2 No. 601.1. 230 V~ models - CS5 and CS7 are CE marked for Australia and New Zealand.

Elevation Range (floor to deck)

	CS3	CS5	CS7	CS9FX600
Stability Range (casters locked or off casters)	8¼ to 26½ in (210 to 673 mm)	9 to 30 in (229 to 762 mm)	7 to 30 in (178 to 762 mm)	9 to 30 in (229 to 762 mm)
Mobility range (on casters)	8¼ in (210 mm) only			
Angle between back section (head deck) and deck platform	0° to 70°			
Angle between back section and upper leg section	>90°			
Trendelenburg or reverse trendelenburg (when configured)	not available		0° to 14° (Optional)	
Under-bed clearance for 2/3 of bed - centered	14 in (356 mm)			

Electrical Specifications

	CS3	CS5	CS7	CS9FX600
Control box mains voltage	120V~	120V~ or 230V~	120V~ or 230V~	120V~
Control box input current	3.5A max	3.5A max (1.5A max for 200V~ models)	3.5A max (1.5A max for 230V~ models)	3.5A max
Control box current frequency	60 Hz	60 Hz (50 Hz for 230 V models)	60 Hz (50 Hz for 230 V models)	60 Hz
Control box output voltage	24 VDC (70W max)			
Control box duty cycle	10% Max (2 min ON 18 min OFF)			
Motorized linear head actuator	24 Volts DC			
Motorized linear actuators (head, foot, and HI/LO)	24 Volts DC			
Six button hand pendant	standard		not available	
Eight button hand pendant with contour function	not available		standard (10 button optional)	
Attendant control panel (ACP)	optional			
Trendelenburg ACP	not available		optional	

Safety Features

	CS3	CS5	CS7	CS9FX600
Protective earth ground	Class I			
Electric shock protection	Type B			
Enclosure protection	IPX4			
Floor lock	not available	Optional	standard	
Built-in battery back-up	not available		optional (standard with Trendelenburg 24V DC 9.2 Amps)	

Security - Pendant Lock-Out

	CS3	CS5	CS7	CS9FX600
Pendant connection from either side of bed	standard			
ACL (attendant control lock-out) pendant HI/LO function lock-out	optional			
Individual pendant function lock-out on ACP	optional			

Dimensions and Weight

	CS3	CS5	CS7	CS9FX600
Length (overall) 76 in and 80 in CS Beds 80 in CS Bed with 4 in Extension		84¼ in (2140 mm) 88¼ in (2242 mm)		
Length between head and foot ends 76 in CS Bed 80 in CS Bed 80 in CS Bed with 4 in Extension		78½ in (1994 mm) 82½ in (2096 mm) 86½ in (2197 mm)		
Length, mattress platform 76 in CS Bed 80 in CS Bed 80 in CS Bed with 4 in Extension		76 in (1930 mm) 80 in (2032 mm) 84 in (2134 mm)		
Width, mattress platform 36 in Standard Deck 39 in Wide Deck 42 in Wide Deck		35½ in (901 mm) 38½ in (978 mm) 41½ in (1054 mm)		

Dimensions and Weight

	CS3	CS5	CS7	CS9FX600
Width with assist rails - 36 in standard deck	39¼ in (997 mm)			
Width with Thinksoft® positioning devices				
36 in Standard	41¼ in (1048 mm)			
39 in Wide	44¼ in (1124 mm)			
42 in Wide	47¼ in (1200 mm)			
Weight				
36 in Standard Deck	186 lb (84 kg)	190 lb (86 kg)		not available
39 in Wide Deck	196 lb (89 kg)	200 lb (91 kg)		not available
42 in Wide Deck	199 lb (90 kg)	203 lb (92 kg)		not available
CS9FX600 Adjustable Deck	not available	not available		206 lb
Load capacity - safe working load	450 lb (204 kg)	500 lb (227 kg)		600 lb (272 kg)
84 in bed length extension	optional			
39 in or 42 wide bed deck	optional Not compatible with 68 inch rail.			not available
Adjustable Deck	Not Available			Standard Not compatible with 68 inch rail

2.3 Mattress Specifications

The mattresses in this table have been tested to comply with FDA Entrapment Guidelines when sold new and unused, and used as part of a system with new and unused CS Series beds and rails:

Model Number	Weight
IXL1076	30.0 lbs (13.6 kg)
IXL1080	31.0 lbs (14.1 kg)
IXL1084	35.0 lbs (15.9 kg)
IPM1076	31.0 lbs (14.1 kg)
IPM1080	32.0 lbs (14.5 kg)
IPM1084	34.0 lbs (15.4 kg)
IPM1080B39	37.0 lbs (16.8 kg)
IPM1080B42	37.5 lbs (17.0 kg)
SRS2076	30.0 lbs (13.6 kg)
SRS2080	30.0 lbs (13.6 kg)
SRS2084	30.0 lbs (13.6 kg)
SRS2084RSR	30.0 lbs (13.6 kg)
SRS2080W39	30.0 lbs (13.6 kg)
SRS2080W42	25.0 lbs (11.3 kg)
SPS1080	21.0 lbs (9.5 kg)
SPS1080RSR	32.0 lbs (14.5 kg)

Model Number	Weight
SPS1084	24.0 lbs (10.9 kg)
microAir Series*	17 – 56 lbs (7.7 – 25.4 kg) varies depending on model
SKS1080	20.0 lbs (9.1 kg)
SKS1084	22.0 lbs (10.0 kg)



*The microAir series of air mattresses are excluded from the FDA Entrapment Guidelines tests.

2.4 Operating Conditions

Recommended Storage and Shipping Temperature	14°F to 125°F (-10°C to 50°C)
Recommended Operating Temperature	41°F to 100°F (5°C to 40°C)

3 Safety

3.1 General Guidelines



DANGER!

Risk of Death, Injury or Damage

Improper use of this product may cause injury or damage.

- If you are unable to understand the warnings, cautions or instructions, contact a healthcare professional, dealer or technical personnel before attempting to use this equipment.
- Do not use this product or any available optional equipment without first completely reading and understanding these instructions and any additional instructional material such as user manuals, service manuals or instruction sheets supplied with this product or optional equipment.

Continued use of the product with damaged parts could lead to the product malfunctioning, causing injury to the user and/or caregiver.

- Check ALL product components and carton for damage, and test components before use. DO NOT use product if components are damaged or if product is not working properly. Contact a qualified technician or Invacare for repair.

To avoid injury or product damage:

- Set-up and Assembly instructions MUST be performed by qualified technicians only. “Qualified Technician Only” sections are marked accordingly.



DANGER!

Risk of Death, Injury or Damage

Lighted cigarettes can cause a fire or other related hazards resulting in death, injury or damage.

- Do not smoke while using this product.
- Do not allow others to smoke near this product.



DANGER!

Risk of Death, Injury or Damage

Bed accessories designed by other manufacturers have NOT been tested by Invacare. Use of Non-Invacare bed accessories may result in injury or death.

- Use ONLY Invacare rails, mattresses, bed extenders and other accessories with Invacare bed products.



THE INFORMATION CONTAINED IN THIS DOCUMENT IS SUBJECT TO CHANGE WITHOUT NOTICE.



DANGER!

Risk of Death, Injury or Damage

Improper assembly may cause injury or damage. Use of incorrect or improper parts, including replacement (service) parts, may cause injury or damage.

- Replacement parts MUST match original Invacare parts.



DANGER!

Risk of Injury or Death

To reduce the risk of electrical shock:

- Always unplug the product from the electrical outlet before cleaning.



DANGER!

Risk of Death, Injury or Damage

To reduce the risk of shock:

- Unplug from the outlet before servicing.
- Close supervision is necessary when the product is used by, or near children and/or disabled persons.
- Use this product only for its intended use as described in these instructions. **DO NOT** use attachments not recommended by the manufacturer.
- If liquid is spilled in or around the product, unplug before cleaning. Clean up the spill and allow the product or the area around the product to dry thoroughly before using the controls again.



DANGER!

Risk of Death, Injury or Damage

To avoid shock, product damage and personal injury:

- **DO NOT** use outdoors.
- Connect this product to a properly grounded outlet only. Refer to Operation.
- **DO NOT** place video equipment such as televisions or computer monitors on product.



DANGER!

Risk of Death, Injury or Damage

To avoid injury or damage when operating product:

- After any adjustments, repair or service and before use, make sure all attaching hardware is tightened securely.
- Close supervision is necessary when the product is used near children or pets OR when this product is operated by or near people with physical/mental disabilities. Physically challenged individuals who cannot prevent themselves from rolling/climbing out of the product may require alternative safe means of restraint.
- The product is not designed to be used as a patient transport. When transporting a patient, use an approved patient transport. Otherwise, injury or damage may result.

**WARNING!****Risk of Injury or Damage**

To avoid injury or damage when operating/moving bed:

- ALWAYS ensure that the individual utilizing the bed is positioned properly within the confines of the bed. DO NOT let any extremities protrude over the side or between the bed rails when performing these functions.
- Be aware of potential pinch points when operating bed, rails or other accessories.
- The bed is equipped with locking casters. Before using the bed, test the wheel locks to ensure casters lock correctly. When transferring into or out of the bed, ALWAYS lock the casters. Even with casters properly locked, some flooring surfaces (such as tile or wood) will allow the bed to move under some conditions. Using the bed on these types of surfaces MUST be evaluated by the care provider. DO NOT transfer occupant if bed is not stable. Otherwise, injury and/or damage may occur.
- DO NOT move product with locking casters in LOCKED position.

**DANGER!****Risk of Death, Injury or Damage**

To avoid pinching, crush and collapse hazards from bed deck contact with objects under the bed:

- DO NOT place any object or let any individual underneath the bed or in between the raised bed frame components at any time.

To avoid risk of death or injury from choking or ingestion of small parts or materials:

- Closely supervise children, pets or individuals with physical/mental disabilities.



Refer to the **Bed Rail Entrapment Risk Notification Guide** at www.invacare.com for additional safety information.



DANGER!

Risk of Death, Injury or Damage

Patient entrapment from the use of bed side rails may cause injury or death. To avoid patient entrapment:

- The Invacare mattress **MUST** fit firmly against the bed frame **AND** bed side rails to prevent patient entrapment. Follow the manufacturer’s instructions. Monitor patient frequently. Read and understand the user manual prior to using the Invacare bed and bed rails. User manuals are available at www.invacare.com or your dealer.
- After any adjustments, repair or service and before use, make sure all attaching hardware is tightened securely.



DANGER!

Risk of Death, Injury or Damage

Conditions such as restlessness, mental deterioration and dementia or seizure disorders (uncontrolled body movement), sleeping problems, and incontinence can significantly impact a patient's risk of entrapment. Pediatric patients or patients with small body size may also have an increased risk of entrapment.

- Monitor patients with these conditions frequently.
- Place the mattress deck in the flat position when left unattended.



WARNING!

Risk of Injury or Adverse Health Consequences

Fall hazard exists due to bed height.

- Always leave bed in lowest height when unattended.
- For the CS3 bed only: Place the bed in the lowest position possible without disengaging the foot pad lock mechanism.

Replacement Parts/Accessories



DANGER!

Risk of Death, Injury or Damage

To avoid fire hazards and tubing entanglement:

- Use masked or nasal type oxygen administering equipment only in conjunction with the manual/electric bed. The use of any other type of oxygen administering equipment can result in a fire hazard.
- When using nasal or masked type oxygen administering equipment, the oxygen or air tubing **MUST** be routed and secured properly to ensure that the tubing does not become entangled and/or severed during normal operation of the manual/electric bed.
- Do not use this bed in Active Treatment “Ether Environments.”

**DANGER!****Risk of Death, Injury or Damage**

To avoid fire hazards, injury or damage:

- DO NOT use product with flammable gases. Explosion may occur.

**WARNING!****Risk of Injury or Damage**

To avoid injury or damage from misuse or entrapment:

- Read and understand the instructions or label provided with mattress.
- If you do not understand the instructions or if instructions are missing, contact the mattress manufacturer.

**DANGER!****Risk of Death, Injury or Damage**

To avoid entrapment, product damage, and/or personal injury:

- Invacare recommends that the mattress be centered on the bed frame. Otherwise, individuals may become trapped between the bed rail and the bed frame.
- ALWAYS test to make sure that the side rails are properly and securely in place before using. Otherwise, injury or damage may occur.

**DANGER!****Risk of Death, Injury or Adverse Health Consequences**

Fall hazard exists due to incorrect installation of bed rails.

- To avoid injury, ensure that the Invacare bed rails are installed correctly and securely attached to the bed while entering or exiting.

Fall hazard exists due to use of Non-Invacare bed rails. Non-Invacare bed rails are potentially incompatible with Invacare beds.

- To avoid injury, ensure that only Invacare bed rails are used with Invacare beds at all times.

Fall hazard exists due to use of Non-Invacare mattresses. Non-Invacare mattresses are potentially incompatible with Invacare beds.

- To avoid injury, ensure that only Invacare mattresses are used with Invacare beds at all times.

**DANGER!****Risk of Death or Injury**

An increased risk of patient entrapment may occur over time due to mattress compression.

- Periodically monitor gaps between the bed, mattress and/or bed rail. Where gaps occur, patient entrapment is possible and the mattress should be replaced.



DANGER!

Risk of Death, Injury or Damage

To avoid entrapment, product damage and/or personal injury:

- When used with a bed, the bed rails DO NOT fall under any weight limitations. Bed rails can be deformed or broken if excessive side pressure is exerted on the bed rails. These bed rails are used for the purpose of preventing an individual from inadvertently rolling out of bed. The bed rails are not intended nor may be used for restraint purposes. If an individual is capable of injuring himself/herself, a physician or a healthcare professional should be consulted for alternative means of restraint.
- After raising/lowering the head/foot end of the bed, check the distance between the bottom of the bed rail and the mattress. If there is excessive distance between the bottom of the bed rail and the mattress in which individuals may become entangled, adjust the height of the bed rail (if applicable), or provide alternative means of patient protection.
- DO NOT use the side rails as push handles for moving the bed.
- Replacement mattresses and bed side rails with dimensions different from the original equipment supplied or specified by the bed frame manufacturer are not interchangeable. Variations in bed side rail design, width and thickness or firmness of the mattress could cause/contribute to entrapment.



DANGER!

Risk of Death, Injury or Damage

To avoid injury or damage from misuse or entrapment:

- Proper patient assessment and monitoring, and proper maintenance and use of equipment is required to reduce the risk of entrapment. Variations in bed rail dimensions and mattress thickness, size or density could increase the risk of entrapment. Visit the FDA website at <http://www.fda.gov> to learn about the risks of entrapment. Review “A Guide to Bed Safety”, published by the Hospital Bed Safety Workgroup. Use the link located under each bed rail product entry to access this bed safety guide.
- Refer to the user manuals for beds and rails for additional product and safety information.
- Patient entrapment from the use of bed side rails may cause injury or death. The Invacare mattress MUST fit firmly against the bed frame AND bed side rails to prevent patient entrapment. Follow the manufacturer’s instructions. Monitor patient frequently. Read and understand the User Manual prior to using this equipment. Invacare manuals are available at www.invacare.com or your dealer.
- An increased risk of patient entrapment may occur over time due to mattress compression. Periodically monitor gaps between the bed, mattress, and/or bed rail. Where gaps occur, patient entrapment is possible and the mattress should be replaced.

Electrical



WARNING!

Risk of Death, Injury or Damage

Shock hazards and risk of fire exist due to use of improper extension cord and use of three prong adapters.

- To avoid injury or product damage, when using an extension cord, use only a UL approved three prong extensions cord having at least 16 AWG (American Wire Gauge) wire and the same or higher electrical rating as the product being connected.
- DO NOT use three prong to two prong adapters.



WARNING!

Risk of Injury or Damage

To avoid product damage and personal injury:

- Disconnect pendant when not in use and store out of reach of children.

Grounding Information



WARNING!

Risk of Shock Injury

Electric beds are equipped with three prong (grounding) plugs for protection against possible shock hazards. Where a two prong wall receptacle is encountered, it is the personal responsibility and obligation of the customer to contact a qualified electrician and have the two prong receptacle replaced with a properly grounded three prong wall receptacle in accordance with the National Electrical Code.

- If you must use an extension cord, use only a three prong extension cord having the same or higher electrical rating as the product being connected. DO NOT, under any circumstances, cut or remove the round grounding prong from any plug used with or for Invacare products.



WARNING!

Risk of Injury or Damage

To avoid injury or damage from improper grounding or using damaged parts:

- DO NOT operate the product if the cord or outlet is damaged.
- DO NOT operate the product if any motor has malfunctioned or is damaged in any manner.

Weight Limitations



DANGER!

Risk of Death, Injury or Damage

To avoid bed collapse and resulting injury or damage:

- The weight limit of the occupant of the bed CANNOT exceed 600 lbs (272 kg) for model CS9FX600, 500 lbs. (228 kg) for models CS5 and CS7, and 450 lbs. (204 kg) for model CS3. The TOTAL weight limit of the bed (including accessories, mattress, occupant and any other objects positioned on the bed) cannot exceed rated capacity or Safe Working Load.
- NEVER permit more than one individual on the bed at any time.
- Body weight should be evenly distributed over the surface of the bed. DO NOT lay, sit or lean in such a way that your entire body weight is placed only on raised head or foot sections of the bed. This includes when repositioning or transferring in or out of bed.
- Each of the preceding impacts can permanently damage either HI/LO motor resulting in an inoperable bed. In the case of an inoperable bed due to a damaged HI/LO motor, the HI/LO motor must be replaced immediately. If left unattended, a damaged HI/LO motor can cause the bed to fall from the highest extended position, resulting in patient injury. DO NOT exceed the maximum continuous duty cycle. Refer to 2.2 *Specifications, page 9*.

Operating Information



DANGER!

Risk of Death, Injury or Damage

To avoid serious injury or product damage from tripping, strangulation, entanglement and/or pinched, or severed cords:

- Ensure that all cord(s) are routed and secured properly.
- Keep all moving parts, including the main frame, mattress deck, and all drive shafts, free of obstruction (i.e. blankets/sheets, tubing, wiring, cords, etc.) during operation of the product.
- Do not roll the product over the power or pendant cord.
- Use the Power Cord Strap when moving the bed. Refer to 5.2 *Pendant Storage and Location, page 38* and 5.3 *Power Cord Storage, page 41*.

**WARNING!****Risk of Product Damage**

To avoid product damage:

- DO NOT open assemblies such as the motors, pendant or junction boxes. No user serviceable parts are inside. Contact dealer or Invacare for repair/replacement.
- Ensure control box cover and all other assemblies are closed.
- Unplug the power cord from its power source before performing any maintenance on the product. DO NOT unplug the power cord from the junction box. Damage to cord will result.

**CAUTION!****Risk of Product Damage**

Mis-alignment of cable connections will cause permanent product damage.

- To avoid product damage, all electric cable connections MUST be aligned properly. Align locking levers with locking tabs for proper connection.
- DO NOT force the connector into the control box.

**DANGER!****Risk of Death, Injury or Damage**

In the event of a power outage, the bed can be powered by its internal battery (the internal battery is optional for the CS7 and CS9FX600 models and standard on the CS9FX600 with Trendelenburg). To avoid injury, damage or death from controller malfunction or electrocution:

- The bed must remain plugged into the grounded outlet for proper grounding when powered by the internal battery.
- Charge battery through the controller. NEVER attempt to charge the battery by any other means.
- Internal battery, if present, should be tested monthly.

**DANGER!****Risk of Death, Injury or Damage**

To avoid product damage and/or personal injury from fall or entrapment:

- Invacare recommends the use of mattress keepers.

3.2 EMI Information



CAUTION!

Risk of Damage

To avoid product damage from electromagnetic interference:

- It is very important that you read this information regarding the possible effects of electromagnetic interference on this product.

This product may be susceptible to electromagnetic interference (EMI), which is interfering electromagnetic energy (EM) emitted from sources such as radio stations, TV stations, amateur radio (HAM) transmitters, two way radios, and cellular phones. The interference (from radio wave sources) can cause the powered bed to release its brakes, move by itself, or move in unintended directions. It can also permanently damage the powered bed's control system. The intensity of the interfering EM energy can be measured in volts per meter (V/m). Each powered bed can resist EMI up to a certain intensity. This is called its "immunity level." The higher the immunity level, the greater the protection. At this time, current technology is capable of achieving at least a 20 V/m immunity level, which would provide useful protection from the more common sources of radiated EMI.

There are a number of sources of relatively intense electromagnetic fields in the everyday environment. Some of these sources are obvious and easy to avoid. Others are not apparent and exposure is unavoidable. However, we believe that by following the warnings listed below, your risk to EMI will be minimized.

The sources of radiated EMI can be broadly classified into three types:

1. Handheld Portable transceivers (transmitters/receivers with the antenna mounted directly on the transmitting unit. Examples include: citizens band (CB) radios, "walkie talkie", security, fire and police transceivers, cellular telephones, and other personal communication devices).



Some cellular telephones and similar devices transmit signals while they are ON, even when not being used.

2. Medium range mobile transceivers, such as those used in police cars, fire trucks, ambulances and taxis. These usually have the antenna mounted on the outside of the vehicle; and
3. Long range transmitters and transceivers, such as commercial broadcast transmitters (radio and TV broadcast antenna towers) and amateur (HAM) radios.



Other types of handheld devices, such as cordless phones, laptop computers, AM/FM radios, TV sets, CD players, cassette players, and small appliances, such as electric shavers and hair dryers, so far as we know, are not likely to cause EMI problems to this product.

3.3 Electromagnetic Compatibility Information



Portable and mobile RF communications equipment can affect medical electrical equipment.



WARNING!

Risk of Product Damage

The use of accessories, transducers, cords and cables other than those specified by the manufacturer, may result in increased emissions or decreased immunity of this bed.

- This product should not be used adjacent to or stacked with other equipment. If adjacent or stacked use is necessary, this product should be observed to verify normal operation in the configuration in which it will be used.

3.4 Disposal

Follow local governing ordinances and recycling plans regarding disposal of the product or components normally used in operation. The product does not generate waste or residue in operation. Any accessories not part of the product **MUST** be handled in accordance with the individual product marking for disposal.

This product has been supplied from an environmentally aware manufacturer that complies with the Waste Electrical and Electronic Equipment (WEEE) Directive 2012/19/EC.

This product may contain substances that could be harmful to the environment if disposed of in places (landfills) that are not appropriate according to legislation.

Please be environmentally responsible and recycle this product through your recycling facility at its end of life.

4 Set-up

4.1 Receiving



WARNING!

Risk of Injury or Damage

“Qualified Technician Only” sections are marked accordingly.

- Set-up and Assembly instructions **MUST** be performed by qualified technicians only.

1. Count cartons before signing shipping papers.
2. Designate someone at the facility to receive and inspect all merchandise. Use the master order acknowledgment to check off items as they are received.
3. Compare the number of cartons shipped with the number of cartons actually received and note such on the consignee copy of the freight bill. Make sure to have the truck driver sign the copy acknowledging the count.
4. If shortage occurs, **IMMEDIATELY** contact Invacare Customer Service department at 1–800–668–2337.

4.2 Unpacking



DANGER!

Risk of Injury or Damage

Continued use of the product with damaged parts could lead to the bed malfunctioning, causing injury to the user and/or caregiver.

- Check ALL product components and carton for damage, and test components before use. In case of damage or if the product is not working properly, contact a qualified technician or Invacare for repair.



WARNING!

Risk of Injury or Damage

To avoid damage or personal injury:

- DO NOT plug the power cord into a power source until assembly is complete.
- DO NOT attempt to operate product controls prior to completion of assembly.



CAUTION!

Risk of Damage

To avoid product damage from misuse:

- DO NOT cut any trimmed plastic wire ties.
- Cut only the untrimmed plastic ties around the wood spacer. All other plastic ties are used to secure the electric cables in place and should not be cut.

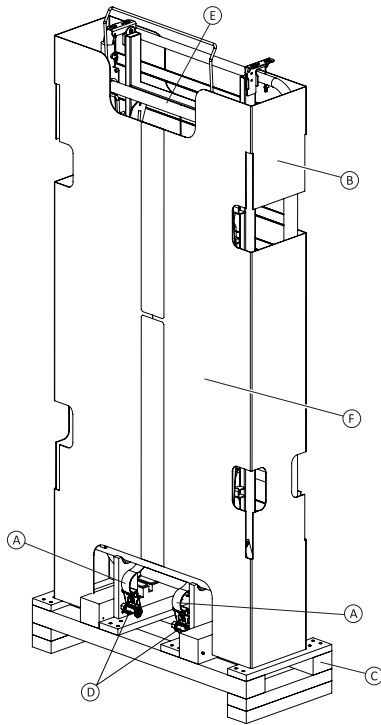



Fig. 4-1

1. Release/cut the straps (A) that secure the packaged bed (B) to the shipping pallet (C).
2. Remove the straps from the assembly.
 -  The bed is packaged so that the wheels (not shown) of the bed are always located on the same side as the latch mechanisms (D).
 -  Lowering the bed toward the side where the latch mechanisms were located will ensure that the wheels will be facing the ground when the bed is unpackaged.
The use of two people is preferred when lowering the bed to the floor.
3. Grab cross bar here (E) and slowly lower the bed toward the floor on the side where the straps were released/cut and removed.
4. Remove the corrugated wrap (F).

**WARNING!****Risk of Injury or Damage**

Bed damage or personal injury may occur if bed is dropped. To avoid:

- Slowly lower the bed to the floor.
- Use additional people if necessary.

5. Cut the untrimmed or green tie holding the head deck to the frame.

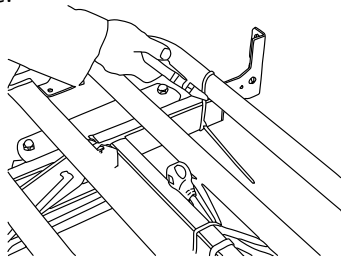

Fig. 4-2

6. Cut the untrimmed plastic tie holding the knee-foot panel to the frame.

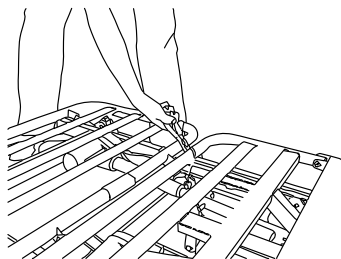

Fig. 4-3

7. Cut the untrimmed or green tie holding the mattress keepers on either side of the bed.

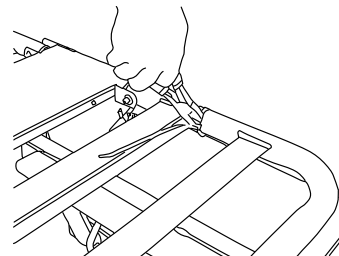

Fig. 4-4

8. Cut the untrimmed or green ties holding the mattress keepers at the end of the bed.

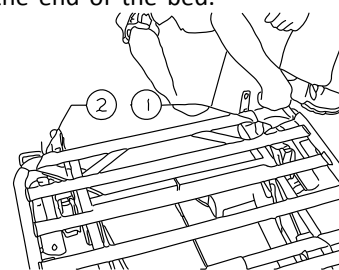

Fig. 4-5

9. Carefully cut the untrimmed or green tie holding the pendant bundle.

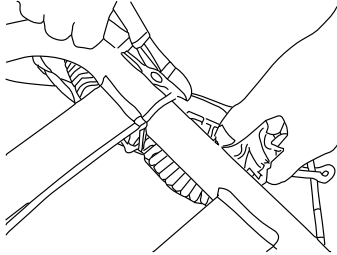

Fig. 4-6

10. Carefully cut the untrimmed or green tie holding the mains cable bundle.

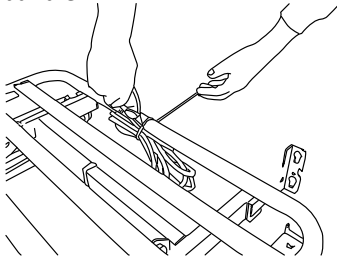

Fig. 4-7

11. Plug power cord into a properly grounded outlet.

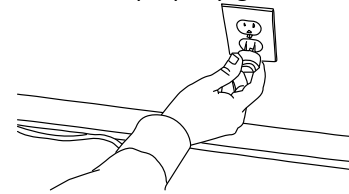

Fig. 4-8

12. Cut the untrimmed or green tie while holding the wall bumper.



Fig. 4-9

4.3 Inspecting



DANGER!

Risk Of Injury Or Damage

To avoid injury or damage, inspect the following and contact a qualified technician or Invacare if any of the following issues are present:

- Pendant covering is cracked or damaged.
- Power cord or plug have cuts or damage.
- Motor cables have cuts or damage.
- Junction box or connectors are damaged.



DANGER!

Risk Of Injury Or Damage

To avoid injury or damage:

- Ensure that the connectors are plugged into the junction box and fit properly.

4.4 Installing the Mattress Keeper Rod



WARNING!

Risk of Injury or Damage

To avoid a risk of entrapment due to gaps between the bed ends or rails and the mattress:

- Install the mattress keeper rods correctly and test to make sure they are securely in place before use.



The mattress keeper rods hold the mattress in place. Install them in the head and foot decks.

1. With the mattress keeper upright, insert the rod ends into the appropriate deck holes.
2. There are two choices for mattress keeper rod insertion. The 76 inch bed option should use the insertion holes closer to the inside of the bed, while the 80 inch bed option should use the holes closer to the outside of the bed.

76 inch Bed Option for All Models Except CS9FX600

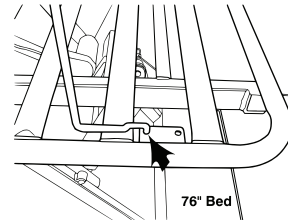

Fig. 4-10

80 inch Bed Option for All Models Except CS9FX600

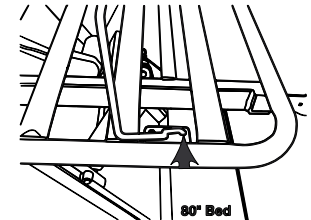

Fig. 4-11

76 inch Bed Option for Model CS9FX600

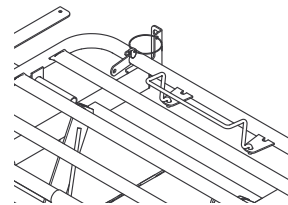

Fig. 4-12

80 inch Bed Option for Model CS9FX600

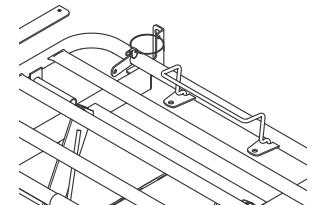

Fig. 4-13

3. Fold the mattress keeper around the bed in the rod. The mattress keepers should rest flat on the foot deck and the head deck.

All Models Except CS9FX600

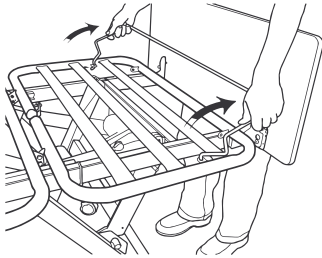

Fig. 4-14

Model CS9FX600

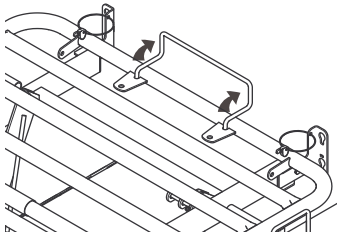

Fig. 4-15

4. 76 inch Bed Only - With a 7/16 inch socket wrench and 7/16 inch wrench loosen and remove the bed end bracket fasteners.

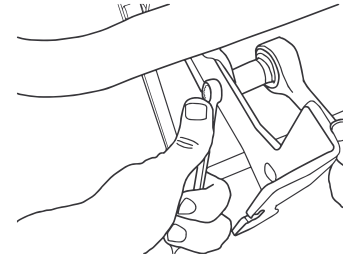

Fig. 4-16

5. 76 inch Bed Only - Remove the fasteners on the bed end bracket.

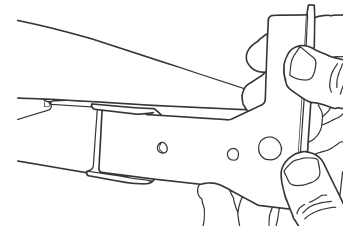

Fig. 4-17

6. 76 inch Bed Only - Slide the bed end bracket in the mounting channel. Align the hole in the bracket with the channel hole.

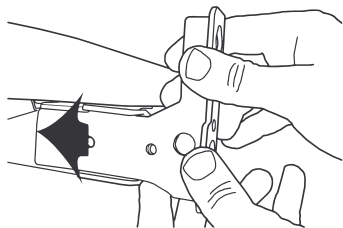

Fig. 4-18

7. 76 inch Bed Only - Reinsert the bed end bracket fasteners.

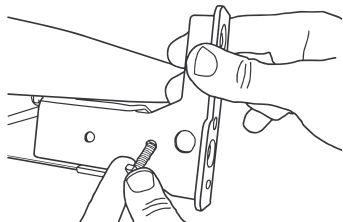
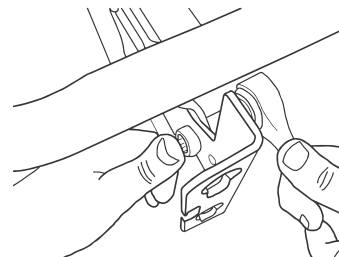

Fig. 4-19

8. 76 inch Bed Only - Tighten the fasteners with two 7/16 inch wrenches. Reposition the other three brackets and reapply the ends.



9. Position the mattress on the deck.

All Models Except CS9FX600

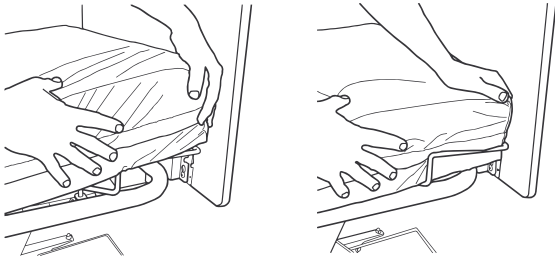

Model CS9FX600

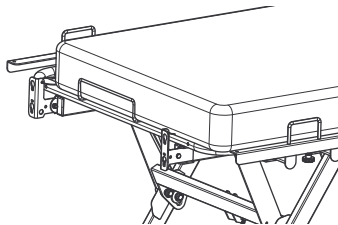

10. Press the mattress inside the mattress keeper. Ensure the mattress is engaged on all four corners.

4.5 Installing the Head and Foot Ends



Head and foot ends are normally packaged together either in a cardboard box or on a wooden skid separate from the bed.

Bed end model IHBEADJ must be used with bed model CS9FX600. Refer to *6.7 Adjustable Width Bed Model CS9FX600, page 50*.

1. Remove the key from the keyhole.

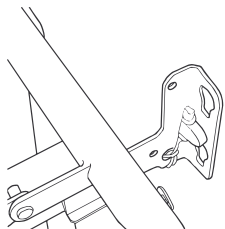

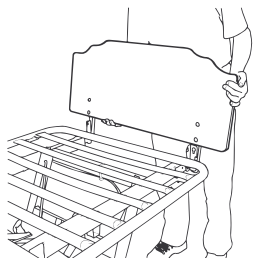

 Bed end not shown.

2. Position Head End next to the head board bracket. Hook the head post screws in the bracket slots.

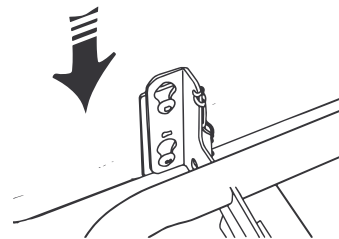

3. Slide the boards down while plate/post screws are in the bracket slots.



 Foot end shown.

4. Position Foot End next to the foot board brackets. Hook the board screws into the bracket slots.

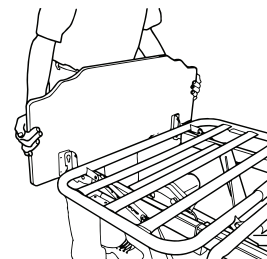

5. Guide the key through the small bracket hole. The key is attached to the bed bracket with a lanyard.

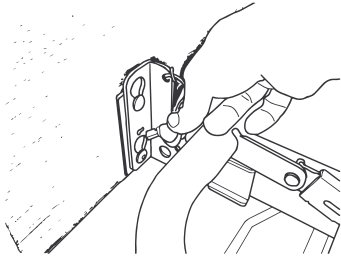

6. Turn and lock the key once it is fully inserted. Repeat on the other side, then the opposite bed end, securing both mounting points on each board.

 Some models only have one connection.

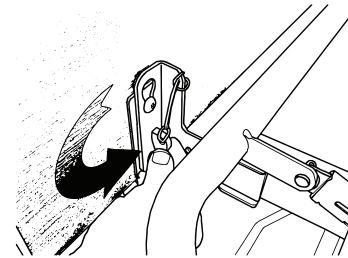

7. Attach the cables from the foot end board to the bed cables (ACP cable and pendant coupling). Tighten the nut*.

 *ACP bed only.

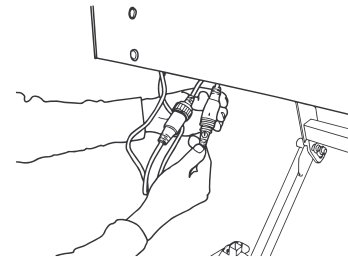

4.6 Storing the Bed



WARNING!

Risk of Injury or Damage

To avoid product damage and personal injury:
– DO NOT place other objects on top of the cartons.



WARNING!

Risk of Injury or Damage

To avoid product damage and personal injury:
– Disconnect pendant when not in use and store out of reach of children.

If bed is not being assembled immediately, retain the cartons and packaging for storage until ready for assembly.

Store the bed in a dry area.

5 Operation

5.1 Pendant Operation



WARNING!

Risk of Injury or Damage

To avoid electrical damage, product damage, shock and/or personal injury:

- DO NOT unplug power cord from junction box.
- When product is not to be used for an extended period, unplug product from the wall outlet.
- Keep all product components and accessories a minimum of 12 inches away from hot or heated surfaces.
- After the product has been assembled and before use, always test to make sure that all sections of the product are properly and securely in place. If any problems arise during the test, recheck all electrical connections and mechanical hook ups and then retest. If the product is not working properly, contact a qualified technician or Invacare for repair.



WARNING!

Risk of Injury or Damage

To avoid unintentionally pressing the pendant buttons and causing injury or damage.

- DO NOT place pendant under or between objects.



WARNING!

Risk of Injury or Damage

A safety feature of this product includes protection against overheating caused by excessive or extended periods of operation. Depending on the duration, this includes multiple or repeated adjustments or the use of multiple functions at one time.

- To ensure trouble free operation, ALWAYS allow a slight pause between multiple adjustments and avoid pressing more than one function button at a time. If thermal protection activation should occur, the product will not respond to pendant commands. Given this situation, release the pendant button and allow the product to sit for several minutes. This will allow the protection function time to reset and restore product function. Depending on severity of the initial overheating, this could take up to 30 minutes.
- After the thermal protection activation period is complete, the bed may be prone to sudden movement. Use caution when using the product after the protection function time has reset and the pendant function has been restored.



DANGER!

Risk of Death, Injury or Damage

Pendant malfunction may cause injury or damage.
 – Unplug bed from electrical outlet and contact qualified technician or Invacare for repair if any malfunction is detected.

Raising and Lowering

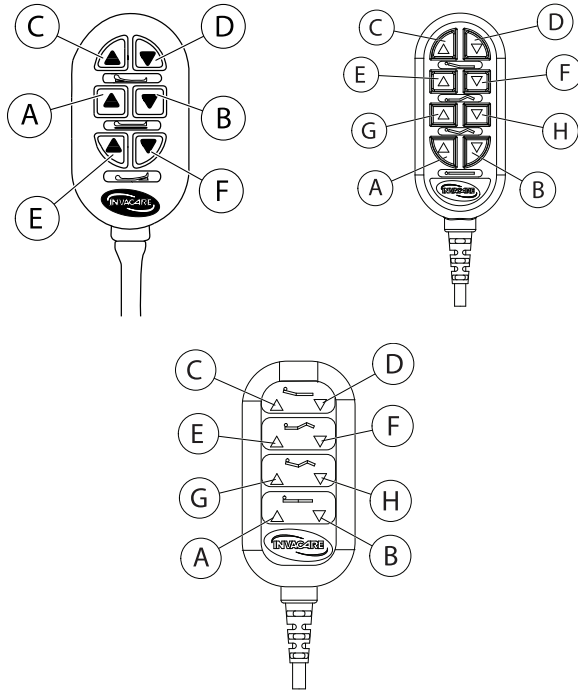

Entire Bed

1. To raise the entire bed, press the Bed Up button (A).
2. To lower the entire bed, press the Bed Down button (B).

Head and Foot Sections

1. To raise the head section, press the Head Up button (C).
2. To lower the head section, press the Head Down button (D).
3. To raise the foot section, press the Foot Up button (E).
4. To lower the foot section, press the Foot Down button (F).
5. To raise the head and foot sections simultaneously, press the Head and Foot Up button (G).
6. To lower the head and foot sections simultaneously, press the Head and Foot Down button (H).

5.2 Pendant Storage and Location



Before working on any electrical part, such as the 9-pin pendant coupling, ensure the main power to the bed is disconnected.

After disconnecting the power, sequentially depress the 'Up' and 'Down' buttons on the hand pendant at least 20 times to dispel any remaining charge. Ensure the hand pendant is not locked-out when performing this function.

1. Place the pendant holster between the top rail bars.

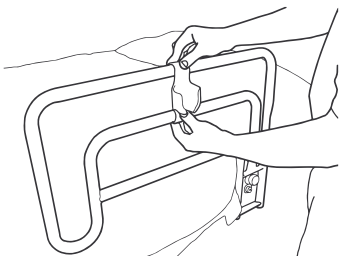

2. Slide the pendant into the holster.

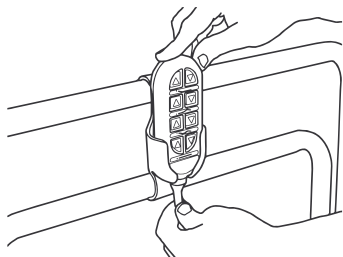

3. Alternatively, use the pendant clip to secure the pendant to bed linen.

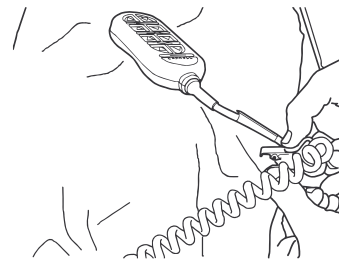

4. The pendant can also be attached to the back of either side of the Head end.

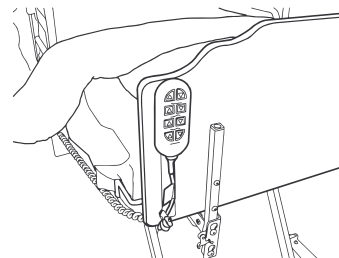

5. To move the pendant to the other side of the bed, disconnect the main power then unscrew the coupling cap on the pendant cable.

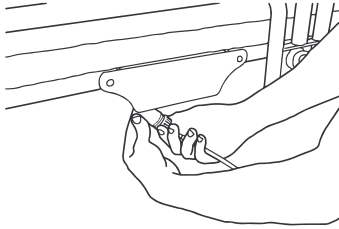

6. Remove the cable end from the Y cable housing.

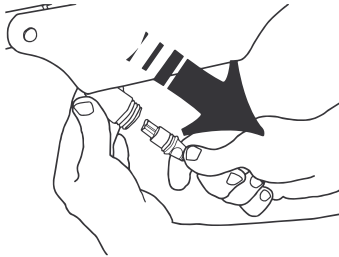

7. On the other side of the bed, remove the cap from the Y cable housing. Replace the cap on the other side of the bed.

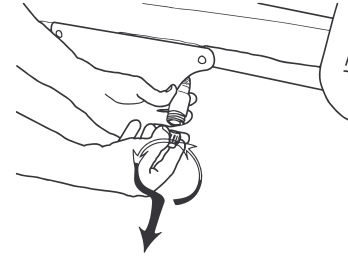

- Align arrows then insert the pendant cable end into the Y cable housing.

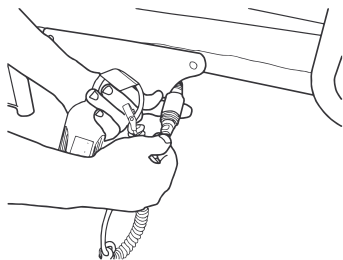

- Screw the coupling cap to the threaded Y cable housing end.

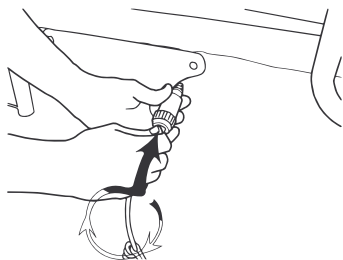

5.3 Power Cord Storage



Disconnect the main power cable from the wall outlet and store the power cord when the bed is not in use.

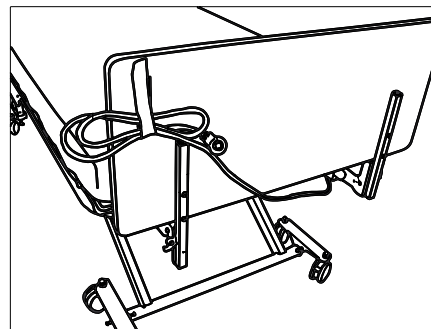

- Secure the power cord to the back of the head end with the hook and loop strap when moving the bed.
- Excess power cord can be secured to the back of head end with the hook and loop strap.

5.4 Raise and Lower the Heel Lift Ratchet

1. With knee-foot platform adjusted to the highest position, lift the foot panel.

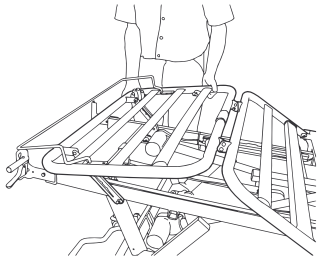

2. The foot section can rest at any of the six pre-set stops.

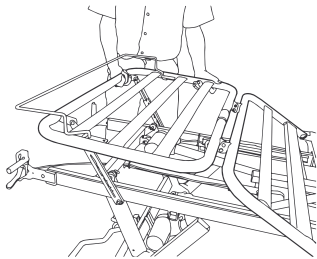

3. Slowly lower the platform to engage the nearest stop.

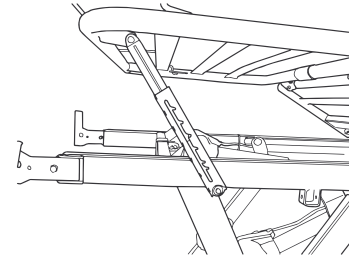

4. The platform cannot lower past the nearest stop while being adjusted.

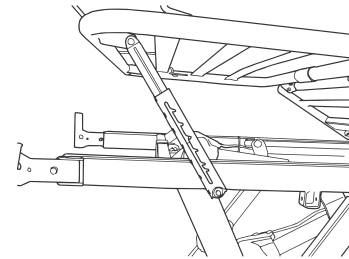

5. To reset the ratchet mechanism, raise the platform to the highest level then lower the platform in one motion.

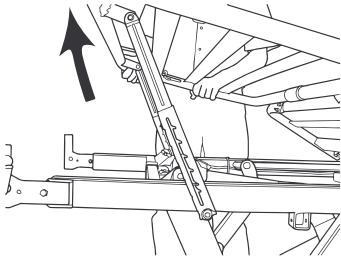

6. At the lowest position the deck can once again be raised to the desired stop.

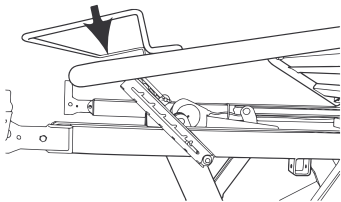

5.5 Foot Pad Lock Mechanism

For CS3 Model Only



CAUTION!

Risk of Damage

Moving the bed while the floor lock, caster lock or foot pad is engaged may damage the bed. To avoid:

- DO NOT move the bed unless the floor lock, caster lock or foot pad is disengaged (unlocked).

Mobility

Bed at the Lowest Position

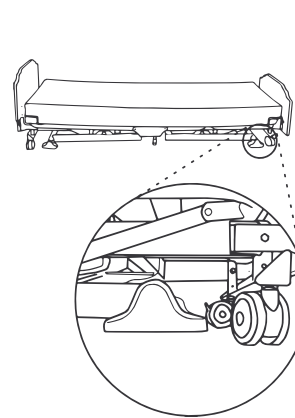

Stability Range

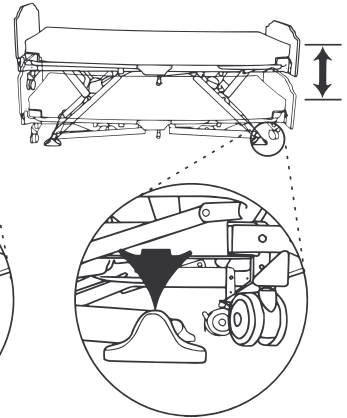

5.6 Bed Steer Mechanism

1. The steering mechanism is on either side of the head end of the bed.

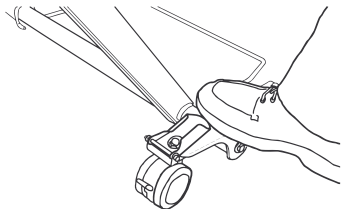

2. With the locking wheel tab facing outward, flip the steer mechanism.

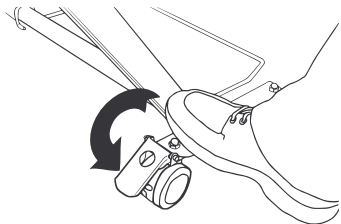

3. When engaged the bed will steer easily.

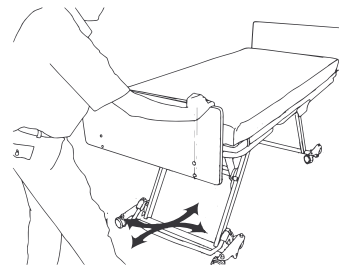

6 Optional Accessories

6.1 Bed Rails and Positioning Devices



DANGER!

Risk Of Death, Injury, Or Damage

Patient entrapment from the use of bed side rails may cause injury or death. To avoid patient entrapment:

- The Invacare mattress **MUST** fit firmly against the bed frame AND bed side rails to prevent patient entrapment. Follow the manufacturer’s instructions. Monitor patient frequently. Read and understand the User Manual prior to using the Invacare bed and bed rails. User manuals are available at www.invacare.com or your dealer.
- After any adjustments, repair or service and before use, make sure all attaching hardware is tightened securely.



DANGER!

Risk Of Death, Injury, Or Damage

To avoid entrapment, product damage, and/or personal injury:

- Invacare recommends that the mattress be centered on the bed frame. Otherwise, individuals may become trapped between the bed rail and the bed frame.
- **ALWAYS** test to make sure that the side rails are properly and securely in place before using. Otherwise, injury or damage may occur.



DANGER!

Risk Of Death or Injury

An increased risk of patient entrapment may occur over time due to mattress compression.

- Periodically monitor gaps between the bed, mattress, and/or bed rail. Where gaps occur, patient entrapment is possible and the mattress should be replaced.



DANGER!

Risk of Death, Injury or Damage

Proper patient assessment and monitoring, and proper maintenance and use of equipment is required to reduce the risk of entrapment.

Variations in bed rail dimensions, and mattress thickness, size or density could increase the risk of entrapment.

- Visit the FDA website at <http://www.fda.gov> to learn about the risks of entrapment. Review “A Guide to Bed Safety”, published by the Hospital Bed Safety Workgroup. Use the link located under each bed rail product entry to access this bed’s safety guide.



DANGER!

Risk Of Death, Injury, Or Damage

Conditions such as restlessness, mental deterioration and dementia or seizure disorders (uncontrolled body movement), sleeping problems, and incontinence can significantly impact a patient's risk of entrapment. Pediatric patients or patients with small body size may also have an increased risk of entrapment.

- Monitor patients with these conditions frequently.



WARNING!

Risk of Injury or Damage

To avoid injury or damage from instability, entanglement, or misuse:

- Evaluate residents prior to allowing them to use a trapeze.
- Only use the Invacare Heavy Duty Trapeze (1153386) with the CS Bed.
- Never allow children to use, play, or swing on the trapeze.
- The Heavy Duty Trapeze is NOT designed to support the total body weight of an individual. Use it for assistance ONLY.
- When in use, always rotate the trapeze until the handle is located over the center of the bed and ensure that it drops down into the anti-rotation position.



Safe Working Load of Heavy Duty Trapeze is 168 lb (72 kg). DO NOT exceed 168 lb (72 kg).



WARNING!

Risk of Injury or Damage

Contact between the floor and the assist rail may cause the bed to become unstable. An unstable bed may tilt from horizontal and/or drop suddenly causing property damage or personal injury. To avoid injury or damage from instability:

- Before lowering the bed, ensure the assist rail is not in the transfer position. Injury from patient falls may occur even when operating the side rails as instructed. Place the bed in the lowest position to minimize the risk from falls. For the CS3 bed only: Place the bed in the lowest position possible without disengaging the foot pad lock mechanism.
- Invacare recommends removing the trapeze when using the Trendelenburg function.
- DO NOT install an 84 Inch CS Bed kit on a bed that is equipped with the Trendelenburg and Reverse Trendelenburg feature.

**WARNING!****Risk of Injury or Damage**

Risk of FALL when Assist Bar is UNLATCHED. Assist Bar may rotate quickly and drop to the next locked position causing the patient to lose their balance and fall.

- Ensure the Assist Bar is fully latched in down position after each use.
- Check that the Assist Bar is locked before leaving a patient unattended.
- Never use the Assist Bar as a Rail.



If necessary, the head and foot end board position can be adjusted in order to meet FDA guidelines. Refer to *4.4 Installing the Mattress Keeper Rod, page 30* for detailed instructions on adjusting the end board bracket location.

The listed bed rails and positioning devices are available:

Model	Description
IHCSRLAS	CS Assist Rails - Set
IHCSRLAS-NG	CS No Guard Assist Rail - Set
IHCSBAAS	CS Assist Bar - Set
IHCSTSPD	ThinkSoft® Positioning Device TSPD
IHCSRLPA	68 Inch Rail
IHCSRLAS - 39NG	CS No Guard assist rail for 39 inch wide deck - set
IHCSRLAS - 42NG	CS No Guard assist rail for 42 inch wide deck - set
IHCSBAAS-39	CS assist bar for 39 inch wide deck - set
IHCSBAAS-42	CS assist bar for 42 inch wide deck - set

6.2 Other Accessories

The listed items are available as optional accessories:

Model	Description
IHCSBEK	84 Inch Extension Kit
IHCSTRPHD	Heavy Duty Trapeze and Mounting Bracket
BSTRANSPORTCS	Bed Transporter
IHCSBATPU-CB	Portable Battery Unit

6.3 Optional Touch-up Paint

Sherwin-Williams®

5A-58147 00(A)

CODE 82X

WHITE BIRCH

2nd Dimension 5.0 Acrylic Enamel

This product can be purchased at Sherwin Williams Automotive paint branches only.

6.4 Optional Attendant Control Panel Operation

The ACP panel is designed to be used alongside the pendant to adjust the height and position of the bed sections. It is also equipped with a lockout feature to temporarily disable pendant function for specific articulations of the bed.

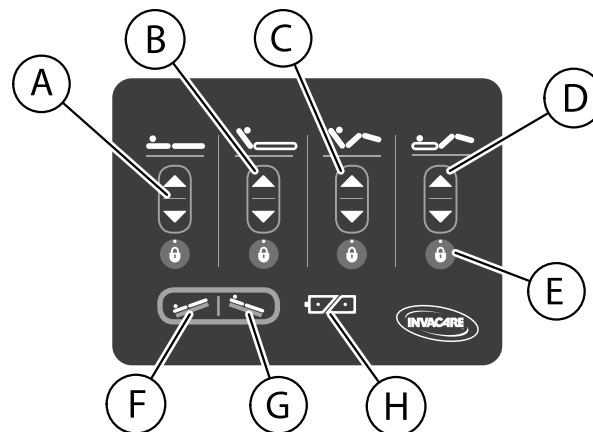

Adjusting the Bed

1. To raise and lower the entire bed, press the corresponding arrows (A).
2. To raise and lower the head section of the bed, press the corresponding arrows (B).

- To raise and lower the head and foot sections of the bed simultaneously, press the corresponding arrows ㉟.



This function is optional depending on whether the pendant also has this function.

- To raise and lower the foot section of the bed, press the corresponding arrows ㉞.

Lockout Feature

- To lock a specific pendant function, press the lock button ㉟ corresponding to the articulation that is being prevented.

Optional Trendelenburg and Reverse Trendelenburg Feature



CAUTION!

Risk of Damage

Use of Trendelenburg or Reverse Trendelenburg feature may not be appropriate for certain patients.

- Trendelenburg and Reverse Trendelenburg should only be used on the advice of a medical practitioner.
- Do not install a CS Bed Extender on a bed that is equipped with the Trendelenburg and Reverse Trendelenburg feature.

- To move the bed in a trendelenburg position, press the trendelenburg button ㉟.
- To move the bed in a reverse trendelenburg position, press the reverse trendelenburg button ㊸.

Optional Battery Indicator Light

For beds equipped with an optional battery, the ACP may be equipped with an indicator light ㉟ to show battery charge levels.

- A Yellow light indicates that the battery is charging.
- A Green light indicates that the battery is fully charged.

6.5 Optional Pendant HI/LO Lock Out



When in the “OFF” position, the HI/LO function on the pendant will NOT operate. When in the “ON” position, all pendant functions will operate normally. The head function and knee-foot function on the pendant remains operational whether the lock out is activated or deactivated.

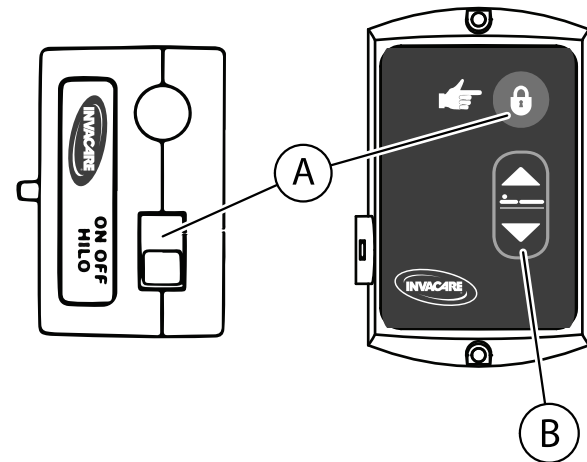

1. To operate the lockout function, either move the HI/LO switch Ⓐ to OFF or press the lock button Ⓐ.
2. When the lockout function is not activated, the arrow buttons Ⓑ can be used to raise and lower the bed.

6.6 Optional 39 Inch and 42 Inch Wide Decks

-  The following bed options are not compatible with the 39 inch or 42 inch wide bed deck: 68 inch rail.

The CS bed is available with wider decks for resident comfort. Both 39 inch wide deck and 42 inch wide decks are factory installed options.

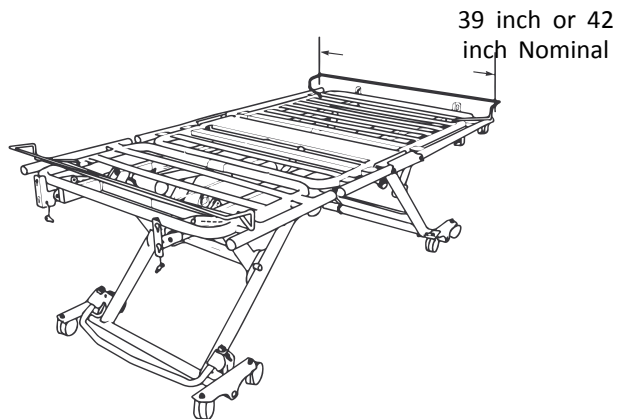

6.7 Adjustable Width Bed Model CS9FX600

-  The following bed options are not compatible with the CS9FX600: 68 inch rail.

6.7.1 Adjusting the CS9FX600 Bed Width

-  All eight adjustable deck wings must be adjusted to the same width. Ensure the appropriate bed and head board settings are used as described in this procedure.

The CS9FX600 has eight adjustable deck wings which can be adjusted to 36 in, 39 in or 42 in. The locations of the wings and adjustment knobs are shown in the figure below.

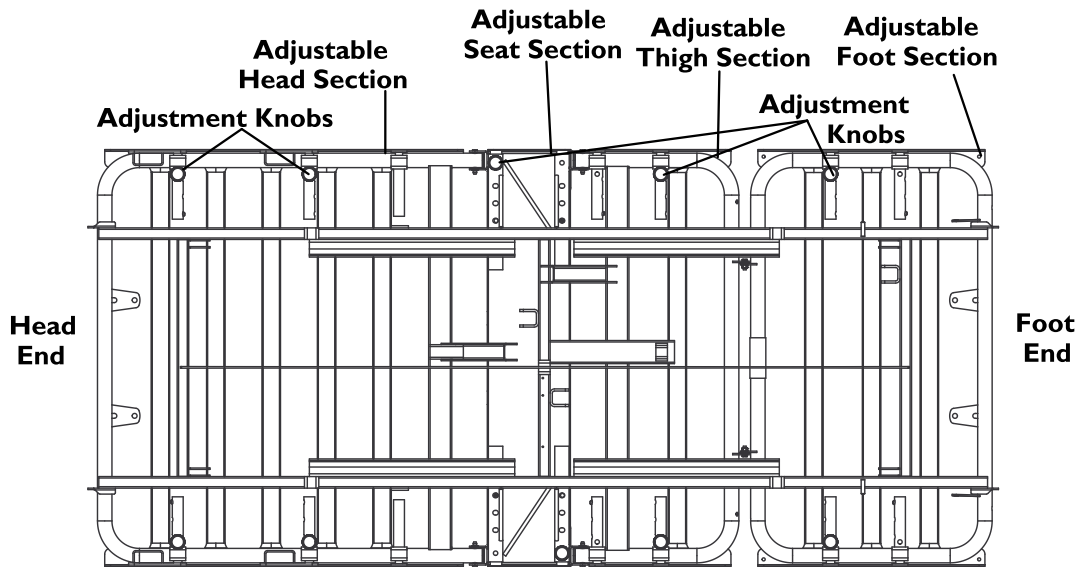

i Opposite side is the same as labeled side.

**36 inch Width
Side View**

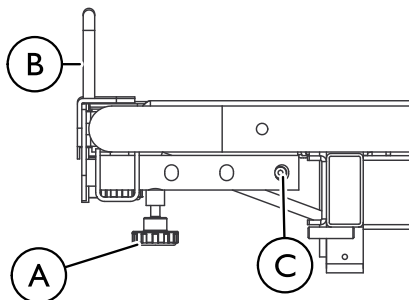

Top Bed Deck View

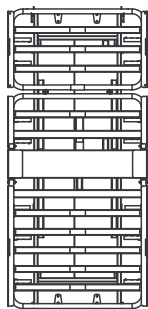

**39 inch Width
Side View**

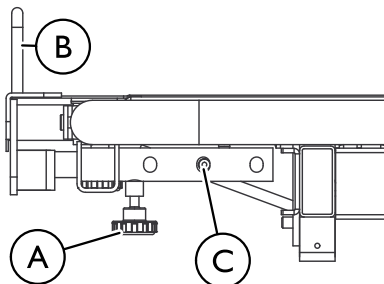

Top Bed Deck View

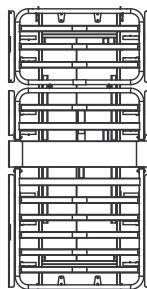

**42 inch Width
Side View**

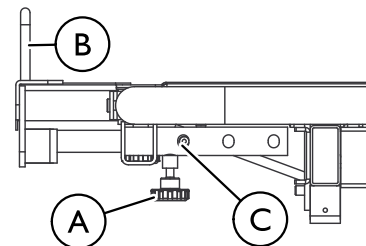

Top Bed Deck View

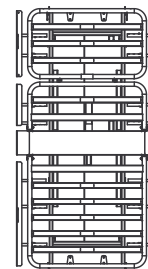

1. Loosen the knob **A** securing the adjustable deck wing **B**.
2. Depress the snap button **C**.

3. Slide the adjustable deck wing in or out to the desired position.
4. Ensure the snap button snaps into the appropriate adjustment hole.

5. Tighten the knob to secure the adjustable deck wing.
6. Adjust the head board width. Refer to *6.7.2 Adjusting the Head Board Width for CS9FX600*, page 53.
7. Repeat steps 1 to 6 for each section until they are all adjusted to the same width.

6.7.2 Adjusting the Head Board Width for CS9FX600

Bed end model IHBEADJ is intended for use on bed model CS9FX600. The head board is adjustable and ships in the position for a 36 in wide bed.

1. Firmly grasp one of the board wings (A).
2. While holding that wings, remove the knobs (B) securing that wings to the center section (C).
3. Move the board wing until the mounting holes line up with the desired adjustment holes in the center section.
4. Install the knobs to secure the board wing in the desired position. Tighten securely
5. Repeat steps 1-4 for the remaining board wing.

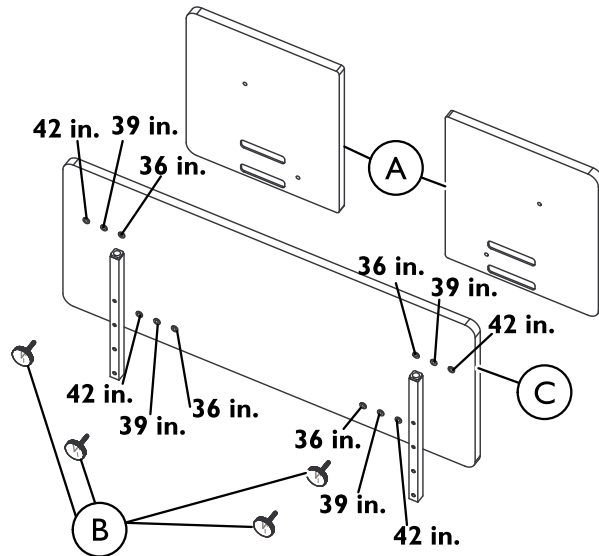

7 Maintenance

7.1 Cleaning



WARNING!

Risk of Injury or Damage

To avoid injury or damage from misuse:

- Read all guidelines, warnings and cautions before performing any repair/maintenance on the bed.
- All repair and maintenance on the bed should be performed by a qualified technician.



DANGER!

Risk of Death, Injury or Damage

To avoid damage to electric controls:

- If a liquid is spilled in or around the electric bed, unplug the electric bed before cleaning.
- Clean up the spill and allow the electric bed or the area around the electric bed to dry thoroughly before using the electric controls again.



WARNING!

Risk of Injury or Damage

Grease may leak from the gearbox and cause injury or damage from falling or fire.

- Follow the maintenance instructions in this manual.
- Routinely inspect the gearbox for grease leakage.

If the gearbox is leaking grease:

- Stop use immediately.
- Keep the product away from sparks, flame and open heat sources.
- Contact your dealer or Invacare for repair.



WARNING!

Risk of Injury or Damage

The electric motors, control box and pendant are NOT protected against the entrance of dust and liquids.

- DO NOT spray liquids into any electrical components.
- DO NOT wash head or foot section.
- DO NOT allow electrical components to get wet.





WARNING!

Risk of Injury or Damage

To avoid product damage or injury from malfunction:

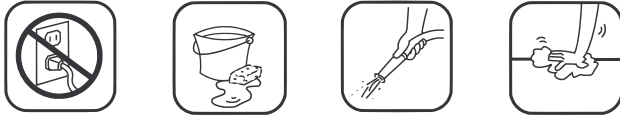
- Clean the product according to the instructions.
- The product may be damaged from multiple or excessive cleaning.



1. Unplug product before washing.
2. Make sure all electrical parts (motors, control box and pendant) are not damaged and that all connection ports are plugged. DO NOT allow liquids to enter electrical components.
3. Disinfect and wash all components. DO NOT submerge the bed frame or electrical parts.
4. DO NOT power wash or steam-clean. Use household water pressure only.
5. Rinse thoroughly with water (maximum temperature 110°F or 43°C).
 -  DO NOT use solvents, bleach, alcohol, petroleum products, caustic agents, or highly alkaline or acidic agents to clean the bed.
6. Retract each actuator to the minimum stroke length before washing to avoid degreasing the piston rod.
7. Dry all components before storing.

7.2 Annual Maintenance Check

- Inspect the covering of the bed's control panel and the patient control panel to assure that the covering is not cracked or damaged.
- Inspect for damaged or loose wiring. Have a qualified technician replace any frayed or damaged cords.
- Inspect for secure grounding.
- Inspect rail latches. Ensure that all rails engage and lock as specified.
- Inspect rails for wear and damage and replace as required.
- Lubricate rail pivot points as needed with white lithium grease.
- Inspect bed, rails, Assist Rails or Assist Bars for the presence of tubing end caps and replace as required.
- Tighten, adjust or replace any parts or bolts etc. that are loose or show signs of wear.
- Lubricate all mechanical hinge points, bushings, and surface contact points with white lithium grease.
- Inspect for wear on clevis pins and hitch pins and replace if worn or missing.
- Inspect the rails for noticeable scratches and chips. Use a matching enamel touch up paint to retouch if necessary. (Refer to Options for paint specification).

7.3 Quarterly Maintenance Check

- Unplug bed from wall outlet and verify battery function, if equipped. Battery may be built-in or portable.

8 Troubleshooting

8.1 Troubleshooting

Effect	Possible cause	Verification	Corrective action
Bed does not stay in place	Floor lock not engaged.	Green plunger on floor lock post is visible.	Activate floor lock - green plunger should NOT be visible.
	Insufficient static friction between floor lock foot bumper and floor.	Floor surface is slippery and/or foreign membrane between bumper and floor.	Clean the surrounding floor and remove loose material under the bed.
	Floor lock not functioning.	Floor lock is stuck in one position.	Contact Invacare Continuing Care Service Department 1-800-668-2337.
Bed is not level	Hi/Lo actuators are unevenly extended	Bed deck is not parallel with floor	Raise bed to highest position or Lower bed to lowest position
Actuator not working.	System Fault Needs Reset	Flashing LEDs on ACP, Bed function will not operate. The control box may beep when pendant function is pressed.	To Reset - hold the pendant bed up and bed down buttons for 5+ seconds. The bed will beep and stop beeping when reset is complete. Then press the bed up button. If the bed beeps, the actuators are out of sync. Continue rising to the highest position to synchronize the actuators.

Effect	Possible cause	Verification	Corrective action
<p>Actuator not working.</p>	<p>HI/LO lock-out is on.</p>	<p>For non-openbus (CS3, CS5) - A Lockout box (a square black box) with a toggle switch. When the switch is towards "ON" side, the HILO on the hand pendant will not function. There is no LED light.</p> <p>For openbus beds (CS7, CS9, CS9FX600) - The lockout box (a flatter rectangular white box) with a toggle dome button and LED light. When the light is on, the HILO on the hand pendant will not function.</p>	<p>Rotate the lockout dial to the "unlocked" position (horizontal), or flip switch to OFF.</p>
		<p>Lockout LED on the Attendant Control Pad (ACP) is ON.</p>	<p>Toggle-off the individual function lockout (LED should be OFF)</p>
	<p>Loose wire connections.</p>	<p>Check cable connections visually.</p>	<p>Connect any loose cable couplings and/or power supplies.</p>

Effect	Possible cause	Verification	Corrective action
Actuator not working.	Faulty actuator.	Disconnect power supply, swap cable from unresponsive actuator with a functional actuator. Reconnect power and test functions. Faulty actuator will not work regardless of the connection port.	Contact Invacare Continuing Care Service Department 1-800-668-2337.
Actuator not working.	Faulty hand control pendant.	Pendant cable is connected, power is on, lock-out is off and hand control pendant does not function. Disconnect power supply then replace hand pendant with functioning unit (from another bed, if available). Reconnect power and test.	Contact Invacare Continuing Care Service Department 1-800-668-2337.
Bed ends to not fit properly.	Bent brackets.	Visually ensure the brackets are parallel to the frame.	Carefully straighten minor deformations. Call Service Department to replace significantly bent brackets, 1-800-668-2337.

9 Warranty

9.1 Limited Warranty



PLEASE NOTE: THE WARRANTY BELOW HAS BEEN DRAFTED TO COMPLY WITH FEDERAL LAW APPLICABLE TO PRODUCTS MANUFACTURED AFTER JULY 4, 1975.

This warranty is extended only to the original purchaser who purchases this product when new and unused from Invacare Continuing Care, Inc (ICCI) or a dealer. This warranty is not extended to any other person or entity and is not transferable or assignable to any subsequent purchaser or owner. Coverage under this warranty will end upon any such subsequent sale or other transfer of title to any other person.

This warranty gives you specific legal rights and you may also have other legal rights which vary from state to state.

ICCI warrants the frame and welds on this product when purchased new and unused will be free from structural defects on the frame for a period of ten (10) years, electrical for a period of three (3) years, and mechanical for a period of five (5) years from date of purchase from ICCI or a dealer, with a copy of the seller's invoice required for coverage under this warranty. ICCI warrants the frame of this product when purchased new and unused to be free from defects in materials and workmanship for a period of ten (10) years from date of purchase from ICCI or a dealer, with a copy of the seller's invoice required for coverage under this warranty. For all other components of this product when purchased new and unused, ICCI warrants that they will be free from defects in material and workmanship for a period of one (1) year from date of purchase from ICCI or a dealer, with a copy of the seller's invoice required for coverage under this warranty. Upholstery (vinyls, fabrics and/or laminates) are not covered under this warranty. If within such warranty periods any such product shall be proven to be defective, such product shall be repaired or replaced, at ICCI's option. This warranty does not include any labor or shipping charges incurred in replacement part installation or repair of any such product. ICCI's sole obligation and your exclusive remedy under this warranty shall be limited to such repair and/or replacement.

For warranty service, please contact the dealer from whom you purchased your ICCI product. In the event you do not receive satisfactory warranty service, please write directly to ICCI at the address on the back cover, provide dealer's name, address, and the date of purchase, indicate nature of the defect and, if the product is serialized, indicate the serial number. Do not return products to our factory without our prior consent.

LIMITATIONS AND EXCLUSIONS: THE FOREGOING WARRANTY SHALL NOT APPLY TO SERIAL NUMBERED PRODUCTS IF THE SERIAL NUMBER HAS BEEN REMOVED OR DEFACED, PRODUCTS SUBJECT TO NEGLIGENCE, ACCIDENT, IMPROPER OPERATION, MAINTENANCE OR STORAGE, PRODUCTS MODIFIED WITHOUT ICCI'S EXPRESS WRITTEN CONSENT (INCLUDING, BUT NOT LIMITED TO, MODIFICATION THROUGH THE USE OF UNAUTHORIZED PARTS OR ATTACHMENTS; PRODUCTS DAMAGED BY REASON OF REPAIRS MADE TO ANY COMPONENT WITHOUT THE SPECIFIC CONSENT OF ICCI, OR TO A PRODUCT DAMAGED BY CIRCUMSTANCES BEYOND ICCI'S CONTROL, AND SUCH EVALUATION WILL BE SOLELY DETERMINED BY ICCI. THE WARRANTY SHALL NOT APPLY TO NORMAL WEAR AND TEAR OR FAILURE TO ADHERE TO THE PRODUCT INSTRUCTIONS.

“THE FOREGOING EXPRESS WARRANTY IS EXCLUSIVE AND IN LIEU OF ANY OTHER WARRANTIES WHATSOEVER, WHETHER EXPRESS OR IMPLIED, INCLUDING THE IMPLIED WARRANTIES OF MERCHANTABILITY AND FITNESS FOR A PARTICULAR PURPOSE, AND THE SOLE REMEDY FOR VIOLATIONS OF ANY WARRANTY WHATSOEVER, SHALL BE LIMITED TO REPAIR OR REPLACEMENT OF THE DEFECTIVE PRODUCT PURSUANT TO THE TERMS CONTAINED HEREIN. THE APPLICATION OF ANY IMPLIED WARRANTY WHATSOEVER SHALL NOT EXTEND BEYOND THE DURATION OF THE EXPRESS WARRANTY PROVIDED HEREIN. ICCI SHALL NOT BE LIABLE FOR ANY CONSEQUENTIAL OR INCIDENTAL DAMAGES WHATSOEVER.”

Invacare Continuing Care, Inc. A subsidiary of Invacare Corporation.

Invacare Continuing Care, Inc.

www.invacare-cc.com

USA

One Invacare Way

Elyria, Ohio USA

44035

1-800-668-2337

Canada

570 Matheson Blvd E Unit 8

Mississauga Ontario

L4Z 4G4 Canada

800-668-5324

Designed by Invacare Corporation

Manufactured in Mexico for Invacare Corporation

Invacare Australia Pty. Ltd.

1 Lenton Place

North Rocks NSW 2151

Sydney, Australia

1800 460 460



1153410-Q 2018-08-08



Making Life's Experiences Possible®



Yes, you can.®