

Precision in Preparation, Injection and Application

With B. Braun single-use syringes
and needles





Precision in preparation, injection and application





For precise preparation, injection and application, B. Braun offers an extensive range of single-use syringes and needles.

The range of single-use syringes includes 2-piece and 3-piece syringes, fine dosage syringes including Low Dead Space versions and those for special indications like heparin and insulin with dedicated scalings. It furthermore includes Original Perfusor® Syringes, catheter tip syringes, oral syringes as well as syringes with ENFit® and NRFit® connectors.

The range of single-use needles includes needles for pen injection systems, conventional hypodermic needles, blunt needles as well as safety and drug admixture needles.

Table of Content



Syringes

	Overview	
	B. Braun Syringes	6
	B. Braun Needles	7
	Syringe Terminology	
	Components, Types and Connectors	8
	2-Piece Syringes	
	Injekt® Luer Solo	12
	Injekt® Luer Lock Solo	13
	Injekt® Luer Duo	14
	2-Piece Fine Dosage Syringes	
	Injekt®-H Luer Solo (Type LDS)	16
	Injekt®-F Luer Solo, Injekt®-F Luer Duo (Type LDS)	17
	3-Piece Syringes	
	Omnifix® Luer Solo	20
	Omnifix® Luer Lock Solo	21
	Omnifix® Luer Duo	22
	3-Piece Fine Dosage Syringes	
	Omnifix®-H Luer Solo	25
	Omnifix®-F Luer Solo, Omnifix®-F Luer Duo	26
	Low Dead Space Syringes	27
	Omnifix®-F Luer Lock Solo (Type LDS)	28
	Omnican® F (Type LDS)	29
	Precise Aspiration & Injection with B. Braun Syringes	30
	Irrigation Syringes	
	Omnifix® Irrigation Syringe	33
	SOL-M™ Catheter Tip Syringe without Needle	35
	3-Piece Syringes for Use with Perfusor® Syringe Pumps	
	Original Perfusor® Syringe	37
	3-Piece Syringes & Accessories for Neurexial and Regional Anesthesia	
	Omnifix® Slip (Type NRFit®), Omnifix®-F Slip (Type NRFit® and LDS)	40
	Omnifix® Lock (Type NRFit®)	41
	Original Perfusor® Syringe (Type NRFit®, Lock) and Closure Cap (Type NRFit®)	42
	3-Piece Syringes for the Loss of Resistance (LOR) Technique in Epidural Anesthesia	
	Perifix® LOR Syringe (Type NRFit®)	44
	Perifix® LOR Syringe	45
	Oral Syringes	
	2-Piece Syringes for Oral Applications	
	Exadoral®, Exadoral® (Type LDS)	47
	Exadoral® Straws and Bottle Adapter	48
	3-Piece Syringes and Devices with ENFit® Connector for Enteral Applications	
	Enteral Syringes (Type ENFit®)	52
	Enteral Straw and Syringe Cap (Type ENFit®)	53

Syringes

	Insulin Syringes	
	2-Piece Insulin Syringes	
	Injekt® 40 (Type LDS)	56
	3-Piece Insulin Syringes	
	Omnifix® 40, Omnifix® 100	57
	Omnican® 20/40, Omnican® 50/100 (Type LDS)	58

Needles

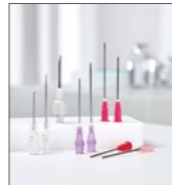
	Pen Needles	
	Omnican® fine	61
	Omnican® fine Comfort	63
	Needle Terminology	
	Components	64
	Injection Routes	
	Techniques and Application	65
	Hypodermic Standard, Blunt and Safety Needles	
	Sterican®	68
	Handling Instructions Sterican®	70
	Sterican® Blunt	71
	Sterican® Safety Needle	73
	Product Details Sterican® Safety Needle	74
	Handling Instructions Sterican® Safety Needle	76
	Admixture Needles	
	Types and Application Semi-Blunt and Blunt Needles	80
	Use of 2-Needle Technique Semi-Blunt and Blunt Needles	81
	Sterican® MIX Semi-Blunt Needle	82
	Sterican® MIX Blunt Needle	83
	Sterifix® Filter Needle	84
	Sterifix® Filter Needle NRFit®	85
	Aspiration needle	86

Sharps Disposal Container

	Medibox®	89
	Handling Instructions Medibox®	90

Overview B. Braun Syringes

Standard Syringes

Size	2-Piece Syringes			3-Piece Syringes		
	Luer		Luer Lock	Luer		Luer Lock
	Solo	Duo	Solo	Solo	Duo	Solo
2 ml	■	■	■	■	■	■
3 ml				■	■	■
5 ml	■	■	■	■	■	■
10 ml	■	■	■	■	■	■
20 ml	■	■	■	■	■	■
30 ml				■		■
50 ml				■		■

Special Syringes

Size	2-Piece Syringes	3-Piece Syringes						
	Oral Dispenser	Loss of Resistance Syringe		Original Perfusor® Syringe		Catheter Tip	NRFit®	ENFit®
		Luer & Luer Lock	NRFit® Slip & Lock	with & without aspiration needle	NRFit® Lock		Slip & Lock	
2 ml	■							■
3 ml							■	
5 ml	■						■	■
8 ml		■	■					
10 ml	■						■	■
20 ml	■			■			■	■
50 ml				■	■	■	■	
60 ml								■
100 ml						■		

Fine Dosage Syringes

Size	2-Piece Syringes		3-Piece Syringes						
	Luer		Oral Dispenser	Luer		Luer Lock	NRFit® Slip	ENFit®	with integrated needle
	Solo	Duo		Solo	Duo	Solo			30 G x 12 mm
1 ml non LDS				■	■	■	■		
1 ml LDS	■	■	■			■			■

Insulin Syringes

Graduation	Size	2-Piece Syringes		3-Piece Syringes		3-Piece Syringes	
		Luer		Luer		with integrated needle	
		Solo	Duo 26 G x 12 mm	Solo	Duo 26 G x 12 mm	30 G x 8 mm	30 G x 12 mm
U-40	0.5 ml					■	
	1 ml	■	■	■	■	■	■
U-100	0.5 ml					■	■
	1 ml			■	■	■	■

Overview B. Braun Needles

Hypodermic, Admixture & Pen Needles

Gauge	Length (inch)	Length	Hypodermic Needles			Admixture Needles			Pen Needles	
			Sterican®	Sterican® Safety Needle	Sterican® Blunt	Sterican® MIX	Sterifix® Filter Needle	Aspiration needle	Omnican® fine	Omnican® fine Comfort
32 G	3/16"	4 mm							■	
	1/4"	6 mm							■	
31 G	3/16"	4 mm							■	■
	1/4"	6 mm							■	■
	5/16"	8 mm							■	■
30 G	1/2"	12/13 mm	■	■						
29 G	1/2"	12 mm							■	■
	1/2"	12/13 mm	■	■						
27 G	3/4"	20 mm	■							
	1"	25 mm	■		■					
	1 1/2"	40 mm	■							
26 G	1/2"	12/13 mm	■	■						
	1"	25 mm	■							
25 G	5/8"	16 mm	■	■						
	1"	25 mm	■	■						
24 G	1 1/2"	40 mm	■	■						
	1"	25 mm	■	■						
23 G	1 1/4"	30 mm	■	■						
	1 1/2"	40 mm	■	■						
	2 3/8"	60 mm	■							
	3 1/8"	80 mm	■							
22 G	1"	25 mm		■						
	1 1/4"	30 mm	■	■						
	1 1/2"	40 mm	■	■						
	2"	50 mm	■							
	7/8"	22 mm			■					
21 G	1"	25 mm	■	■						
	1 1/4"	30 mm	■	■						
	1 1/2"	40 mm	■	■						
	2"	50 mm	■							
	3 1/8"	80 mm	■							
20 G	4 3/4"	120 mm	■							
	1"	25 mm	■	■						
	1 1/2"	40 mm	■	■						
19 G	2"	50 mm	■							
	1"	25 mm							■	
	1 1/4"	30 mm	■							
18 G	1 1/2"	40 mm	■	■				■		
	2"	50 mm	■					■		
14 G	1 1/10"	28 mm							■	
	1 1/4"	30 mm							■	

Syringe Terminology

Components

Zero Line
Fiducial line aligns with the zero line on the syringe barrel when the plunger is fully inserted.

Barrel
The barrel of the syringe contains the fluid for various applications. The barrel features a clear and transparent wall for easy identification of fluid level as well as air bubbles.

Lubricant
To allow smooth plunger movement, the syringe barrel material contains a lubricant (according to ISO 7886-1). 3-piece syringes additionally feature a siliconized inner barrel surface and a plunger stopper for slow aspiration and injection.

Barrel Stop Ring
The barrel has a stop ring inside to avoid unintentional plunger removal when aspirating fluid. A resistance can be felt before pulling out the plunger completely.

Push-Button
The push-button features ribs that help to prevent the user's thumb from slipping off when pushing the plunger during injection.

Fiducial Line
Leading edge on the plunger stopper. This line is the orientation for the user to identify the intended injection dose inside of the syringe.

Plunger stopper
The plunger stopper is connected to the end of the plunger.

Graduation Lines
Scale interval.

Nominal Capacity
Capacity of the syringe stated by the manufacturer.

Total Graduated Capacity
Maximum graduated capacity of the syringe.

Barrel Flanges
The barrel flanges provide a secure finger grip area to support aspiration and injection of fluid.

Plunger
Syringe component to aspirate and deliver the fluid.

Syringe Terminology

Types

2-Piece Syringe
The syringe comprises two components: barrel & plunger.

3-Piece Syringe
The syringe includes three components: barrel, plunger & plunger stopper.

3-Piece Syringe with Integrated Needle
The syringe comprises three components: barrel, plunger and plunger stopper. Additionally, they feature an integrated needle that is covered by a needle protection cap.

Low Dead Space Syringe
Syringes (Type LDS) ensure reduced residual volume due to e.g. displacement spike or integrated needle.

Solo Version
Primary packaging includes one syringe.

Duo Version
Primary packaging includes one syringe and one detached needle.

Syringe Terminology

Connectors

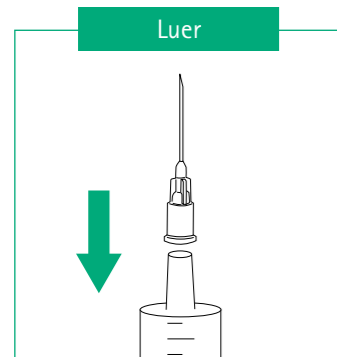

Luer

Connection by pushing the medical device on the Luer (male) connector (+ 1/4 turn clockwise). The connector is designed according to ISO 594/ISO 80369-7 and allows the syringe to be compatible with other medical devices that feature a Luer (female) or Luer Lock (female) connector.

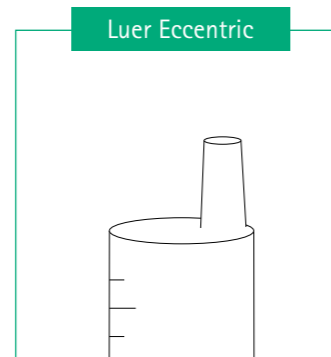

Luer Eccentric

The syringe with eccentric Luer (male) connector allows the user to aspirate and inject fluid closer to the patient's skin. It is generally used for e.g. IV applications or blood collection. The connector is designed according to ISO 594/ISO 80369-7 and allows the syringe to be compatible with other medical devices that feature a Luer (female) or Luer Lock (female) connector.

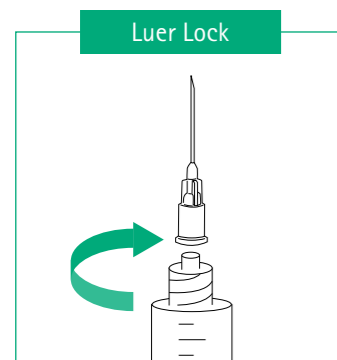

Luer Lock

The Luer Lock connector features a locking mechanism and is therefore the preferred choice for applications that require a secure connection. The device gets connected by twisting it onto the Luer Lock (male) connector of the syringe. The connector is designed according to ISO 594/ISO 80369-7 and allows the syringe to be compatible with other medical devices that feature a Luer (female) or Luer Lock (female) connector.

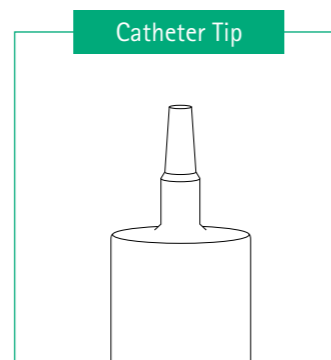

Catheter Tip

Catheter tip design used for irrigation or withdrawal of fluid from a body cavity or wound.

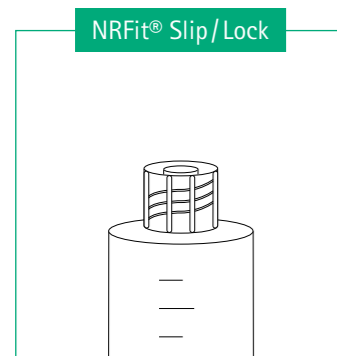

NRFit® Slip/Lock

The international standard design for neuraxial and regional anesthesia applications to reduce the risk of wrong route medication errors. The connector is designed according to ISO 80369-6 and allows the syringe to be compatible with other medical devices that feature a NRFit® Slip (female) or NRFit® Lock (female) connector.

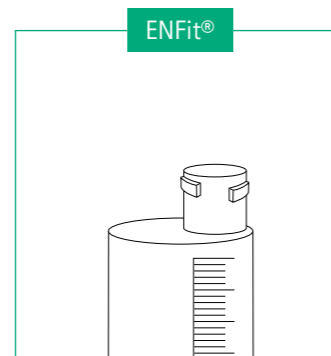

ENFit®

The international standard design for enteral application systems to prevent unintentional connections between enteral and intravenous systems. The connector is designed according to ISO 80369-3 and allows the syringe to be compatible with male ENFit® connectors.

2-Piece Syringes and 2-Piece Fine Dosage Syringes

Injekt®, Injekt®-F, Injekt®-H

With Injekt®, B. Braun offers a broad range of 2-piece single-use syringes with Luer and Luer Lock connectors in various sizes. In addition fine dosage syringes (Type LDS) with and without heparin graduation are included.



Injekt® Luer Solo

2-piece syringes with Luer connector



Product Features

- Green plunger
- Highly transparent barrel
- Black graduation
- Integrated plunger backstop (1)
- Graduation extended beyond nominal volume
- Luer connector
- Barrel made of polypropylene
- Plunger made of polyethylene
- Not manufactured with silicone oil, PVC, Latex, DEHP and BPA
- Sterile single packaging
- Box of 100 pcs.

User Benefits

- Green plunger for precise dosage
- Highly transparent barrel with black graduation for easy reading
- Safe plunger backstop helps to prevent unintentional plunger withdrawal and the loss of any liquids

Injekt® Luer Solo

2-piece syringes with Luer Lock connector



Product Features

- Green plunger
- Highly transparent barrel
- Black graduation
- Integrated plunger backstop (1)
- Graduation extended beyond nominal volume
- Luer Lock connector
- Barrel made of polypropylene
- Plunger made of polyethylene
- Not manufactured with silicone oil, PVC, Latex, DEHP and BPA
- Sterile single packaging
- Box of 100 pcs.

User Benefits

- Green plunger for precise dosage
- Highly transparent barrel with black graduation for easy reading
- Safe plunger backstop helps to prevent unintentional plunger withdrawal and the loss of any liquids



Injekt® Luer Solo, manufactured according to ISO 7886-1

Size	Cone	Graduation	Total Graduated Capacity	Units Per Box	Code No. (REF)
2 ml	Centric	0.1 ml	3.0 ml	100 pcs.	4606027V
5 ml	Eccentric	0.2 ml	6.0 ml		4606051V
10 ml	Eccentric	0.5 ml	12.0 ml		4606108V
20 ml	Eccentric	1.0 ml	24.0 ml		4606205V



Injekt® Luer Lock Solo, manufactured according to ISO 7886-1

Size	Cone	Graduation	Total Graduated Capacity	Units Per Box	Code No. (REF)
2 ml	Centric	0.1 ml	3.0 ml	100 pcs.	4606701V
5 ml	Centric	0.2 ml	6.0 ml		4606710V
10 ml	Centric	0.5 ml	12.0 ml		4606728V
20 ml	Centric	1.0 ml	24.0 ml		4606736V

Injekt® Luer Duo

2-piece syringes with Luer connector and detached needle



Product Features

- Green plunger
- Highly transparent barrel
- Black graduation
- Integrated plunger backstop (1)
- Graduation extended beyond nominal volume
- Luer connector
- Barrel made of polypropylene
- Plunger made of polyethylene
- Syringe not manufactured with silicone oil, PVC, Latex, DEHP and BPA
- Sterile single packaging
- Box of 100 pcs.
- Syringe with detached needle

User Benefits

- Green plunger for precise dosage
- Highly transparent barrel with black graduation for easy reading
- Safe plunger backstop helps to prevent unintentional plunger withdrawal and the loss of any liquids
- Duo version combines syringe and detached needle in one packaging resulting in less waste compared to single packed products



Injekt® Luer Duo, manufactured according to ISO 7886-1 and ISO 7864

Size	Cone	Graduation	Total Graduated Capacity	Gauge x Length (inch)	Ø x Length	Units Per Box	Code No. (REF)
2 ml	Centric	0.1 ml	3.0 ml	23 G x 1 ¼ "	0.6 x 30 mm	100 pcs.	4645022V
5 ml	Eccentric	0.2 ml	6.0 ml	22 G x 1 ¼ "	0.7 x 30 mm		4645057V
10 ml	Eccentric	0.5 ml	12.0 ml	21 G x 1 ½ "	0.8 x 40 mm		4645103V
20 ml	Eccentric	1.0 ml	24.0 ml	21 G x 1 ½ "	0.8 x 40 mm		4645200V

Injekt®

Packaging design

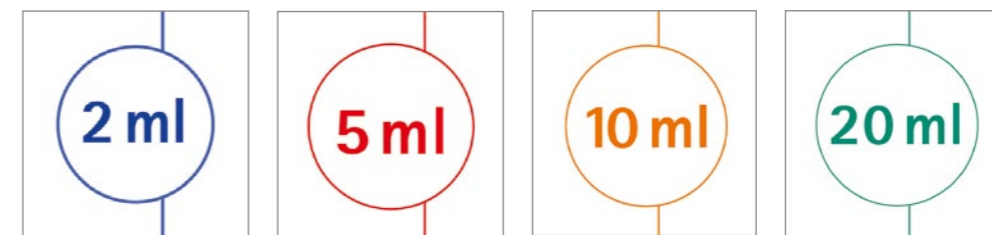

▪ Color-coded packaging for easier differentiation of versions



▪ Product name on all relevant sides for quick orientation

Injekt®-H Luer Solo (Type LDS)

2-piece fine dosage syringes with heparin graduation and Luer connector

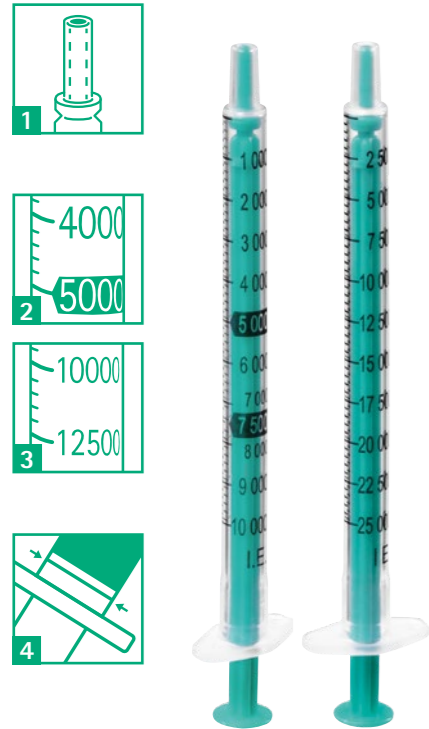

Product Features

- Low Dead Space (LDS):
 - Plunger with displacement spike (1)
 - 200 I.U. graduation for heparin concentrations up to 10000 I.U. (2) or 500 I.U. graduation for concentrations up to 25000 I.U. (3)
 - Additional 0.02 ml graduation
 - Green plunger
 - Highly transparent barrel
- Black graduation
- Integrated plunger backstop (4)
- Luer connector
- Barrel made of polypropylene
- Plunger made of polyethylene
- Not manufactured with silicone oil, PVC, Latex, DEHP and BPA
- Sterile single packaging
- Box of 100 pcs.

User Benefits

- 10000 I.U. and 25000 I.U. heparin/1 ml graduation for precise administration of drugs without converting dosage volumes
- Highly transparent barrel with black graduation and green plunger for easy reading and exact dosing
- Safe plunger backstop helps to prevent unintentional plunger withdrawal and the loss of any liquids
- Type LDS allows for minimal residual volume due to displacement spike

I.U. = International Unit

Note: More detailed information on Low Dead Space syringes can be found on page 27.

Injekt®-H Luer Solo (Type LDS), manufactured according to ISO 7886-1

Size	Cone	Graduation / Scale Value	Total Graduated Capacity	Units Per Box	Code No. (REF)
1 ml	Centric	1.0 ml / 10000 I.U.	1.0 ml	100 pcs.	9166106V
		0.02 ml / 200 I.U.			9166254V
		1.0 ml / 25000 I.U.			
		0.02 ml / 500 I.U.			

Injekt®-F Luer Solo, Injekt®-F Luer Duo (Type LDS)

2-piece fine dosage syringes with Luer connector with and without detached needle

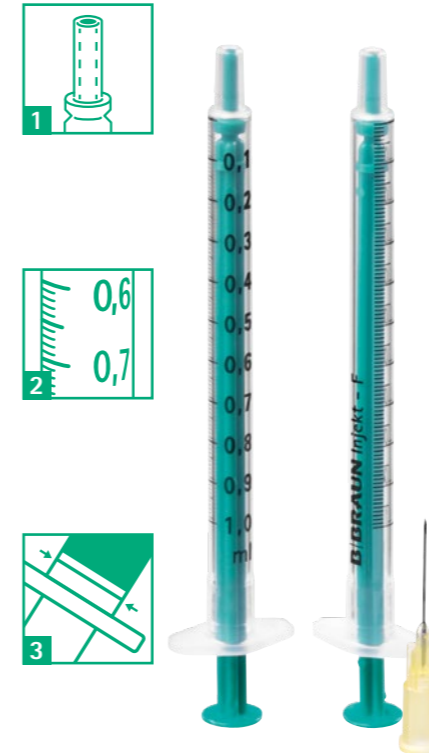

Product Features

- Low Dead Space (LDS):
 - Plunger with displacement spike (1)
 - Fine 0.01 ml graduation (2)
 - Green plunger
 - Highly transparent barrel
 - Black graduation
 - Integrated plunger backstop (3)
 - Luer connector
- Barrel made of polypropylene
- Plunger made of polyethylene
- Syringe not manufactured with silicone oil, PVC, Latex, DEHP and BPA
- Sterile single packaging
- Box of 100 pcs.
- Syringe with and without detached needle

User Benefits

- Fine 0.01 ml graduation for precise dosage of smallest volumes
- Highly transparent barrel with black graduation and green plunger for easy reading and exact dosing
- Safe plunger backstop helps to prevent unintentional plunger withdrawal and the loss of any liquids
- Type LDS allows for minimal residual volume due to displacement spike
- Duo version combines syringe and detached needle in one packaging resulting in less waste compared to single packed products

Note: More detailed information on Low Dead Space syringes can be found on page 27.

Injekt®-F Luer Solo (Type LDS), manufactured according to ISO 7886-1

Size	Cone	Graduation	Total Graduated Capacity	Units Per Box	Code No. (REF)
1 ml	Centric	0.01 ml	1.0 ml	100 pcs.	9166017V

Injekt®-F Luer Duo (Type LDS), manufactured according to ISO 7886-1 and ISO 7864

Size	Cone	Graduation	Total Graduated Capacity	Gauge x Length (inch)	Ø x Length	Units Per Box	Code No. (REF)
1 ml	Centric	0.01 ml	1.0 ml	25 G x 5/8 "	0.5 x 16 mm	100 pcs.	9166033V

3-Piece Syringes and 3-Piece Fine Dosage Syringes

Omnifix®, Omnifix®-F, Omnifix®-H, Omnican® F

With Omnifix®, B. Braun offers a broad range of 3-piece single-use syringes with Luer and Luer Lock connectors in various sizes. In addition fine dosage syringes with Luer and Luer Lock connectors (Type LDS) as well as fine dosage syringes with heparin graduation are included. With Omnican® F the range of 3-piece fine dosage syringes is completed by a version with already integrated needle (Type LDS).



Omnifix® Luer Solo

3-piece syringes with Luer connector



Product Features

- Highly transparent barrel
- High contrast graduation
- Integrated plunger backstop (1)
- Graduation extended beyond nominal volume for 2 ml, 10 ml and 50 ml
- Luer connector
- Barrel and plunger made of polypropylene
- Plunger stopper with double sealing ring made of polyisoprene
- Not manufactured with PVC, Latex, DEHP and BPA
- Sterile single packaging
- Box of 100 pcs.

User Benefits

- Highly transparent barrel with high contrast graduation for easy reading and exact dosing
- Plunger stopper with double sealing ring allows slow aspiration and injection
- Safe plunger backstop helps to prevent unintentional plunger withdrawal and the loss of any liquids

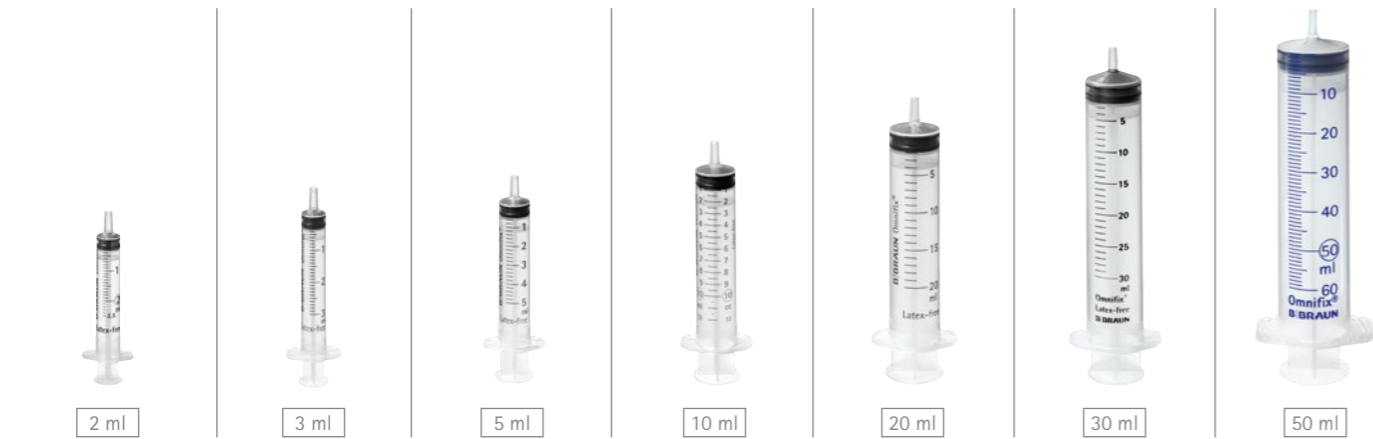

Omnifix® Luer Solo, manufactured according to ISO 7886-1

Size	Cone	Graduation	Total Graduated Capacity	Units Per Box	Code No. (REF)
2 ml	Centric	0.1 ml	2.5 ml	100 pcs.	4616022V
3 ml	Centric	0.1 ml	3.0 ml		4616025V
5 ml	Eccentric	0.2 ml	5.0 ml		4616057V
10 ml	Eccentric	0.5 ml	12.0 ml		4616103V
20 ml	Eccentric	1.0 ml	20.0 ml		4616200V
30 ml	Eccentric	1.0 ml	30.0 ml		4616308F
50 ml	Eccentric	1.0 ml	60.0 ml		4616502F

Omnifix® Luer Lock Solo

3-piece syringes with Luer Lock connector



Product Features

- Highly transparent barrel
- High contrast graduation
- Integrated plunger backstop (1)
- Graduation extended beyond nominal volume for 2 ml, 10 ml and 50 ml
- Luer Lock connector
- Barrel and plunger made of polypropylene
- Plunger stopper with double sealing ring made of polyisoprene
- Not manufactured with PVC, Latex, DEHP and BPA
- Sterile single packaging
- Box of 100 pcs.

User Benefits

- Highly transparent barrel with high contrast graduation for easy reading and exact dosing
- Plunger stopper with double sealing ring allows slow aspiration and injection
- Safe plunger backstop helps to prevent unintentional plunger withdrawal and the loss of any liquids
- Released for using in combination with compatible pump sizes 2 to 50 ml syringes with Luer Lock connector

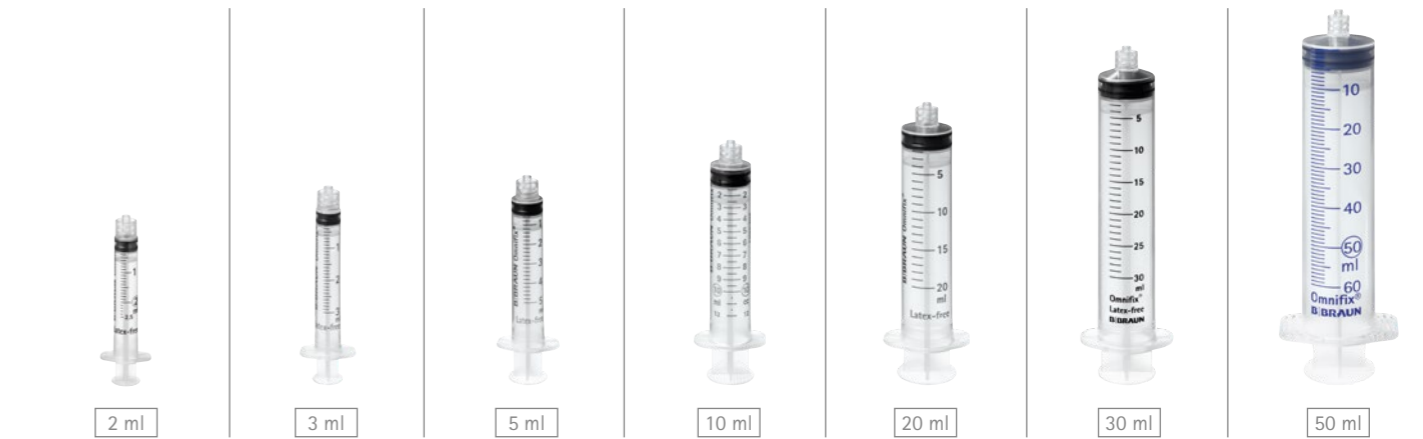

Omnifix® Luer Lock Solo, manufactured according to ISO 7886-1 and ISO 7886-2

Size	Cone	Graduation	Total Graduated Capacity	Units Per Box	Code No. (REF)
2 ml	Centric	0.1 ml	2.5 ml	100 pcs.	4617029V
3 ml	Centric	0.1 ml	3.0 ml		4617022V
5 ml	Centric	0.2 ml	5.0 ml		4617053V
10 ml	Centric	0.5 ml	12.0 ml		4617100V
20 ml	Centric	1.0 ml	20.0 ml		4617207V
30 ml	Centric	1.0 ml	30.0 ml		4617304F
50 ml	Centric	1.0 ml	60.0 ml		4617509F

Omnifix® Luer Duo

3-piece syringes with Luer connector and detached needle



Product Features

- Highly transparent barrel
- High contrast black graduation
- Integrated plunger backstop (1)
- Graduation extended beyond nominal volume for 2 ml and 10 ml
- Luer connector
- Barrel and plunger made of polypropylene
- Plunger stopper with double sealing ring made of polyisoprene
- Not manufactured with PVC, Latex, DEHP and BPA
- Sterile single packaging
- Box of 100 pcs.
- Syringe with detached needle

User Benefits

- Highly transparent barrel with high contrast black graduation for easy reading and exact dosing
- Plunger stopper with double sealing ring allows slow aspiration and injection as well as precise dosing of small volumes
- Safe plunger backstop helps to prevent unintentional plunger withdrawal and the loss of any liquids
- Duo version combines syringe and detached needle in one packaging resulting in less waste compared to single packed products



Omnifix® Luer Duo, manufactured according to ISO 7886-1 and ISO 7864

Size	Cone	Graduation	Total Graduated Capacity	Gauge x Length (inch)	Ø x Length	Units Per Box	Code No. (REF)
2 ml	Centric	0.1 ml	2.5 ml	23 G x 1 ¼ "	0.6 x 30 mm	100 pcs.	4643100V
3 ml	Centric	0.1 ml	3.0 ml	23 G x 1 ¼ "	0.6 x 30 mm		4643102V
5 ml	Eccentric	0.2 ml	5.0 ml	22 G x 1 ¼ "	0.7 x 30 mm		4643119V
10 ml	Eccentric	0.5 ml	12.0 ml	21 G x 1 ½ "	0.8 x 40 mm		4643127V
20 ml	Eccentric	1.0 ml	20.0 ml	21 G x 1 ½ "	0.8 x 40 mm		4643135V

Omnifix®

Packaging design



- Color-coded packaging for easier differentiation of versions



- Product name on all relevant sides for quick orientation

Omnifix®-H Luer Solo

3-piece fine dosage syringes with heparin graduation and Luer connector

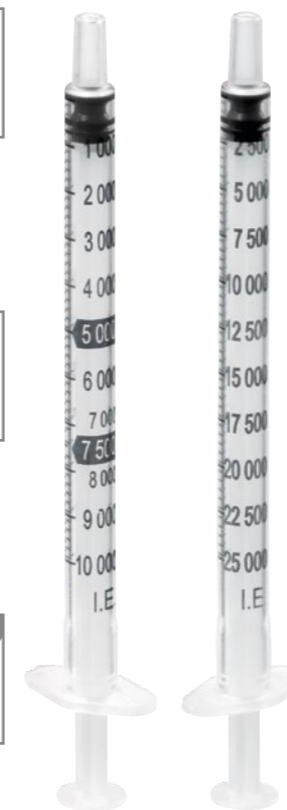
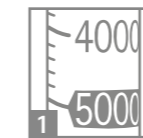

Product Features

- 200 I.U. graduation for heparin concentrations up to 10 000 I.U.s (1) or 500 I.U. graduation for concentrations up to 25 000 I.U.s (2)
- Additional fine 0.02 ml graduation
- Highly transparent barrel
- High contrast black graduation
- Integrated plunger backstop (3)
- Barrel made of polypropylene
- Plunger made of polystyrene
- Plunger stopper with double sealing ring made of polyisoprene
- Not manufactured with PVC, Latex, DEHP and BPA
- Sterile single packaging
- Box of 100 pcs.

User Benefits

- 10 000 I.U./1 ml or 25 000 I.U./1 ml heparin graduation for precise administration of drugs without converting dosage volumes
- Highly transparent barrel with high contrast black graduation for easy reading and exact dosing
- Plunger stopper with double sealing ring allows slow aspiration and injection
- Safe plunger backstop helps to prevent unintentional plunger withdrawal and the loss of any liquids

I.U. = International Unit

Omnifix®-H Luer Solo, manufactured according to ISO 7886-1

Size	Cone	Graduation/Scale Value	Total Graduated Capacity	Units Per Box	Code No. (REF)
1 ml	Centric	1.0 ml/10 000 I.U.	1.0 ml	100 pcs.	9162909V
		0.02 ml/200 I.U.			
		1.0 ml/25 000 I.U.			9162607V
		0.02 ml/500 I.U.			

Omnifix®-F Luer Solo, Omnifix®-F Luer Duo

3-piece fine dosage syringes with Luer connector with and without detached needle

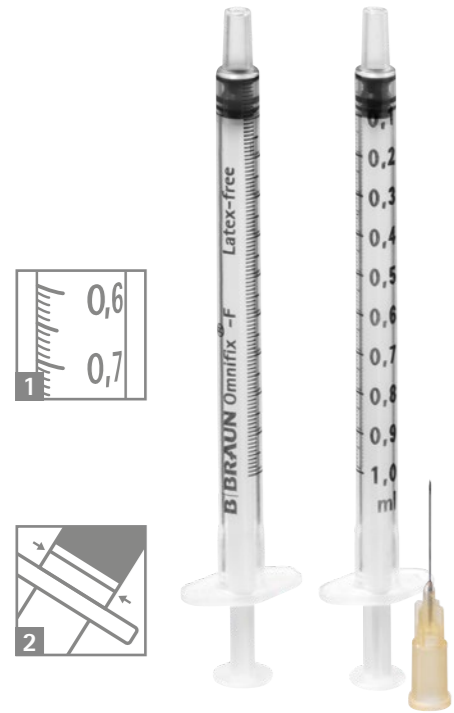

Product Features

- Fine 0.01 ml graduation (1)
- Highly transparent barrel
- High contrast black graduation
- Integrated plunger backstop (2)
- Luer connector
- Barrel made of polypropylene
- Plunger made of polystyrene
- Plunger stopper with double sealing ring made of polyisoprene
- Not manufactured with PVC, Latex, DEHP and BPA
- Sterile single packaging
- Box of 100 pcs.
- Syringe with and without detached needle

User Benefits

- Fine 0.01 ml graduation for precise dosage of smallest volumes
- Highly transparent barrel with high contrast black graduation for easy reading and exact dosing
- Plunger stopper with double sealing ring allows slow aspiration and injection
- Safe plunger backstop helps to prevent unintentional plunger withdrawal and the loss of any liquids
- Duo version combines syringe and detached needle in one packaging resulting in less waste compared to single packed products

Omnifix®-F Luer Solo, manufactured according to ISO 7886-1

Size	Cone	Graduation	Total Graduated Capacity	Units Per Box	Code No. (REF)
1 ml	Centric	0.01 ml	1.0 ml	100 pcs.	9161406V

Omnifix®-F Luer Duo, manufactured according to ISO 7886-1 and ISO 7864

Size	Cone	Graduation	Total Graduated Capacity	Gauge x Length (inch)	Ø x Length	Units Per Box	Code No. (REF)
1 ml	Centric	0.01 ml	1.0 ml	25 G x 5/8"	0.5 x 16 mm	100 pcs.	9161465V

Low Dead Space Syringes

Definition and different types of Low Dead Space (LDS) syringes

What is Dead Space?

The area in which fluid remains after fully inserting the plunger. The remaining fluid is also called residual volume.

Differences between the Dead Space of syringes

Standard 3-piece syringe with detachable needle (Omnifix®-F Luer)



Dead space in the syringe cone and needle hub.

3-piece Low Dead Space syringe with detachable needle (Omnifix®-F Luer Lock (Type LDS))



Low dead space due to displacement spike at the tip of the plunger stopper that reduces the residual volume in the syringe cone.

2-piece Low Dead Space syringe with detachable needle (Injekt®-F Luer (Type LDS))



Low dead space due to displacement spike at the tip of the plunger that reduces the residual volume in the syringe cone.

3-piece syringe with integrated needle (Omnican®)



Lowest dead space due to integrated needle. Syringe has no cone nor separate needle hub where fluid can remain.

With both, standard and Low Dead Space syringes, the same amount of fluid is delivered, regardless of the amount of residual volume.

User Benefits

- Higher number of doses that can be extracted out of a multi-dose vial compared to a standard syringe
- Reduction of drug loss
- Avoidance of additional costs
- No change in current clinical practice when using Low Dead Space syringes

Omnifix®-F Luer Lock Solo (Type LDS)

3-piece fine dosage syringes with Luer Lock connector

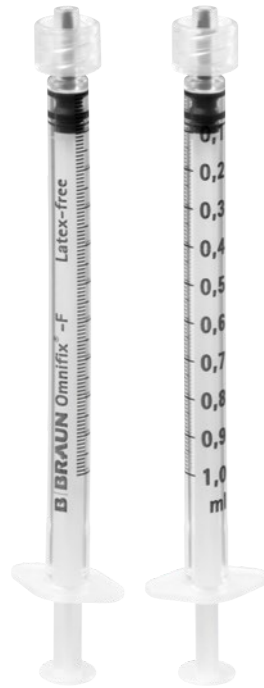
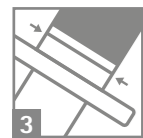
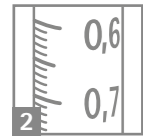
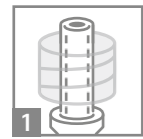

Product Features

- Low Dead Space (LDS):
 - Plunger with displacement spike (1)
 - Fine 0.01 ml graduation (2)
 - Highly transparent barrel
 - High contrast black graduation
 - Integrated plunger backstop (3)
 - Luer Lock connector
 - Barrel made of polypropylene
- Plunger made of polystyrene
- Plunger stopper with double sealing ring made of polyisoprene
- Not manufactured with PVC, Latex, DEHP and BPA
- Sterile single packaging
- Box of 100 pcs.

User Benefits

- Fine 0.01 ml graduation for precise dosage of smallest volumes
- Highly transparent barrel with high contrast black graduation for easy reading
- Plunger stopper with double sealing ring allows slow aspiration and injection
- Safe plunger backstop helps to prevent unintentional plunger withdrawal and the loss of any liquids
- Type LDS allows for minimal residual volume due to displacement spike

Note: More detailed information on Low Dead Space syringes can be found on page 27.

Omnifix®-F Luer Lock Solo (Type LDS), manufactured according to ISO 7886-1

Size	Cone	Graduation	Total Graduated Capacity	Units Per Box	Code No. (REF)
1 ml	Centric	0.01 ml	1.0 ml	100 pcs.	9167006V

Omnican® F (Type LDS)

3-piece fine dosage syringes with integrated needle

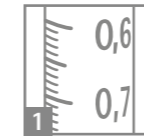

Product Features

- Integrated needle
- Fine 0.01 ml graduation (1)
- Transparent protection cap
- Highly transparent barrel
- High contrast black graduation
- Integrated plunger backstop (2)
- Barrel made of polypropylene
- Plunger made of polystyrene
- Plunger stopper with double sealing ring made of polyisoprene
- Reduced residual volume
- Not manufactured with PVC, Latex, DEHP and BPA
- Sterile single packaging
- Box of 100 pcs.

User Benefits

- Lowest dead space syringe within the B. Braun syringe portfolio: reduced drug loss due to integrated fine needle
- Fine 0.01 ml graduation for precise dosage of smallest volumes
- Highly transparent barrel with high contrast black graduation for easy reading
- Safe plunger backstop helps to prevent unintentional plunger withdrawal and the loss of any liquids

Note: More detailed information on Low Dead Space syringes can be found on page 27.

Omnican® F (Type LDS) with integrated needle, manufactured according to ISO 7886-1, ISO 7864 and ISO 8537

Size	Cone	Graduation	Total Graduated Capacity	Gauge x Length (inch)	Ø x Length	Units Per Box	Code No. (REF)
1 ml	Centric	0.01 ml	1.0 ml	30 G x 1/2 "	0.3 x 12 mm	100 pcs.	9161502S

Precise Aspiration & Injection with B. Braun Syringes

Handling recommendation

For precise aspiration and injection as well as for the exact dosing of smallest volumes please refer to the following handling recommendation:

- 1** Withdrawal of required fluid amount into the syringe (e.g. 0.5 ml – fiducial line needs to align with the 0.5 ml graduation line)
- 2** Injection of fluid into e.g. an admixture vial or directly into the patient by pushing the plunger smooth and slowly (plunger needs to be fully depressed to the zero line in order to inject 0.5 ml fluid)

The handling recommendation is valid for both standard and Low Dead Space syringes. The same amount of fluid is delivered independently of the amount of residual volume. Therefore, no change in handling practice is required when using either standard or Low Dead Space syringes.

3-piece insulin syringes with integrated needle (Omnican®)

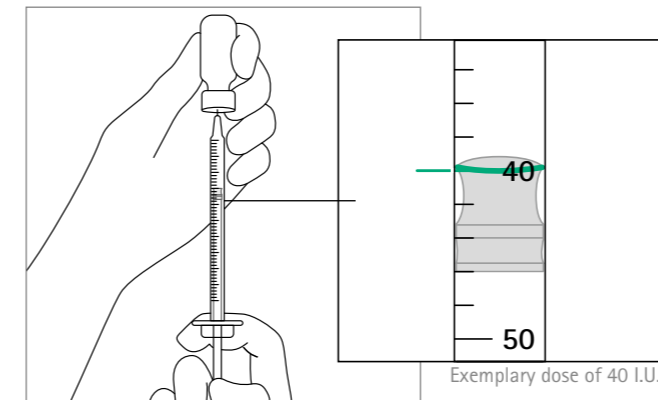

3-piece fine dosage syringes with heparin graduation (Omnifix®-H Luer Solo)

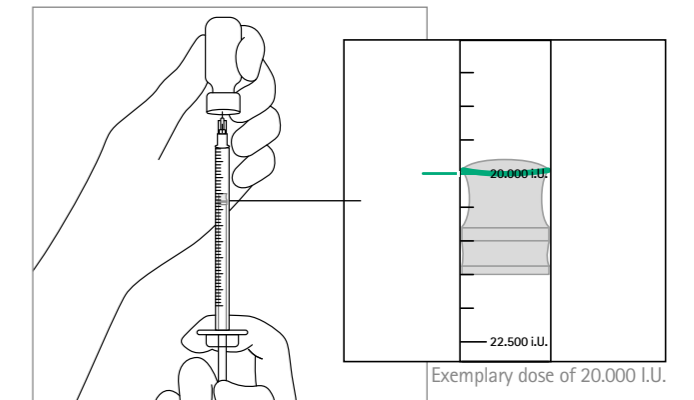

3-piece fine dosage syringes (Omnican® F, Omnifix®-F)

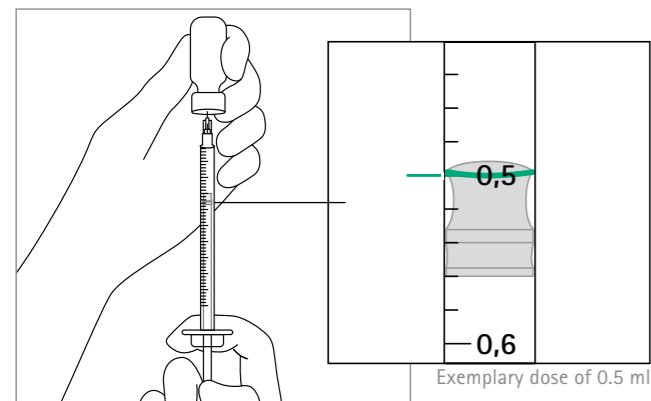

3-piece fine dosage syringes (Type LDS) (Omnifix®-F Luer Lock Solo)

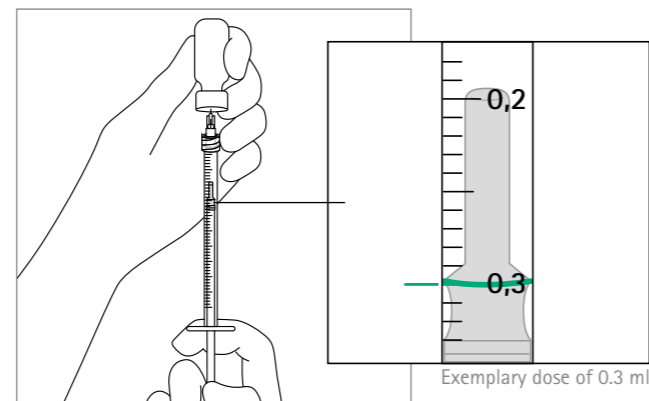

2-piece fine dosage syringes (Type LDS) (Injekt®-F Luer Solo / Duo)

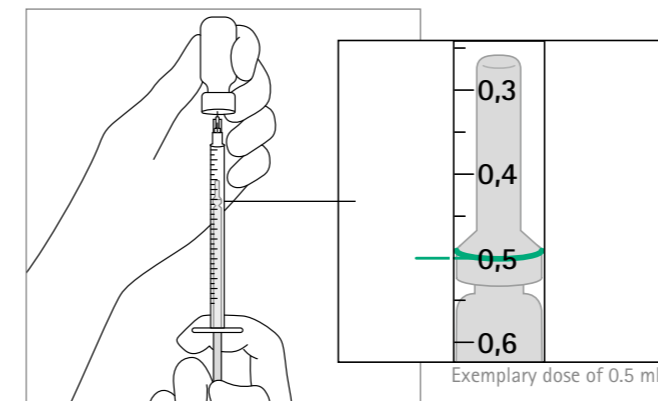

Irrigation Syringes

3-piece syringes for irrigation purposes



Omnifix® Irrigation Syringe

3-piece syringe with catheter tip

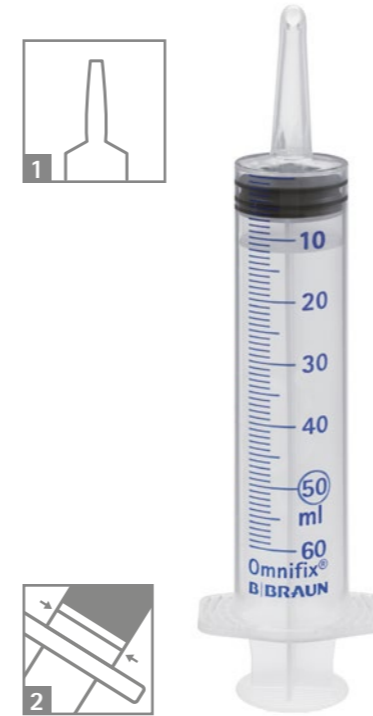

Product Features

- Highly transparent barrel
- High contrast graduation
- Catheter tip (1)
- Integrated plunger backstop (2)
- Graduation extended beyond nominal volume
- Barrel and plunger made of polypropylene
- Plunger stopper with double sealing ring made of polyisoprene
- Not manufactured with PVC, Latex, DEHP and BPA
- Sterile single packaging
- Box of 100 pcs.

User Benefits

- Highly transparent barrel with high contrast graduation for easy reading and exact dosing
- Plunger stopper with double sealing ring allows slow aspiration and injection
- Safe plunger backstop helps to prevent unintentional plunger withdrawal and the loss of any liquids

Size	Cone	Graduation	Total Graduated Capacity	Units Per Box	Code No. (REF)
50 ml	Centric	1 ml	60 ml	100 pcs.	4613503F

SOL-M™ Catheter Tip Syringe without Needle

3-piece syringe with catheter tip and luer adapter

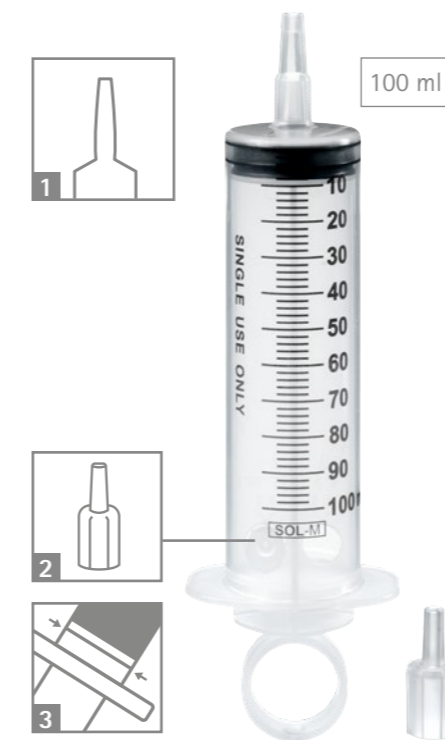

Product Features

- Irrigation syringe with centric catheter tip (1) and Luer adapter (2)
- Black graduation
- Integrated plunger backstop (3)
- Barrel and plunger made of polypropylene
- Plunger stopper with double sealing ring made of polyisoprene
- Not manufactured with PVC, PHT, Latex, DEHP and BPA
- Sterile single packaging
- Box of 30 pcs.

User Benefits

- Highly transparent barrel
- Silicone lubrication ensures smooth plunger movement
- Safe plunger backstop helps to prevent accidental plunger withdrawal
- Large and stable finger grip ensures stability and comfort during injection
- Luer adapter allows filling the syringe from sterile solutions using a standard Luer connection

SOL-M™ Catheter Tip Syringe without needle, manufactured according to ISO 7886-1

Product	Size	Cone	Graduation	Total Graduated Capacity	Units Per Box	Code No. (REF)
SOL-M™ Catheter Tip Syringe without needle (with Luer adapter)	100 ml	Centric	2 ml	100 ml	30 pcs.	180100CT

Original Perfusor® Syringe

3-piece syringes for use with Perfusor® syringe pumps



Product Features

- Highly transparent barrel
- High contrast graduation
- Integrated plunger backstop (1)
- Barrel and plunger made of polypropylene
- Luer Lock connector
- Not manufactured with PVC, Latex and DEHP
- Sterile single packaging
- Plunger stopper with double sealing ring made of bromobutyl (20 ml) and polyisoprene (50 ml)
- 20 ml with detached needle and 50 ml with detachable needle

User Benefits

- Released to be used for infusions by compatible infusion pumps
- High contrast graduation for easy reading
- Versions with and without aspiration or filter needle
- Plunger stopper with double sealing ring allows slow aspiration and injection
- Safe plunger backstop helps to prevent unintentional plunger withdrawal
- UV-protect syringe, 50 ml (orange colored barrel) for light sensitive medications



Original Perfusor® Syringe 20 ml, manufactured according to ISO 7886-1 and ISO 7886-2

Description	Aspiration needle	Size	Cone	Graduation	Total Graduated Capacity	Units Per Box	Code No. (REF)
Without aspiration needle	-	20 ml	Centric	1.0 ml	20 ml	50 pcs.	8728615
Aspiration needle*	14 G x 30 mm	20 ml					8728623

Original Perfusor® Syringe 50 ml, manufactured according to ISO 7886-1 and ISO 7886-2

Description	Aspiration needle	Size	Cone	Graduation	Total Graduated Capacity	Units Per Box	Code No. (REF)
Without aspiration needle	-	50 ml	Centric	1.0 ml	50 ml	100 pcs.	8728844F-06
Aspiration needle	14 G x 30 mm	50 ml					8728810F-06
Aspiration needle with 15 µm particle filter	14 G x 28 mm	50 ml					8728852F-06
Aspiration needle with 15 µm particle filter, light protection up to 520 nm	14 G x 28 mm	50 ml					8728861F-06

* Aspiration needle is detached in the syringe blister packaging

3-Piece Syringes & Accessories for Neuraxial and Regional Anesthesia

Omnifix®, Original Perfusor® Syringes & Closure Cap (Type NRFit®)



Medical device connectors for Neuraxial & Regional Anesthesia applications are changing to meet international design standards.

Medication errors during Regional Anesthesia procedures

The universally compatible Luer connector has been identified as a key element in 'wrong route' medication errors. Luer connectors are widely used for delivery of infusions. Literature shows that any patient having multiple access systems in place are exposed to higher risks of misconnections.¹

The increasing sensitivity to medication errors in clinical settings is visible in an increasing number of publications on this subject in Pubmed between 2000 and 2014 (Fig. 1).

Figure 1

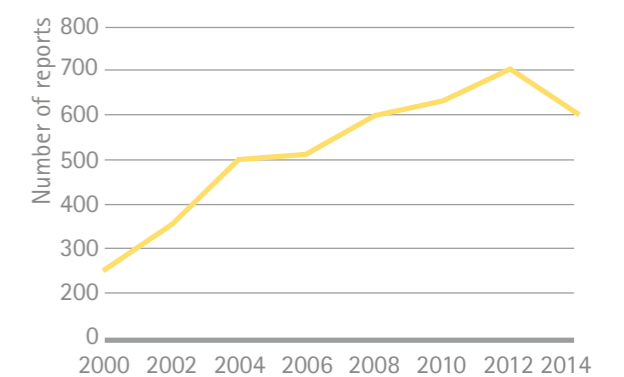

Enhancing patient safety with NRFit®

To reduce the risk of wrong route medication errors the International Organization for Standardization (ISO) has developed standards for small-bore connectors, one being in the field of Neuraxial and Regional Anesthesia (ISO 80369-6). The name that will be used to identify devices that comply with the ISO 80369-6 standard is:

NRFit®

ISO 80369-6 in detail

The ISO Standard 'specifies requirements for small-bore connectors intended to be used for connections in Neuraxial applications. Neuraxial applications involve the use of medical devices intended to administer medications to neuraxial sites, wound infiltration anesthesia delivery, and other Regional Anesthesia procedures or to monitor or remove cerebro-spinal fluid for therapeutic or diagnostic purposes.'²

Literature

1. Kress R. Townley, Jason Lane, Robyn Packer, and Rajnish K. Gupta. Unintentional Infusion of Phenylephrine into the Epidural Space. A&A Case Rep. 2016 Mar 1; 6(5):124-6
2. <https://www.iso.org/standard/50734.html> (2017-05-23)

Omnifix® Slip (Type NRFit®), Omnifix®-F Slip (Type NRFit® and LDS)

3-piece syringes and 3-piece fine dosage syringes (Type LDS) with NRFit® Slip connector for neuraxial and regional anesthesia applications

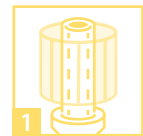

Product Features

- 1 ml: Plunger with displacement spike (1)
- Yellow plunger
- Highly transparent barrel
- High contrast black graduation
- Barrel and plunger made of polypropylene
- 1 ml: Plunger made of polystyrene
- NRFit® Slip connector
- Not manufactured with PVC, Latex and DEHP
- Sterile single packaging
- Box of 100 pcs.

User Benefits

- Designed to reduce risks of wrong route medication errors from the very beginning in Neuraxial and Regional Anesthesia procedures
- The yellow product color coding of syringes helps to visually differentiate between regular and NRFit® dedicated equipment
- High contrast black graduation for easy reading
- Safe plunger backstop helps to prevent unintentional plunger withdrawal
- 1 ml: Type LDS allows for minimal residual volume due to displacement spike

Note: More detailed information on Low Dead Space syringes can be found on page 27.

Omnifix® Lock (Type NRFit®)

3-piece syringes with NRFit® Lock connector for neuraxial and regional anesthesia applications



Product Features

- Yellow plunger
- Highly transparent barrel
- High contrast black graduation
- Barrel and plunger made of polypropylene
- Plunger stopper with double sealing ring made of polyisoprene
- NRFit® Lock connector
- Not manufactured with PVC, Latex and DEHP
- Sterile single packaging
- Box of 100 pcs.

User Benefits

- Designed to reduce risks of wrong route medication errors from the very beginning in Neuraxial and Regional Anesthesia procedures
- The yellow product color coding of syringes helps to visually differentiate between regular and NRFit® dedicated equipment
- Omnifix® 3-20 ml and 50 ml Lock versions can be used in combination with compatible syringe pumps
- High contrast black graduation for easy reading
- Safe plunger backstop helps to prevent unintentional plunger withdrawal



Omnifix® Slip (Type NRFit®), manufactured according to ISO 7886-1 and ISO 80369-6

Size	Cone	Graduation	Total Graduated Capacity	Units Per Box	Code No. (REF)
1 ml	Centric	0.010 ml	1.0 ml	100 pcs.	9164001
3 ml	Centric	0.1 ml	3.0 ml		4616003
5 ml	Centric	0.2 ml	5.0 ml		4616005
10 ml	Centric	0.5 ml	10.0 ml		4616014
20 ml	Centric	1.0 ml	20.0 ml		4616021

Omnifix® Lock (Type NRFit®), manufactured according to ISO 7886-1, ISO 7886-2 and ISO 80369-6

Size	Cone	Graduation	Total Graduated Capacity	Units Per Box	Code No. (REF)
3 ml	Centric	0.1 ml	3.0 ml	100 pcs.	4617003
5 ml	Centric	0.2 ml	5.0 ml		4617006
10 ml	Centric	0.5 ml	10.0 ml		4617014
20 ml	Centric	1.0 ml	20.0 ml		4617021
50 ml	Centric	1.0 ml	60.0 ml		4617508F-01

Original Perfusor® Syringe (Type NRFit®, Lock) and Closure Cap (Type NRFit®)

3-piece syringes & accessories with NRFit® connector for neuraxial and regional anesthesia



50 ml

Original Perfusor® Syringe 50 ml (Type NRFit®, Lock), manufactured according to ISO 7886-1, ISO 7886-2 and ISO 80369-6

Size	Cone	Graduation	Total Graduated Capacity	Units Per Box	Code No. (REF)
50 ml	Centric	1.0 ml	50.0 ml	100 pcs.	8728845F-01



Closure Cap NRFit®, manufactured according to ISO 80369-6

Description	Units Per Box	Code No. (REF)
Closure Cap NRFit®	100 pcs.	4517501N

NRFit®

NRFit® Trademark Registration Information

NRFit® is a federally registered trademark of GEDSA in multiple jurisdictions throughout the world. Used with permission.



Perifix® LOR Syringe (Type NRFit®)

3-piece syringes with NRFit® connector for the Loss of Resistance (LOR) technique in epidural anesthesia



Product Features

- Yellow plunger
- Highly transparent barrel
- High contrast black graduation
- Barrel and plunger made of polypropylene
- Plunger stopper made of TPE (Thermoplastic elastomer)
- NRFit® Slip and NRFit® Lock connector
- Not manufactured with PVC, Latex and DEHP
- Sterile single packaging
- Box of 25 pcs.

User Benefits

- Designed to reduce risks of wrong route medication errors from the very beginning in Neuraxial and Regional Anesthesia procedures
- The yellow product color coding of syringes helps to visually differentiate between regular and NRFit® dedicated equipment
- Clear identification of epidural space
- Suitable for air and saline application
- Easy-glide plunger with excellent glide characteristics
- Parabolic graduation markings help to prevent confusion with conventional syringes



Perifix® LOR Syringes (Type NRFit®), manufactured according to ISO 7886-1 and ISO 80369-6

Description	Size	Cone	Total Graduated Capacity	Units Per Box	Code No. (REF)
Perifix® LOR, NRFit® Slip	8 ml	Centric	8.0 ml	25 pcs.	4637110
Perifix® LOR, NRFit® Lock					4638110

In order to obtain more information about our B. Braun products with NRFit® connectors, simply scan the QR code with the camera of your smartphone and a suitable reader application and get to the website.



Perifix® LOR Syringe

3-piece syringes for the Loss of Resistance (LOR) technique in epidural anesthesia



Product Features

- Green plunger
- Barrel and plunger made of polypropylene
- Plunger stopper made of TPE (Thermoplastic elastomer)
- Luer and Luer Lock connector
- Not manufactured with PVC, Latex and DEHP
- Sterile single packaging
- Box of 25 pcs.

User Benefits

- Clear identification of epidural space
- Suitable for air and saline application
- Easy-glide plunger with excellent glide characteristics
- Parabolic graduation markings help to prevent confusion with conventional syringes



Perifix® LOR Syringes, manufactured according to ISO 7886-1

Description	Size	Cone	Total Graduated Capacity	Units Per Box	Code No. (REF)
Perifix® LOR, Luer	8 ml	Centric	8.0 ml	25 pcs.	4637100
Perifix® LOR, Luer Lock					4638107

Exadoral®, Exadoral® (Type LDS)

2-piece syringes for oral applications



Product Features

- 1 ml: Plunger with displacement spike (1)
- Purple plunger
- Centric oral cone
- Highly transparent barrel
- High contrast black graduation
- Non-luer tip design
- Integrated plunger backstop (2)
- Barrel made of polypropylene
- Plunger made of polyethylene
- Not manufactured with silicone oil, PVC, Latex and DEHP
- Sterile single packaging
- Box of 100 pcs.

User Benefits

- Purple plunger for visual differentiation from conventional and NRFit® syringes
- Due to a centric cone design, the Exadoral® syringes are not compatible with intravenous connectors help to prevent inadvertent intravenous connection
- Non-luer tip design
- For withdrawal of liquid medication
- High contrast black graduation for easy reading and precise dosing
- 1 ml: Type LDS allows for minimal residual volume due to displacement spike

Note: More detailed information on Low Dead Space syringes can be found on page 27.

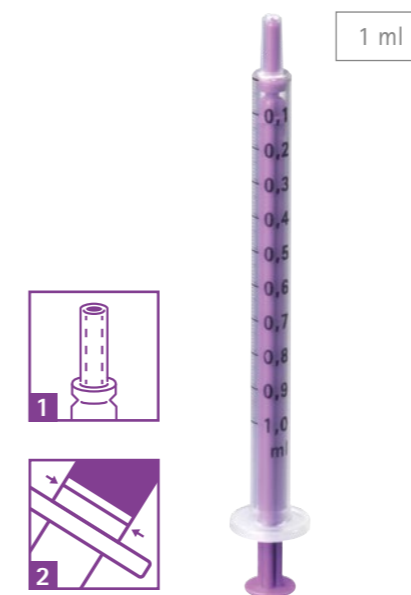

Exadoral®, Exadoral® (Type LDS), manufactured according to ISO 7886-1, syringes with oral connector (non-luer tip design)

Size	Cone	Graduation	Total Graduated Capacity	Units Per Box	Code No. (REF)
1 ml	Oral connector, centric	0.01 ml	1.0 ml	100 pcs.	4608661
2 ml	Oral connector, centric	0.10 ml	3.0 ml		4608662
5 ml	Oral connector, centric	0.20 ml	5.0 ml		4608660
10 ml	Oral connector, centric	0.50 ml	10.0 ml		4608667
20 ml	Oral connector, centric	1.00 ml	20.0 ml		4608663

Exadoral® Straws and Bottle Adapter

Accessories



Exadoral® straws and bottle adapter, manufactured according to ISO 80369-6

Description	Units Per Box	Code No. (REF)
Exadoral® Straw, 10 cm	5 pcs.	4608670
Exadoral® Straw, 17 cm		4608671
Exadoral® Bottle Adapter, ø 24 mm		4608672
Exadoral® Bottle Adapter, ø 28 mm		4608673

Enteral Syringes & Devices (Type ENFit®)

3-piece syringes & devices with ENFit® connector for enteral applications



The international standard design for enteral application systems

B. Braun has a long experience in providing innovative solutions for clinical nutrition. As a leader in safe infusion therapy, B. Braun is continuously making efforts to improve safety in clinical nutrition application. Our comprehensive portfolio offers optimized support for the nutrition therapy, including both enteral and parenteral applications, while reducing the risk of misconnections between enteral and parenteral routes.

With the introduction of the ENPlus connector at the nutrition end of application sets (ISO 18250), B. Braun has made an important step to improve safety of enteral and parenteral applications.

Enhancing Patient Safety for Enteral Nutrition

To enhance patient safety, B. Braun has been collaborating with the Global Enteral Device Supplier Association (GEDSA) to support the introduction and adoption of a new ISO standard for small-bore connectors:

ENFit®

The ENFit® standard design for enteral application systems is defined in the ISO 80369-3 series, establishing ENFit® as the international standard design for enteral patient-access connections.

The ENFit® connector system is specifically designed for enteral nutrition administration devices at the patient



end, promoting enhanced patient safety and helps to prevent unintentional connections between enteral and intravenous systems. The female ENFit® connector at the patient-end of the administration set will only connect to the male patient-access feeding tube port. Enteral syringes with a female ENFit® connector will only fit to second access stopcocks on application sets or feeding tubes with a male ENFit® connector.

Whereas the ENFit® standard connectors will replace the existing enteral connectors at the patient end of enteral application sets, the ENPlus connection system will remain the design standard at the nutrition end. B. Braun will provide enteral administration sets featuring both connection systems ENPlus and ENFit®.

Enteral Syringes (Type ENFit®)

3-piece syringes with ENFit® connector for enteral applications



Product Features

- Enteral syringe with female ENFit® connector
- Purple plunger
- Highly transparent barrel
- High contrast black graduation
- Integrated plunger backstop (1)
- Only connectable to male ENFit® connector (IV incompatible)
- Barrel and plunger made of polypropylene
- Not manufactured with PVC, Latex, DEHP and BPA
- Sterile single packaging

User Benefits

- Purple plunger for visual differentiation from conventional and NRFit® syringes
- Purple color coding allows faster identification of enteral devices
- Dedicated enteral connectors to reduce risk of misconnections
- „Lock and Key“ feature ensures secure connection
- Highly transparent barrel with high contrast black graduation for easy reading and precise dosing
- Low dose tip on the 1 ml, 2.5 ml and 5 ml syringe sizes

Enteral Straw and Syringe Cap (Type ENFit®)

Accessories



Enteral straws and syringe caps (Type ENFit®), manufactured according to ISO 80369-3

Description	Units Per Box	Code No. (REF)
Enteral Straw with ENFit® connector - 10 cm	5 pcs.	4616009
Enteral Syringe Cap with ENFit® connector	300 pcs.	4616020



Enteral syringes (Type ENFit®), manufactured according to ISO 7886-1 and ISO 80369-3

Size	Cone	Graduation	Total Graduated Capacity	Units Per Box	Code No. (REF)
1 ml	Centric	0.01 ml	1.0 ml	200 pcs.	4616024-01
2.5 ml	Eccentric	0.10 ml	2.5 ml		4616025-01
5 ml	Eccentric	0.10 ml	5.0 ml		4616026-01
10 ml	Eccentric	0.10 ml	10.0 ml	100 pcs.	4616027-01
20 ml	Eccentric	1.00 ml	20.0 ml		4616028-01
60 ml	Eccentric	1.00 ml	60.0 ml		4616029-01

ENFit®

ENFit® Trademark Registration Information

ENFit® is a trademark of GEDSA. Used with permission.

2-Piece and 3-Piece Insulin Syringes

Injekt[®], Omnifix[®] and Omnican[®] insulin syringes

For insulin applications, B. Braun offers a wide range of 2-piece and 3-piece insulin syringes. The range includes 2-piece and 3-piece insulin syringes with and without detached needle as well as 3-piece insulin syringes with integrated needle.



Injekt® 40 (Type LDS)

2-piece insulin syringes for U-40 insulin with Luer connector



Product Features

- Low Dead Space (LDS):
 - Plunger with displacement spike (1)
- Fine 1 I.U. graduation for U-40 insulin (2)
- Green plunger
- Highly transparent barrel
- Red graduation
- Integrated plunger backstop (3)
- Barrel made of polypropylene
- Plunger made of polyethylene
- Versions with and without detached needle
- Syringe not manufactured with silicone oil, PVC, Latex, DEHP and BPA
- Sterile single packaging
- Box of 100 pcs.

User Benefits

- Highly transparent barrel with red graduation and green plunger for easy reading and exact dosing
- Highly transparent barrel to make sure that air bubbles are easily identified
- Safe plunger backstop helps to prevent unintentional plunger withdrawal and the loss of any liquids
- Type LDS allows for minimal residual volume due to displacement spike
- Duo version combines syringe and detached needle in one packaging resulting in less waste compared to single packed products

I.U. = International Unit

Note: More detailed information on Low Dead Space syringes can be found on page 27.

Injekt® 40 for U-40 insulin with Luer connector (Type LDS), manufactured according to ISO 8537 and ISO 7864

U-40

Size	Graduation / Scale Value	Total Graduated Capacity	Gauge x Length (inch)	Ø x Length	Units Per Box	Code No. (REF)
1 ml	for insulin U-40 with scale value 1 I.U.	1.0 ml	-	-	100 pcs.	9166408V
1 ml	for insulin U-40 with scale value 1 I.U.	1.0 ml	26 G x ½ "	0.45 x 12 mm		9166432V

Omnifix® 40, Omnifix® 100

3-piece insulin syringes for U-40 or U-100 insulin with Luer connector

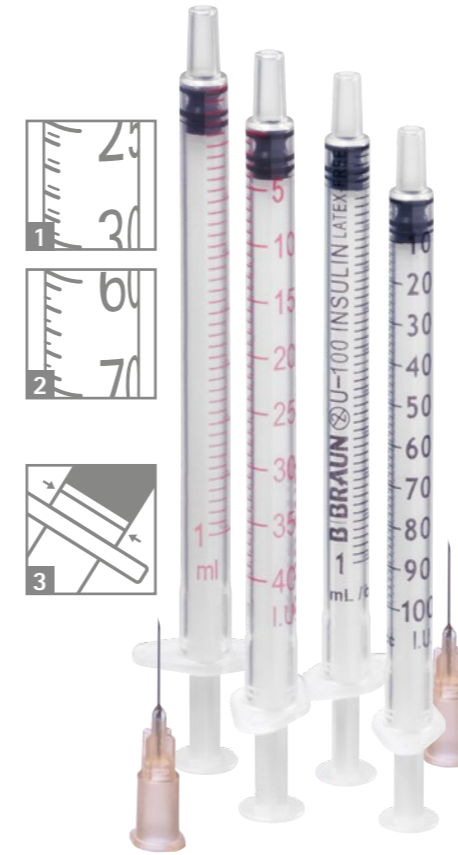

Product Features

- Fine 1 I.U. graduation for U-40 insulin (Omnifix® 40) (1) and 2 I.U. graduation for U-100 insulin (Omnifix® 100) (2)
- Highly transparent barrel
- High contrast graduation
- Integrated plunger backstop (3)
- Plunger stopper with double sealing ring made of polyisoprene
- Barrel made of polypropylene
- Plunger made of polystyrene
- Versions with and without detached needle
- Not manufactured with Latex, PVC, DEHP and BPA
- Sterile single packaging
- Box of 100 pcs.

User Benefits

- Highly transparent barrel with high-contrast graduation for easy reading and exact dosing
- Highly transparent barrel to make sure that air bubbles are easily identified
- Safe plunger backstop helps to prevent unintentional plunger withdrawal and the loss of any liquids
- Duo version combines syringe and detached needle in one packaging resulting in less waste compared to single packed products

I.U. = International Unit

Omnifix® 40 for U-40 insulin with Luer connector, manufactured according to ISO 8537 and ISO 7864

U-40

Size	Graduation / Scale Value	Total Graduated Capacity	Gauge x Length (inch)	Ø x Length	Units Per Box	Code No. (REF)
1 ml	for insulin U-40 with scale value 1 I.U.	1.0 ml	-	-	100 pcs.	9161309V
1 ml	for insulin U-40 with scale value 1 I.U.	1.0 ml	26 G x ½ "	0.45 x 12 mm		9161333V

Omnifix® 100 for U-100 insulin with Luer connector, manufactured according to ISO 8537 and ISO 7864

U-100

Size	Graduation / Scale Value	Total Graduated Capacity	Gauge x Length (inch)	Ø x Length	Units Per Box	Code No. (REF)
1 ml	for insulin U-100 with scale value 2 I.U.	1.0 ml	-	-	100 pcs.	9161708V
1 ml	for insulin U-100 with scale value 2 I.U.	1.0 ml	26 G x ½ "	0.45 x 12 mm		9161376V

Omnican® 20/40, Omnican® 50/100 (Type LDS)

3-piece insulin syringes for U-40 or U-100 insulin with integrated needle

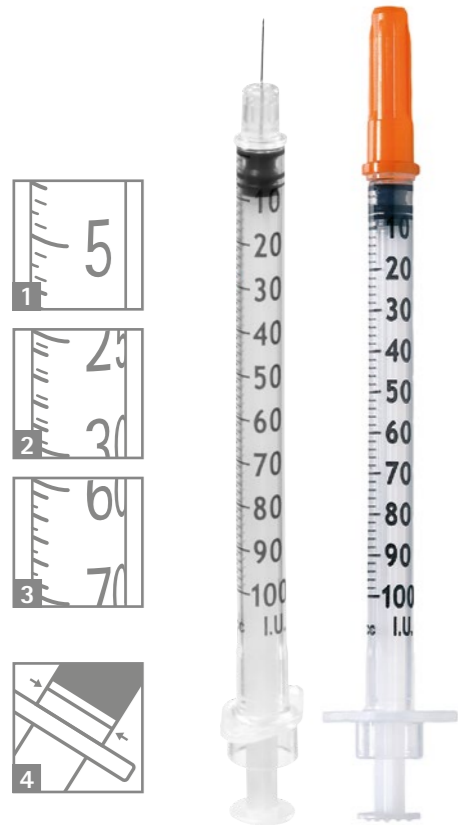

Product Features

- Fine 0.5 I.U. graduation (Omnican® 20) (1), 1 I.U. graduation (Omnican® 40 and 50) (2) or 2 I.U. graduation (Omnican® 100) (3)
- U-40 insulin = red protection cap
- U-100 insulin = orange protection cap
- Highly transparent barrel
- High contrast black graduation
- Integrated plunger backstop (4)
- Barrel made of polypropylene
- Plunger made of polystyrene
- Plunger stopper with double sealing ring made of polyisoprene
- Protective cap made of polyethylene
- Integrated thin-wall needle (according to EN ISO 9626) with fine three-facets grinding and special silicone finish
- Not manufactured with Latex, PVC, DEHP and BPA
- Sterile single packaging
- Box of 100 pcs.

User Benefits

- Highly transparent barrel with high-contrast black graduation for easy reading and exact dosing
- Lowest dead space syringe within the B. Braun syringe portfolio: reduced insulin loss due to integrated fine needle
- Barely perceptible puncture of skin due to precise three-facet bevel and silicone finish
- Highly transparent barrel to make sure that air bubbles are easily identified
- Safe plunger backstop helps to prevent unintentional plunger withdrawal and the loss of any liquids

I.U. = International Unit

Note: More detailed information on Low Dead Space syringes can be found on page 27.

Omnican® 20 and Omnican® 40 for U-40 insulin with integrated needle, manufactured according to ISO 8537

U-40

Maximum volume in I.U.	Graduation / Scale Value	Gauge x Length (inch)	Ø x Length	Units Per Box	Code No. (REF)
20 I.U. for insulin U-40	insulin U-40 with scale value 0.5 I.U.	30 G x 5/16 "	0.3 x 8 mm		9161619S
40 I.U. for insulin U-40	insulin U-40 with scale value 1 I.U.	30 G x 5/16 "	0.3 x 8 mm	100 pcs.	9161635S
40 I.U. for insulin U-40	insulin U-40 with scale value 1 I.U.	30 G x 1/2 "	0.3 x 12 mm		9161627S

Omnican® 50 and Omnican® 100 for U-100 insulin with integrated needle, manufactured according to ISO 8537

U-100

Maximum volume in I.U.	Graduation / Scale Value	Gauge x Length (inch)	Ø x Length	Units Per Box	Code No. (REF)
50 I.U. for insulin U-100	insulin U-100 with scale value 1 I.U.	30 G x 5/16 "	0.3 x 8 mm		9151117S
50 I.U. for insulin U-100	insulin U-100 with scale value 1 I.U.	30 G x 1/2 "	0.3 x 12 mm	100 pcs.	9151125S
100 I.U. for insulin U-100	insulin U-100 with scale value 2 I.U.	30 G x 5/16 "	0.3 x 8 mm		9151133S
100 I.U. for insulin U-100	insulin U-100 with scale value 2 I.U.	30 G x 1/2 "	0.3 x 12 mm		9151141S

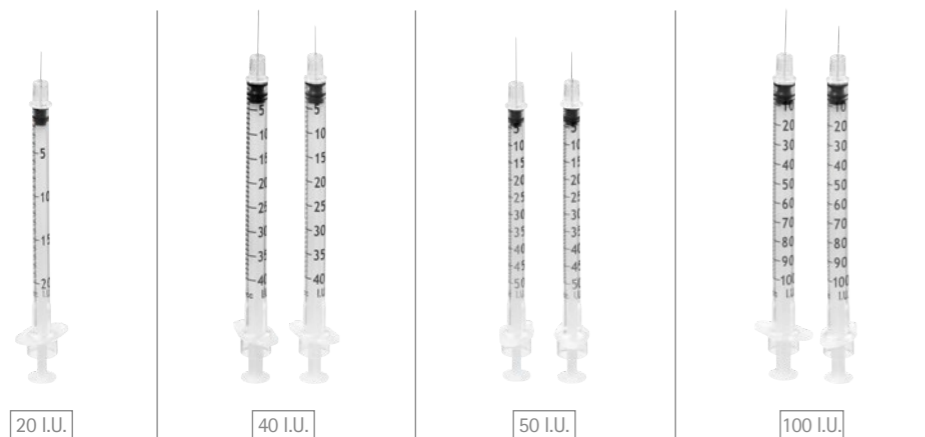

Pen Needles

Pen needles for insulin injection



Stay on the safe side

Pen needles are sterile single-use products. Multiple use reduces quality and safety. Change the pen needle after every injection! Discard used pen needles into a sharps bin.



Omnican® fine

Pen needles for insulin injection

Product Features

- Fine three-facet grinding
- Ultra-thin wall, extra-thin wall and thin wall technology
- Cannula made of stainless steel with a silicone finish
- Needle container made of polyethylene
- Needle hub made of polypropylene
- Glue made of UV-curable adhesive
- Needle shield made of styrene-butadiene copolymer
- Not manufactured with PVC, Latex, DEHP and BPA
- In conformity with REACH regulation (EC) No 1907/2006
- Sterile pen needles
- Box of 100 pcs.

User Benefits

- Fine three-facet grinding reduces tissue trauma
- Special silicone finish for smooth gliding and virtually pain-free penetration of skin and tissue
- The ultra- and extra-thin wall technology allow for a larger inner diameter and an optimized insulin flow; less force is required, and injection time is reduced
- Firm and secure fit with just two twists of the hub
- Compatible with all major pen devices available on the market



Omnican® fine, manufactured according to ISO 11608-2

Gauge x Length (inch)	Ø x Length	Technology	Units Per Box	Code No. (REF)
32 G x 5/32 "	0.23 x 4 mm	Ultra-thin wall	100 pcs.	932G04S-41
32 G x 1/4 "	0.23 x 6 mm	Ultra-thin wall		932G06S-41
31 G x 5/32 "	0.25 x 4 mm	Extra-thin wall		931G04S-41
31 G x 1/4 "	0.25 x 6 mm	Extra-thin wall		931G06S-41
31 G x 5/16 "	0.25 x 8 mm	Extra-thin wall		931G08S-41
29 G x 1/2 "	0.33 x 12 mm	Thin wall		929G12S-41

Omnican® fine pen needles fit a high variety of insulin injectors, in accordance with ISO 11608-2.

Further information:

<https://www.bbraun.com/en/products/b/omnican-fine.html#>



Omnican® fine Comfort

Pen needles with integrated sharps disposal container



Stay on the safe side

Pen needles are sterile single-use products. Multiple use reduces quality and safety. Change the pen needle after every injection! Discard used pen needles into a sharps bin.



Omnican® fine Comfort

Pen needles with integrated sharps disposal container

PRODUCT FEATURES

- Product includes 100 pen needles and a medical sharps container
- Sterile pen needles
- Fine three-facet grinding
- Extra-thin-wall technology
- Cannula made of stainless steel with a silicone finish
- Needle hub made of polypropylene
- Glue made of UV-curable adhesive
- Needle shield made of styrene-butadiene copolymer
- Not manufactured with PVC, Latex, DEHP and BPA
- In conformity with REACH regulation (EC) No 1907/2006
- Needle container made of polyethylene
- Sharps container according to EN ISO 23017:2012

User Benefits

- Simple detachment of the pen needle with the help of the Omnican® fine box
- Effective prevention of needlestick injuries as there is no need to touch the needle again
- Safe disposal in the sharps container due to its final locking system
- Handy – at home or on the move
- Further advantages of Omnican® fine pen needles on page 61



Omnican® fine Comfort, manufactured according to ISO 11608-2

Gauge x Length (inch)	Ø x Length	Technology	Units Per Box	Code No. (REF)
31 G x 5/32 "	0.25 x 4 mm	Extra-thin wall	100 pcs. + 1 sharps container	9167846SE
31 G x 1/4 "	0.25 x 6 mm	Extra-thin wall		9167668SE
31 G x 5/16 "	0.25 x 8 mm	Extra-thin wall		9167684SE
29 G x 1/2 "	0.33 x 12 mm	Thin wall		9167641SE

Omnican® fine pen needles fit a high variety of insulin injectors, in accordance with ISO 11608-2.

Further information:

<https://www.bbraun.com/en/products/b0/omnican-fine-comfort.html#>

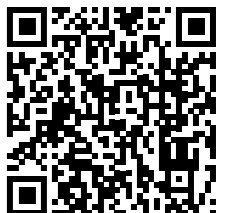

Needle Terminology

Components

Needle point

The needle point refers to the sharpened angular tip at the end of the needle.

Needle gauge size

Needle gauge size indicates the thickness or outer diameter of the needle and can also be indicated by a corresponding metric size (ISO 6009). The higher the gauge size, the thinner the needle.

Needle length

The needle length is the usable length for injection and measures from the end of the hub to the needle point.

Lubricant

The needle tube is coated evenly with silicone oil to ensure a smooth surface.

Needle hub

The needle hub has a female Luer Lock connector enabling compatibility with male Luer and Luer Lock connectors. The color-coded plastic hub allows for easy identification of the outer needle diameter in accordance with ISO 6009.



Bevel

The bevel refers to the cut at the end of the needle required to penetrate the skin of the patient. The 3-facet bevel is divided into the primary and secondary bevel that can have different lengths and angles depending on the bevel type.

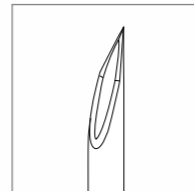

Long bevel

The long bevel has a longer primary bevel at a smaller angle and is the most common bevel type.

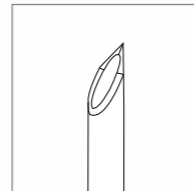

Short bevel

The short bevel has a shorter primary bevel at a higher angle that helps to prevent undesired injection depth.



Needle cap

A translucent needle cap covers and protects the needle tube.

Injection Routes

Techniques and application

Intramuscular	Subcutaneous	Intravenous	Intradermal
90°	45°	25°	10°-15°
Definition			
Administration within a muscle	Administration beneath the skin	Administration within or into a vein	Administration within the dermis
Injection angle			
90°	45° or 90° (skin fold may be required)	25°	10° - 15°
Common Injection Site			
Deltoid muscle of arm, vastus lateralis muscle of thigh	Anterolateral thigh, upper outer tricep area, upper buttocks, or abdomen	Back of the hands, front and back of the lower arm, or front elbow pit	Anterior aspect of forearm, upper chest, upper back, or back of upper arm
Application			
Larger volume injections e.g. vaccinations	Small volume injections (≤ 1ml) for e.g. insulin, heparin injection	Rapid administration and controlled medication dosing e.g. anesthesia, blood sampling	Very small volumes (≤ 0.5ml) and diagnostic purposes for tests

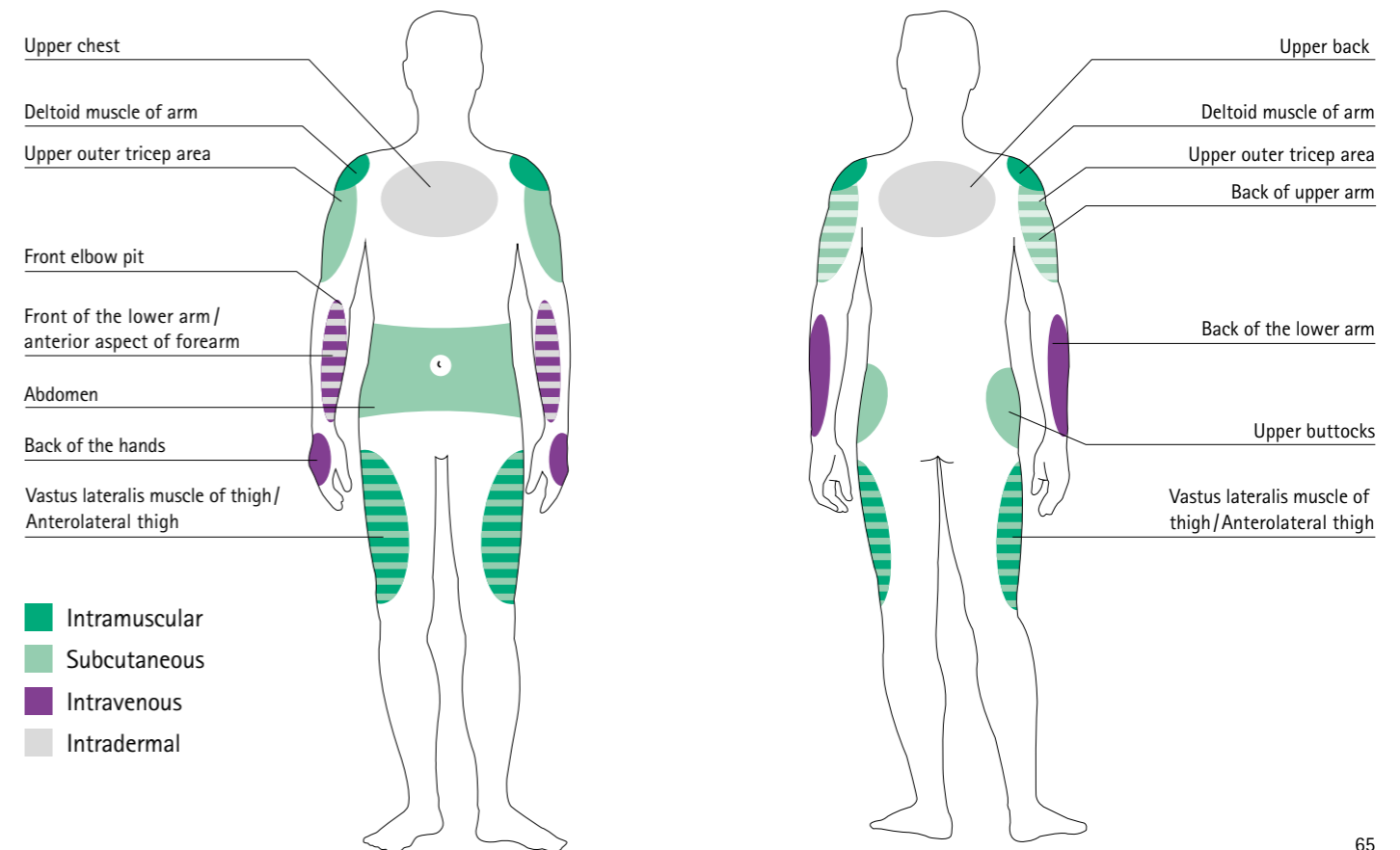

Hypodermic Standard, Blunt and Safety Needles

Sterican[®], Sterican[®] Blunt and Sterican[®] Safety Needle

For injection, B. Braun offers an extensive range of single-use short bevel and long bevel needles for standard applications. The range also includes blunt needles as well as safety needles.



Hypodermic standard needles with Luer Lock connector and bevel length according to indication

Product Features

- Made of stainless chromium nickel steel
- Translucent Luer Lock plastic hub made of polypropylene
- Silicone coating
- Three-facet bevel
- Color-coded hub in accordance with ISO 6009
- Not manufactured with PVC, Latex, DEHP and BPA
- Sterile single packaging
- Box of 100 pcs.

User Benefits

- Smooth surface due to finely dosed silicone coating
- Bevel length according to indication
- Color-coded hub for easier identification of the outer needle diameter
- Compatible with all standard Luer and Luer Lock syringes
- Available in needle gauge sizes ranging from 30 G - 18 G: wide portfolio allows injections and blood samplings on different patients and at various injection sites

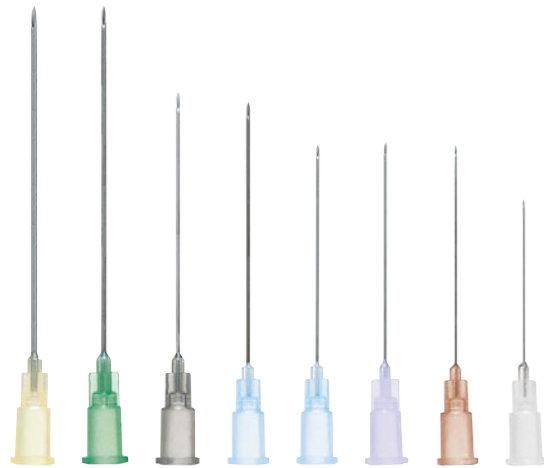

Sterican®, manufactured according to ISO 7864

Gauge x Length (inch)	Ø x Length	Bevel Type	Units Per Box	Code No. (REF)
30 G x 1/2 "	0.30 x 12 mm	Long bevel	100 pcs.	4656300
27 G x 1/2 "	0.40 x 12 mm	Long bevel	100 pcs.	4665406
27 G x 3/4 "	0.40 x 20 mm	Long bevel	100 pcs.	4657705
27 G x 1 "	0.40 x 25 mm	Long bevel	100 pcs.	9186174
27 G x 1 1/2 "	0.40 x 40 mm	Long bevel	100 pcs.	9186182
26 G x 1/2 "	0.45 x 12 mm	Long bevel	100 pcs.	4665457
26 G x 1 "	0.45 x 25 mm	Long bevel	100 pcs.	4657683
25 G x 5/8 "	0.50 x 16 mm	Long bevel	100 pcs.	4657853
25 G x 1 "	0.50 x 25 mm	Long bevel	100 pcs.	9186158
25 G x 1 1/2 "	0.50 x 40 mm	Long bevel	100 pcs.	9186166
24 G x 1 "	0.55 x 25 mm	Long bevel	100 pcs.	4657675
23 G x 1 "	0.60 x 25 mm	Long bevel	100 pcs.	4657667
23 G x 1 1/4 "	0.60 x 30 mm	Long bevel	100 pcs.	4657640
23 G x 2 3/8 "	0.60 x 60 mm	Long bevel	100 pcs.	4665600
23 G x 3 1/8 "	0.60 x 80 mm	Long bevel	100 pcs.	4665635
22 G x 1 1/4 "	0.70 x 30 mm	Long bevel	100 pcs.	4657624
22 G x 1 1/2 "	0.70 x 40 mm	Long bevel	100 pcs.	4660021
22 G x 2 "	0.70 x 50 mm	Long bevel	100 pcs.	4650018
21 G x 1 "	0.80 x 25 mm	Long bevel	100 pcs.	4657543
21 G x 1 1/2 "	0.80 x 40 mm	Long bevel	100 pcs.	4657527
21 G x 2 "	0.80 x 50 mm	Long bevel	100 pcs.	4665503
21 G x 3 1/8 "	0.80 x 80 mm	Long bevel	100 pcs.	4665465
21 G x 4 3/4 "	0.80 x 120 mm	Long bevel	100 pcs.	4665643
20 G x 1 "	0.90 x 25 mm	Long bevel	100 pcs.	4657500
20 G x 1 1/2 "	0.90 x 40 mm	Long bevel	100 pcs.	4657519
20 G x 2 "	0.90 x 50 mm	Short bevel	100 pcs.	4667093
20 G x 2 3/4 "	0.90 x 70 mm	Long bevel	100 pcs.	4665791
19 G x 1 1/4 "	1.10 x 30 mm	Long bevel	100 pcs.	4665317
19 G x 1 1/2 "	1.10 x 40 mm	Long bevel	100 pcs.	4657799
19 G x 1 1/2 "	1.10 x 40 mm	Short bevel	100 pcs.	4665112
19 G x 2 "	1.10 x 50 mm	Long bevel	100 pcs.	4665511
18 G x 1 1/2 "	1.20 x 40 mm	Short bevel	100 pcs.	4665120
18 G x 1 1/2 "	1.20 x 40 mm	Long bevel	100 pcs.	4650034
18 G x 2 "	1.20 x 50 mm	Short bevel	100 pcs.	4667123

Handling instructions



Carefully remove Sterican® from the packaging.



Attach the needle securely to any Luer or Luer Lock syringe by twisting the syringe clockwise while holding the needle close to its base.



Remove the needle cap carefully straight from the needle hub to avoid exposure to the sharp needle point.



Perform injection according to your established procedure.



Take care during disposal as sharp needle bevel is not protected.



Dispose the used needle immediately after application into an approved sharps container following the standard procedures of your facility and/or according to applicable regulations for sharps disposal.



In order to view the Sterican® handling poster directly on your mobile phone and to obtain product information, simply scan the QR code with the camera of your smartphone and a suitable reader application and get to the website.

Blunt needle



Product Features

- Blunt needle in 21 G and 27 G
- Made of stainless chromium nickel steel
- Transparent Luer Lock plastic hub made of polypropylene
- Silicone coating
- Blunt bevel (90°)
- Color-coded hub in accordance with ISO 6009
- Not manufactured with PVC, Latex, DEHP and BPA
- Sterile single packaging
- Box of 100 pcs.

User Benefits

- Blunt bevel design reduces the risk of needlestick injuries
- Smooth surface due to finely dosed silicone coating
- Color-coded hub for easier identification of the outer needle diameter
- Compatible with all standard Luer and Luer Lock syringes

Sterican® Blunt, manufactured according to ISO 7864

Gauge x Length (inch)	Ø x Length	Bevel Type	Bevel Angle	Units Per Box	Code No. (REF)
27 G x 1"	0,40 x 25 mm	Blunt	90°	100 pcs.	9180117
21 G x 7/8"	0,80 x 22 mm				9180109

Sterican® Safety Needle

Hypodermic safety needles with Luer Lock connector and bevel length according to indication



Product Features

- Made of stainless chromium nickel steel
- Translucent Luer Lock plastic hub made of polypropylene
- Silicone coating
- Three-facet long bevel
- Color-coded hub in accordance with ISO 6009
- Compliant with EU Directive (2010/32/EU)
- Not manufactured with PVC, Latex, DEHP and BPA
- Sterile single packaging
- Box of 100 pcs.

User Benefits

- Anti-needlestick device to reduce the risk of accidental needlesticks
- Visual and audible feedback is provided during activation of safety mechanism to confirm that the needle is secured
- Up to three hooks help to ensure a secure locking of the needle
- One-piece design ensures that safety shield and needle remain securely engaged during the application process
- Smooth needle surface due to finely dosed silicone coating
- Color-coded hub for easier identification of the outer needle diameter
- Compatible with all standard Luer and Luer Lock syringes

Sterican® Safety Needle, manufactured according to ISO 7864

Gauge x Length (inch)	Ø x Length	Bevel Type	Units Per Box	Code No. (REF)
30 G x 1/2 "	0.30 x 13 mm	Long bevel	100 pcs.	4670002S-01
27 G x 1/2 "	0.40 x 13 mm		100 pcs.	4670005S-01
26 G x 1/2 "	0.45 x 13 mm		100 pcs.	4670008S-01
25 G x 5/8 "	0.50 x 16 mm		100 pcs.	4670012S-01
25 G x 1 "	0.50 x 25 mm		100 pcs.	4670016S-01
25 G x 1 1/2 "	0.50 x 40 mm		100 pcs.	4670020S-01
24 G x 1 "	0.55 x 25 mm		100 pcs.	4670022S-01
23 G x 1 "	0.60 x 25 mm		100 pcs.	4670025S-01
23 G x 1 1/4 "	0.60 x 30 mm		100 pcs.	4670027S-01
23 G x 1 1/2 "	0.60 x 40 mm		100 pcs.	4670028S-01
22 G x 1 "	0.70 x 25 mm		100 pcs.	4670030S-01
22 G x 1 1/4 "	0.70 x 30 mm		100 pcs.	4670032S-01
22 G x 1 1/2 "	0.70 x 40 mm		100 pcs.	4670035S-01
21 G x 1 "	0.80 x 25 mm		100 pcs.	4670040S-01
21 G x 1 1/4 "	0.80 x 30 mm		100 pcs.	4670042S-01
21 G x 1 1/2 "	0.80 x 40 mm		100 pcs.	4670045S-01
20 G x 1 "	0.90 x 25 mm		100 pcs.	4670047S-01
20 G x 1 1/2 "	0.90 x 40 mm		100 pcs.	4670050S-01
19 G x 1 1/2 "	1.10 x 40 mm		100 pcs.	4670052S-01
18 G x 1 "	1.20 x 25 mm		100 pcs.	4670053S-01
18 G x 1 1/2 "	1.20 x 40 mm		100 pcs.	4670055S-01



Sterican® Safety Needle

Product details



Secure Locking

- Up to three hooks help to ensure a secure locking of the needle
- Visual and audible feedback is provided during activation of safety mechanism to confirm that needle is secured



Bevel Orientation

- Bevel-up orientation of needle indicated by opposite position of safety shield



Safety Mechanism

- Safety shield to cover needle after application: Supports the protection from NSI by covering the needle after application



Easy Activation

- Activation of safety shield with one-hand technique: Helps to ensure that the hand of the user is behind the needle
- Grip plate for easy activation: Allows for standard puncture technique without extra steps

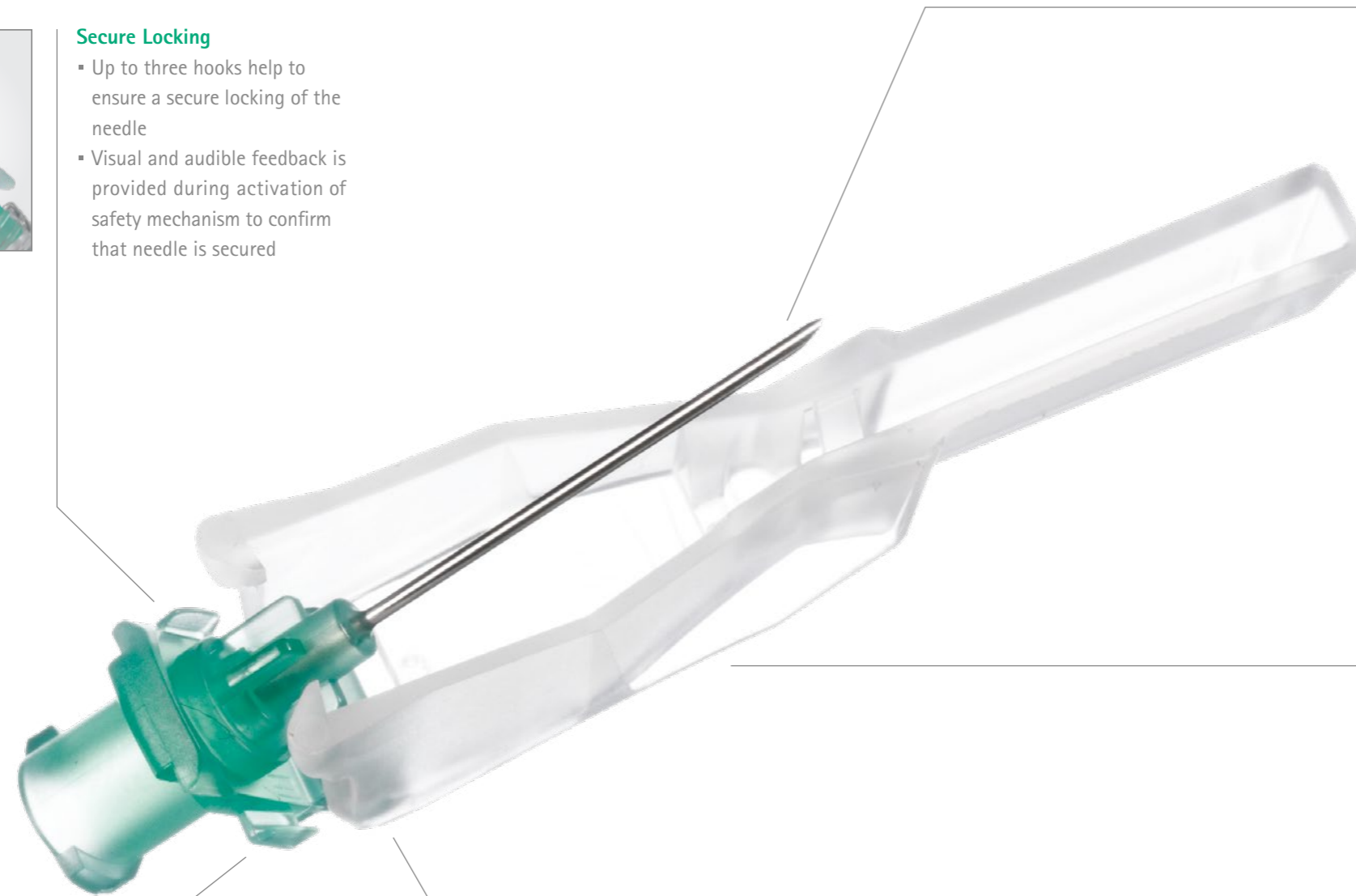

One-Piece Design

- One-piece design ensures that safety shield and needle remain securely engaged during the application process



Adjustable Hinge

- Hinge allows for easy adjustment of safety shield according to application

Technical Features

- Available in sizes G30-G18
- Compatible with all standard Luer and Luer Lock syringes
- Made of stainless chromium-nickel steel
- Made of polypropylene (needle hub)
- In compliance with EU Directive 2010/32/EU
- Color-coding according to ISO 6009

Sterican® Safety Needle

Handling instructions



Carefully remove Sterican® Safety Needle from the packaging.



Attach the safety needle securely to any Luer or Luer Lock syringe by twisting the syringe clockwise while holding the clear needle safety shield close to its base.



Hold the syringe with one hand and with the other hand fold the safety shield back towards the syringe.



If activating with one hand, position your thumb or forefinger carefully on the textured finger plate. Push the safety shield over the needle until a slight snap is felt and an audible click is heard. Perform activation of the safety feature away from yourself and others.



Be sure to visually confirm that the safety feature is engaged before disposal.



After activation dispose the used needle immediately into an approved sharps container following the standard procedures of your facility and/or according to applicable regulations for sharps disposal.



Remove the needle cap carefully from the needle hub to avoid exposure to the sharp needle point.



Perform injection according to your established procedure.

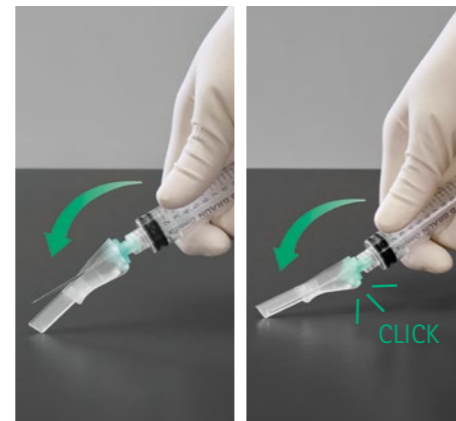

Activate the mechanism by pressing the safety shield against a suitable hard and flat surface until you hear an audible click.



In order to view the Sterican® Safety Needle handling video directly on your mobile phone and to obtain product information, simply scan the QR code with the camera of your smartphone and a suitable reader application and get to the website.

Admixture Needles

Sterican® MIX, Sterifix® and aspiration needle

For drug admixture, B. Braun offers blunt and semi-blunt needles with and without filter for drawing up medications as well as the aspiration needle used for fluid transfer. In addition, the range includes the Sterifix® Filter Needle for withdrawal or injection of medication and fluids available with Luer Lock and NRFit® Lock connector.



Semi-Blunt and Blunt Needles for Admixture

Types and application



Stay on the safe side

The use of admixture needles guarantees the 2-needle technique and ensures that a new sterile needle is used for patient injection.

Comparing two different types of Sterican® MIX



Semi-blunt

Type: Semi-blunt

Bevel: 40° / 45°

Application: Intended to puncture vials with a rubber stopper. It can be used as well with open containers.



Blunt

Type: Blunt

Bevel: 90°

Application: Should be used with glass ampoules or other open containers only.

User Benefits

- Compliance with safety guidelines
- Guaranteed 2-needle technique
- Reduced risk of needlestick injuries and related infections (e.g. Hepatitis A, B and HIV)
- Reduced risk of chemical contamination

Semi-Blunt and Blunt Needles for Admixture

Use of 2-needle technique

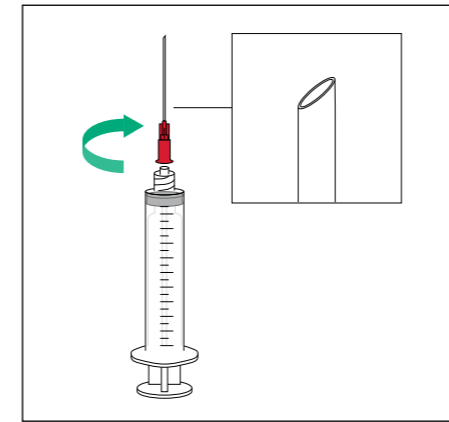

1. Connect semi-blunt Sterican® MIX needle to Luer or Luer Lock syringe and remove needle cap.

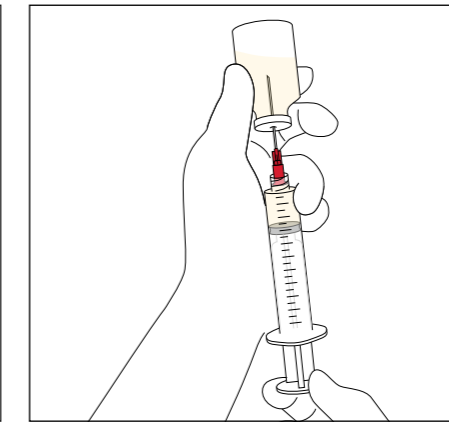

2. Draw up medication from vial.

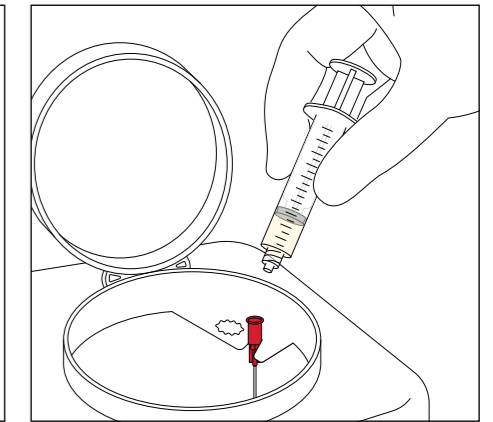

3. Dispose semi-blunt needle into sharps container.

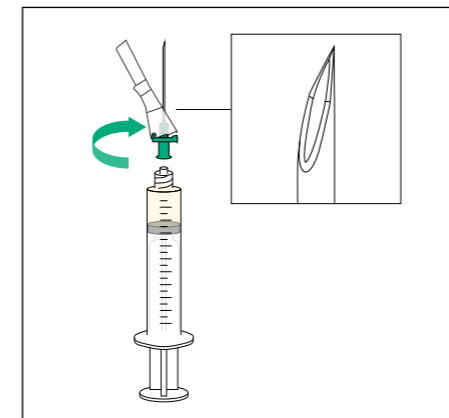

4. Connect Sterican® Safety Needle to the prepared syringe (2-needle technique) and remove needle cap.

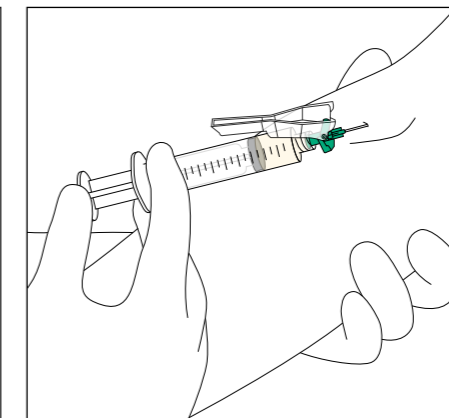

5. Inject medication into patient with Sterican® Safety Needle.

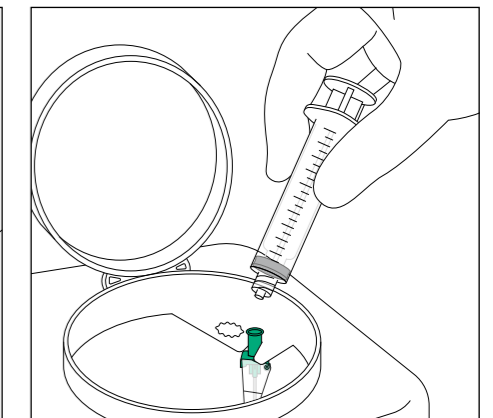

6. After activation of the safety mechanism dispose Sterican® Safety Needle into sharps container.

For a detailed description of product specific handling please refer to the respective handling instructions.



In order to view the Sterican® MIX handling poster directly on your mobile phone and to obtain product information, simply scan the QR code with the camera of your smartphone and a suitable reader application and get to the website.

Sterican® MIX Semi-Blunt Needle

Semi-blunt needles with Luer Lock connector for drug admixture (with and without filter)

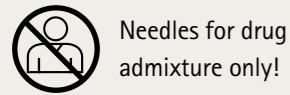

Needles for drug admixture only!

Product Features

- Needle with and without 5 micron filter
- Made of stainless chromium nickel steel
- Semi-blunt bevel (40° and 45°)
- Red and purple colored needle hub made of polypropylene
- Smooth surface and finely dosed silicone coating
- Compatible with Luer and Luer Lock connectors
- Not manufactured with PVC, Latex, DEHP and BPA
- Sterile single packaging
- Box of 100 pcs.

User Benefits

- 40° and 45° bevel angle for draw up of medications e.g. from glass and plastic ampoules
- Blunt needle with filter features a 5 micron filter membrane that is designed to prevent larger particles being drawn into the syringe when preparing medication from glass ampoules
- Guaranteed 2-needle technique ensuring that a new sterile needle is used for patient injection
- Clear differentiation from ISO colored injection needles due to red and purple color coding
- Compatible with all standard Luer and Luer Lock syringes



Sterican® MIX Blunt Needle

Blunt needles with Luer Lock connector for drug admixture

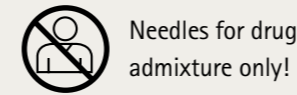

Needles for drug admixture only!

Product Features

- Made of stainless chromium nickel steel
- Blunt bevel (90°)
- Colored needle hub made of polypropylene
- Smooth surface and finely dosed silicone coating
- Compatible with Luer and Luer Lock connectors
- Not manufactured with PVC, Latex, DEHP and BPA
- Sterile single packaging
- Box of 100 pcs.

User Benefits

- Blunt bevel design reduces the risk of needlestick injuries
- 90° bevel angle draw up of medications e.g. from glass and plastic ampoules
- Guaranteed 2-needle technique ensuring that a new sterile needle is used for patient injection
- Compatible with all standard Luer and Luer Lock syringes

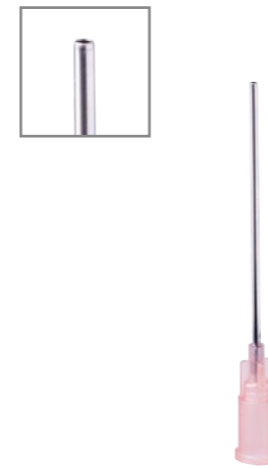

Sterican® MIX and SOL-M™ Blunt Fill Needle, manufactured according to ISO 7864

Product	Gauge x Length (inch)	Ø x Length	Bevel Type	Bevel Angle	Units Per Box	Code No. (REF)
Sterican® MIX	18 G x 1 1/2 "	1.2 x 40 mm		40°		4550400-01
SOL-M™ Blunt Fill Needle	18 G x 1 1/2 "	1.2 x 40 mm		45°		110022
SOL-M™ Blunt Fill Needle	18 G x 2 "	1.2 x 50 mm	Semi-blunt	45°	100 pcs.	110023
SOL-M™ Blunt Fill Needle W/5 Micron Filter *	18 G x 1 1/2 "	1.2 x 40 mm		45°		110022F
SOL-M™ Blunt Fill Needle W/5 Micron Filter *	18 G x 2 "	1.2 x 50 mm		45°		110023F

* The SOL-M™ Blunt Fill Needle W/5 Micron Filter can either be used for aspiration or injection of liquids. The needle should not be used for both as this would free the particle in the solution. It can be used in one direction once.

Sterican® MIX, manufactured according to ISO 7864

Product	Gauge x Length (inch)	Ø x Length	Bevel Type	Bevel Angle	Units Per Box	Code No. (REF)
Sterican® MIX	18 G x 1 1/2 "	1.2 x 40 mm	Blunt	90°	100 pcs.	4038088-01

Sterifix® Filter Needle

Needle with integrated filter for withdrawal or injection of medication



Needles for drug admixture only!

Product Features

- Thinwall needle made of stainless chromium nickel steel
- Integrated 5 µm filter
- Not manufactured with PVC, Latex and DEHP
- Sterile single packaging
- Box of 50 pcs.

User Benefits

- Withdrawal and filtration of medication from rubber stoppered vials
- 5 µm filter reduces the risk of particle contamination
- Compatible with all standard Luer and Luer Lock syringes



Sterifix® Filter Needle

Gauge x Length (inch)	Ø x Length	Bevel Type	Units Per Box	Code No. (REF)
19 G x 1 "	1,1 x 25 mm	Short bevel	50 pcs.	4550404

*The Sterifix® Filter Needle can either be used for aspiration or injection of liquids. The needle should not be used for both as this would free the particle in the solution. It can be used in one direction once.

Sterifix® Filter Needle NRFit®

Needle with integrated filter for withdrawal or injection of medication for regional anesthesia



Needles for drug admixture only!

Product Features

- Thinwall needle made of stainless chromium nickel steel
- Integrated 5 µm filter
- NRFit® Lock connector
- Not manufactured with PVC, Latex and DEHP
- Sterile single packaging
- Box of 50 pcs.

User Benefits

- Withdrawal and filtration of medication for regional anesthesia
- Helps to prevent medication errors and particle contamination in regional anesthesia
- NRFit® Lock connector



Sterifix® Filter Needle NRFit®

Gauge x Length (inch)	Ø x Length	Bevel Type	Units Per Box	Code No. (REF)
19 G x 1 "	1,1 x 25 mm	Short bevel	50 pcs.	4550404N

*The Sterifix® Filter Needle NRFit® can either be used for aspiration or injection of liquids. The needle should not be used for both as this would free the particle in the solution. It can be used in one direction once.

Aspiration needle

Aspiration needle with and without filter (Type Luer Lock) for fluid transfer

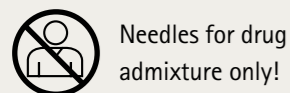

Needles for drug admixture only!



Product Features

- Made of stainless chromium nickel steel
- Transparent Luer Lock plastic hub made of polypropylene
- Compatible with Luer and Luer Lock connectors
- Not manufactured with PVC, Latex and DEHP
- Sterile single packaging
- Box of 100 pcs.

User Benefits

- Large steel cannula tube with sharp bevel is used for the preparation of drugs for various applications
- The usage without rotation of the cannula allows penetration of the vial with minimal coring
- The filter, used for aspiration needles with filter, ensures that particles exceeding 15 µm size cannot be drawn up or injected
- Compatible with all standard Luer and Luer Lock syringes

Abbreviations

- PVC: Polyvinylchloride
- BPA: Bisphenol A
- DEHP: Diethylhexylphthalate
- ISO: International Organization for Standardization
- PHT: Polyhexahydrotriazine
- UV: Ultraviolet
- NSI: Needlestick injuries

Features for product and packaging are characterized in accordance with Part 3 of Annex VI to Regulation (EC) No 1272/2008 of the European Parliament and of the Council.

Aspiration needle, manufactured according to ISO 22413

Product	Gauge x Length	Ø x Length	Units Per Box	Code No. (REF)
Aspiration needle without filter	14 G x 1 ¼ "	2.0 x 30 mm	100 pcs.	8258813
Aspiration needle with 15 µm particle filter*	14 G x 1 ⅝ "	2.0 x 28 mm		8258821

*The aspiration needle with filter can either be used for aspiration or injection of liquids. The needle should not be used for both as this would free the particle in the solution. It can be used in one direction once.



Medibox®

Sharps disposal containers

Product Features

- Medibox sharps disposal containers are complying with international standard ISO 23907, ADR2015 and 2008/68/EC
- Impact and puncture resistant according to ISO 23907
- Container and lid made of polypropylene



User Benefits

- No-touch, twist-off and insertion inlets for all kinds of used Luer and Luer Lock needles as well as pen needles
- Large opening to ease the insertion of various medical sharps
- Easy to use temporary closure
- Irreversible final lock mechanism
- Overfill warning by maximum fill line

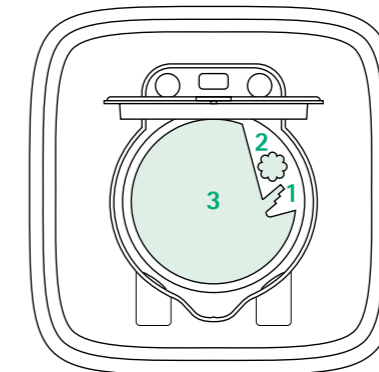

Medibox® 0.8 L - 9.1 L

Disposal of

- Luer and Luer Lock needles
- Pen needles
- Various medical sharps

Medibox® 4,7 L Fill line on the lid
max. 3,9 L ↑
 REF 9193618
 PZN 13847376
 3H2/Y2,25/S/18
 I/CPABO 0002-J/KETER ITALIA SPA
 UN3291
 DANGER ISO 23907: 2012 KM 99113
 www.bbraun.com
 B. Braun Melsungen AG
 Carl-Braun-Str. 1, 34212 Melsungen, Germany **B | BRAUN**

Size	Max. Filling Volume	Dimension (L x W x H)	Base (L x W)	Units Per Box	Code No. (REF)
0.8 L	0.67 L	18 x 9.8 x 9.8 cm	Ø 7.5 cm	18 pcs.	9193424
2.4 L	2.0 L	15.1 x 15.2 x 20 cm	11 x 11 cm	27 pcs.	9193600
4.7 L	3.9 L	19 x 19 x 20.5 cm	15 x 15 cm	25 pcs.	9193618
5.7 L	4.8 L	19 x 19 x 25.7 cm	13.9 x 13.9 cm	25 pcs.	9193627
6.8 L	5.7 L	16.7 x 16.7 x 50 cm	Ø 11 cm	22 pcs.	9193639
9.1 L	7.7 L	21.5 x 21.5 x 32.5 cm	17 x 17 cm	13 pcs.	9193640

Accessories	Units Per Box	Code No. (REF)
Medibox® 6.8 L Holding bracket for pole mounting	1 pc (16 pcs./carton)	9193639-0
Medibox® 9.1 L Fixation screw for pole mounting	1 pc (100 pcs./carton)	9193640-0

Handling instructions

1 Lid assembly



Place the lid on the medical waste container and press firmly on the opposite corners of the lid until a "click" confirms the lock.

Check that the lid is properly locked on all sides!

2 disposal



Open the lid by applying slight pressure on the tab – the lid flap jumps up slightly.

Push the lid flap with one hand, until it locks into a standing position.

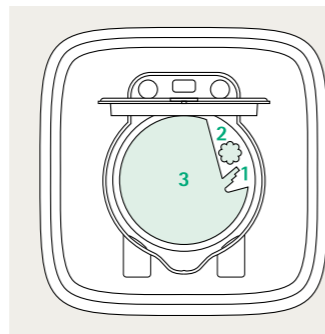

Disposal of

- 1 Luer and Luer Lock needles
- 2 Pen needles
- 3 Various medical sharps



1a Disconnect Luer and Luer Lock connections between syringe and cannula.



2 Unscrew a pen needle from a pen.



3 Dispose large medical sharps.

3 Lid closure



Temporary closure:

Release the lid flap from the standing position and press it lightly onto the housing.

Permanent closure:

Close the Medibox® after reaching the maximum filling volume (see marking line on lid) by simultaneously pressing on the marked pressure points.

Dispose the permanently closed Medibox® in accordance with your local regulations.



In order to view the Medibox® handling video directly on your mobile phone and to obtain product information, simply scan the QR code with the camera of your smartphone and a suitable reader application and get to the website.

