



TRI W-G®

215 - 12th Avenue NE
Valley City, ND 58072-0905

1-800-437-8011
triwg@triwg.com
www.triwg.com

FOR CUSTOMER ASSISTANCE

As a future reference, we suggest you record the information listed below for quick accessibility.

Model No.: _____

Serial No.: _____

Purchase Date: _____

Purchased From: _____

Tri W-G® Service:

1-800-437-8011

triwg@triwg.com



USER MANUAL

P/N: 920-002-030

For

Hi-Lo Mat Table TG.1500 series



Read this manual before installing, operating, or maintaining this table. Failure to follow safety precautions and instructions could cause a system failure and result in serious injury, death or property damage.

LIMITED WARRANTY REGISTRATION CARD ENCLOSED

TABLE OF CONTENTS



INTRODUCTION2

1.0 RECEIVING INSPECTION2

2.0 UNCRATING2

3.0 INSTALLATION2

4.0 SAFETY/PRECAUTIONARY INSTRUCTIONS3

5.0 INTENDED USE10

6.0 INTENDED USER PROFILE10

7.0 INTENDED CONDITIONS of USE10

8.0 OPERATING INSTRUCTIONS10

9.0 MAINTENANCE11

10.0 SYMBOLS, INDICATORS, and DEGREE OF SAFETY11

11.0 WARNINGS and USAGE HINTS12

12.0 OTHER HAZARDS13

13.0 SPECIFICATIONS15

14.0 STARTUP CONDITIONS16

15.0 OPERATING CONDITIONS16

16.0 STORAGE CONDITIONS16

17.0 TRANSPORT CONDITIONS16

18.0 NOTICE/SERVICE16

19.0 TROUBLESHOOTING17

20.0 REPLACEMENT PARTS18

21.0 SYSTEM SCHEMATIC20

22.0 DISPOSAL21

WARRANTY21

DISCLAIMER22

INTRODUCTION

The purpose of the User Manual is to introduce the authorized user to the operating instructions on how to use and work with this medical device safely, and to conduct routine preventative maintenance procedures on the device. For this goal to be achieved, it is essential that all the authorized users/operators (“user”) read this manual carefully, and understand and practice the precautionary safety measures recommended in it. The owner and/or operating authority determines who the user is. **This User Manual can only be of any use if the operator and/or user has access to it at all times. Therefore, always keep a copy of it accessible to the operator and/or user near this device**

ANYONE OPERATING THIS DEVICE MUST READ THIS USER MANUAL.

1.0 RECEIVING INSPECTION

1.1 Inspect for visible damage of the container. If there is outside damage, note on the shipping documents, and report to commercial carrier. Determine whether or not to accept or refuse the container. Sign if appropriate.

2.0 UNCRATING

2.1 Upon acceptance of the container, inspect for any damage to the device immediately following uncrating. In the event the device is damaged, **DO NOT** use the mat table if damaged, file a merchandise damage report immediately with the delivering carrier. **DO NOT** return damaged merchandise to Tri W-G® unless instructed to do so. Call for a Return Authorization Number prior to returning any merchandise.

2.2 Keep the cardboard liner on top of the table while moving mat table to the desired location. This will prevent damage to the frame and/or cushion while moving the table down hallways, through doorways, etc.

2.3 Remove all other packaging material from the table, except for the cardboard cushion liner/protector.

2.4 Properly dispose of/or recycle all packaging material.

3.0 INSTALLATION

3.1 **WARNING! Excessive Weight Hazard.** Use appropriate pallet jack(s), lifting devices, and/or equipment, adequate to lift approximately 750 lbs minimum, and we recommend four (4) or more people to move table. Failure to do so may result in personal injury, death, and/or property damage. When moving the table to its desired location, use proper moving/lifting techniques and/or body mechanics per commercial carrier and/or the facility handling protocol or guidelines; this due to its immense weight and overall size.

3.2 Assembly of cushion to base frame as shown in Figure No. 3.2.1.

Figure 3.2.1

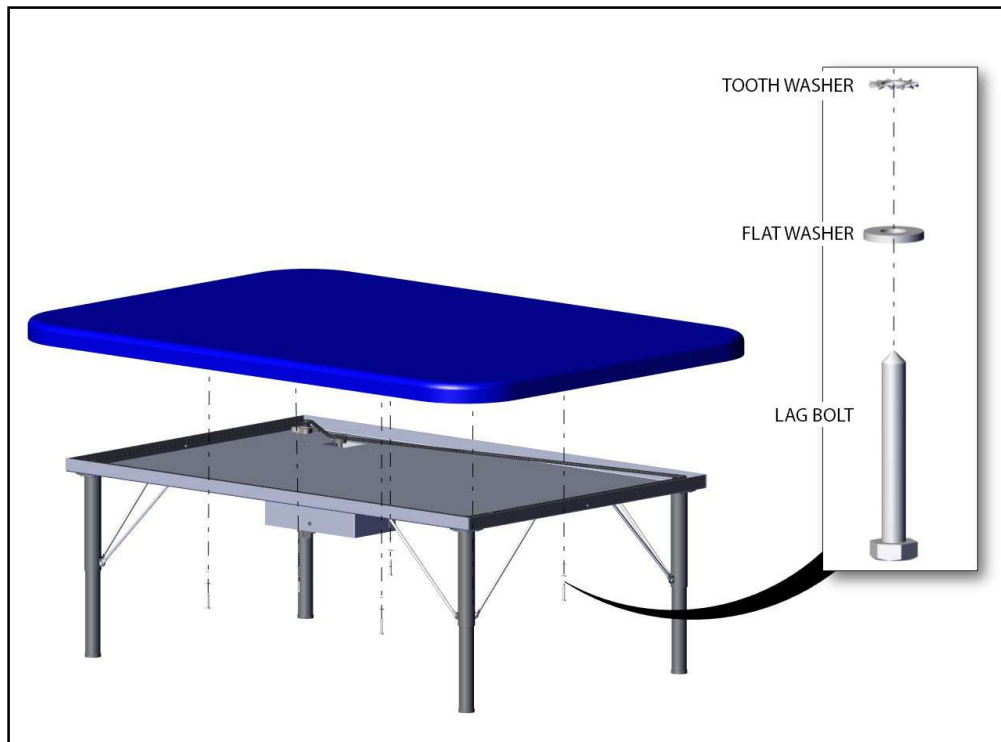

3.3 The mat table should be placed in a location based on its intended use. Position the table in an area having flat/level floors so that the table is not distorted out of alignment. By following the aforementioned instructions, the mat table will function as intended to achieve maximum stability.

3.4 **DO NOT** move the table with a patient on the table.

3.5 Connect or plug-in the power cord to a properly grounded 115 Volt AC receptacle, conforming to the relevant state and nationally recognized electrical codes, and follow the procedure outlined in the Safety/Precautionary Instructions.

3.6 The power supply cord serves as a disconnect device or as the on/off switch. Do not unplug by pulling on the cord. To unplug, grasp the plug, not the cord. **DO NOT** handle plug with wet hands. The receptacle shall be installed near the table and shall be easily accessible.

3.7 Arrange power supply cord away from the traffic area and where it will not be tripped over.

3.8 **DO NOT** use with an extension cord.

3.9 Upon connecting the power supply cord to a grounded receptacle, test mat table to determine electrical functionality.

3.10 **STAY ALERT**, be careful and use common sense.

4.0 **SAFETY/PRECAUTIONARY INSTRUCTIONS**

4.1 Once again, please have anyone who is authorized to use this table read, understand, and practice the safety and precautionary instructions recommended in this user manual. All operators should use common sense, know and fully understand the hazards and risks associated with using and/or operating this Tri W-G, Inc. table prior to operating it.

4.2 **NEVER LEAVE THE PATIENT UNATTENDED.** Close attention is necessary when patients are children and/or disadvantaged.

4.3 Never place ones hand or feet, nor the patients' hand or feet, near any of the working mechanisms on the table when raissing or lowering the table. **DO NOT** place or leave objects or items of any kind underneath the base frame of the table at any time; example: foot stool left under table when the table frame is lowered.

4.4 Whenever you see this symbol:  it signifies "Caution", and is used as a "General Warning Sign"; You and/or Your Patients' Safety is Involved.

4.5 During table operation, immediately stop the table operation, if anything unusual is observed or unusual sounds are heard coming from the table.

4.6 **DO NOT** use this table to play on or as a play area, no matter what the age of the patient or individual may be. It is a Class I Medical Device, called a mat table. And **DO NOT** store or allow any object, of any kind, under the table at any time. No medical claims are made with regard to a patient using the device. Tri W-G,[®] Inc. shall not be liable for any damage, death or injury caused, directly or indirectly, from the misuse of this device/table; and the user shall indemnify Tri W-G,[®] Inc. from and against all costs, damages and expenses (including legal expenses) arising from any such misuse.

4.7 **MOTOR ENCLOSURE (COVER) REMOVAL.** All repair should be performed by trained or certified service personnel. This is also true for removing the motor enclosure ("cover") due to the potential shock hazard in doing so. The qualified service technician must follow the steps below to remove the cover to avoid a hazardous situation occurring:

Step 1-- Disconnect the power cord from the live main receptacle attached to the mat table, as shown in Figures 4.7.1 and 4.7.2.

Figure 4.7.1

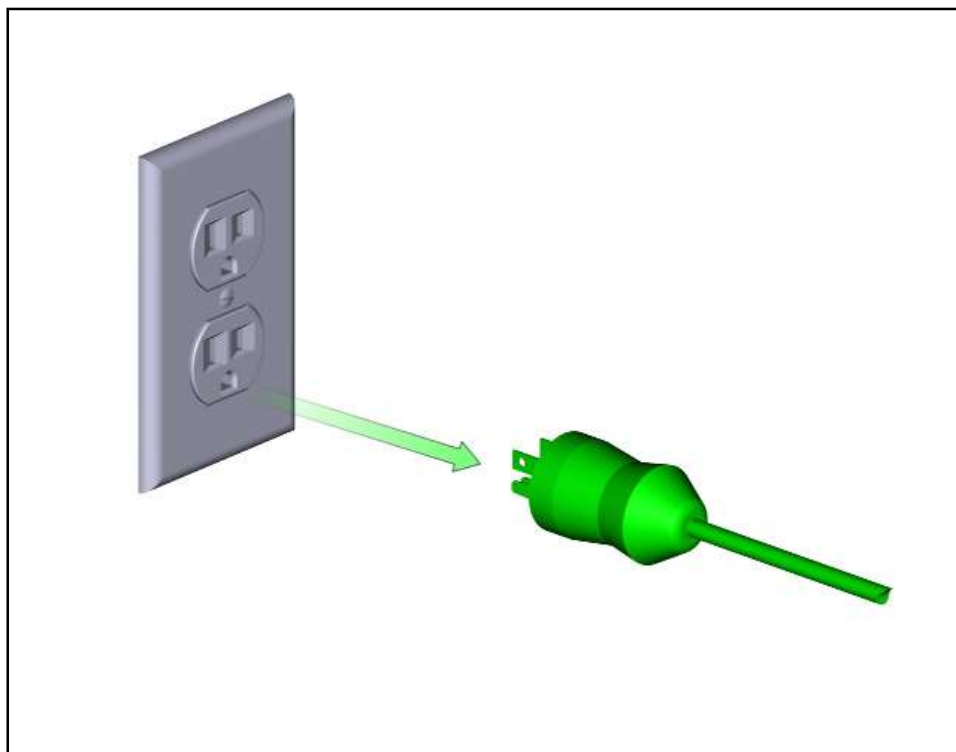

Step 2-- Power cord should no longer be connected to a power source, as shown in Figure 4.7.2.

Figure 4.7.2



Step 3-- Remove power cord from the appliance in-let, as shown in Figure 4.7.3.

Figure 4.7.3

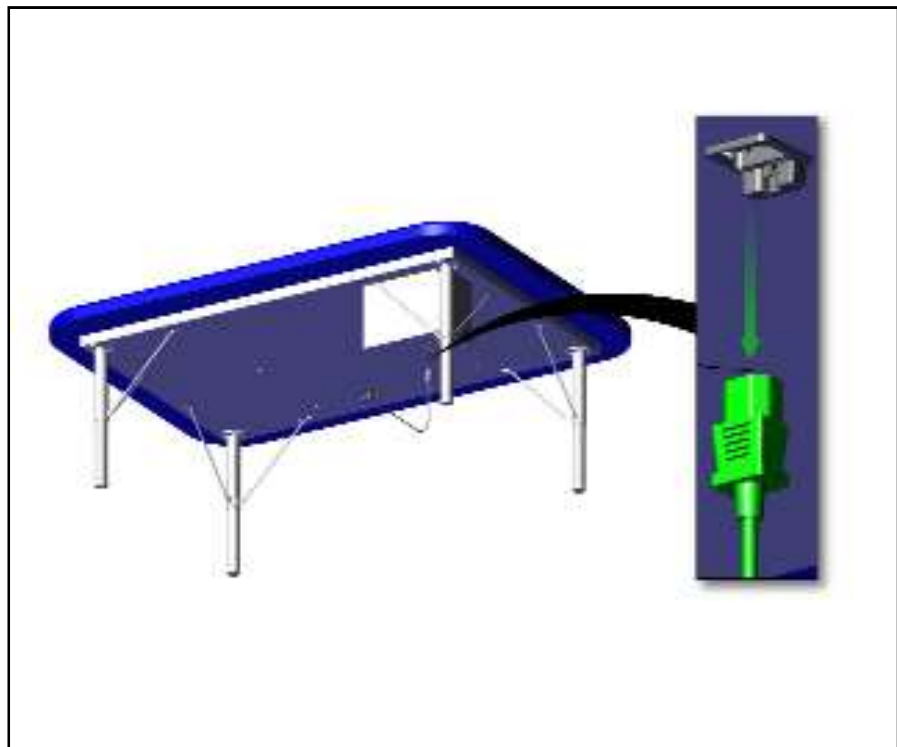

Step 4-- Remove the the five screws from the motor enclosure cover, as shown in Figure 4.7.4.

Figure 4.7.4

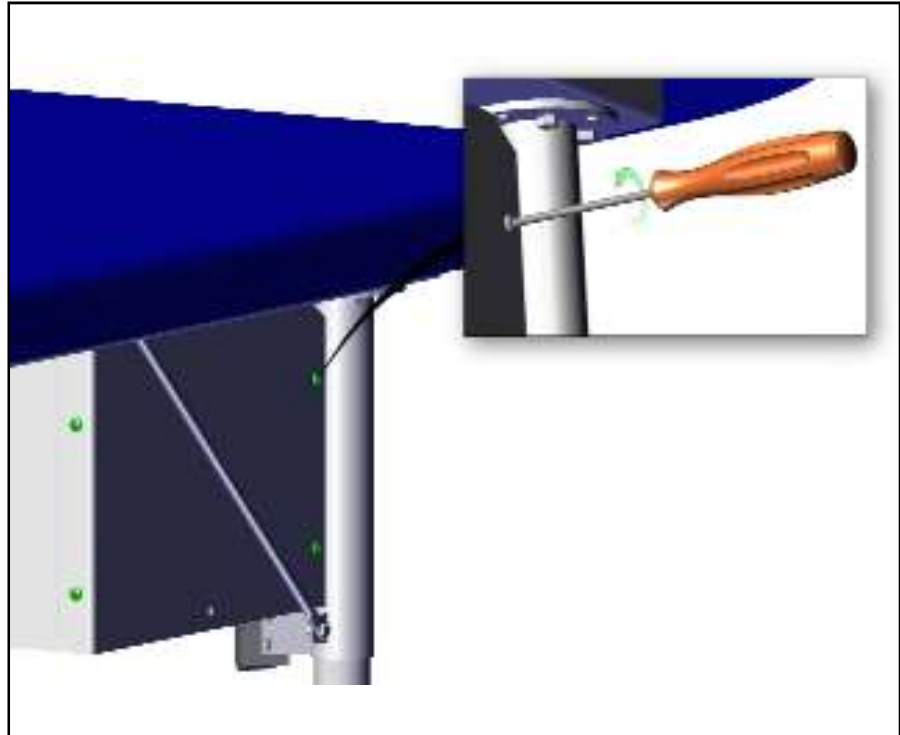

Step 5-- Remove the cover from the motor enclosure, as shown in Figure 4.7.5. Any repair should be performed by trained or certified service personnel.

Figure 4.7.5



4.8 **FUSE REPLACEMENT** *(located in appliance in-let).*

Step 1-- Disconnect the power cord from the live main receptacle attached to the treatment table, as shown in Figures 4.8.1 and 4.8.2.

Figure 4.8.1

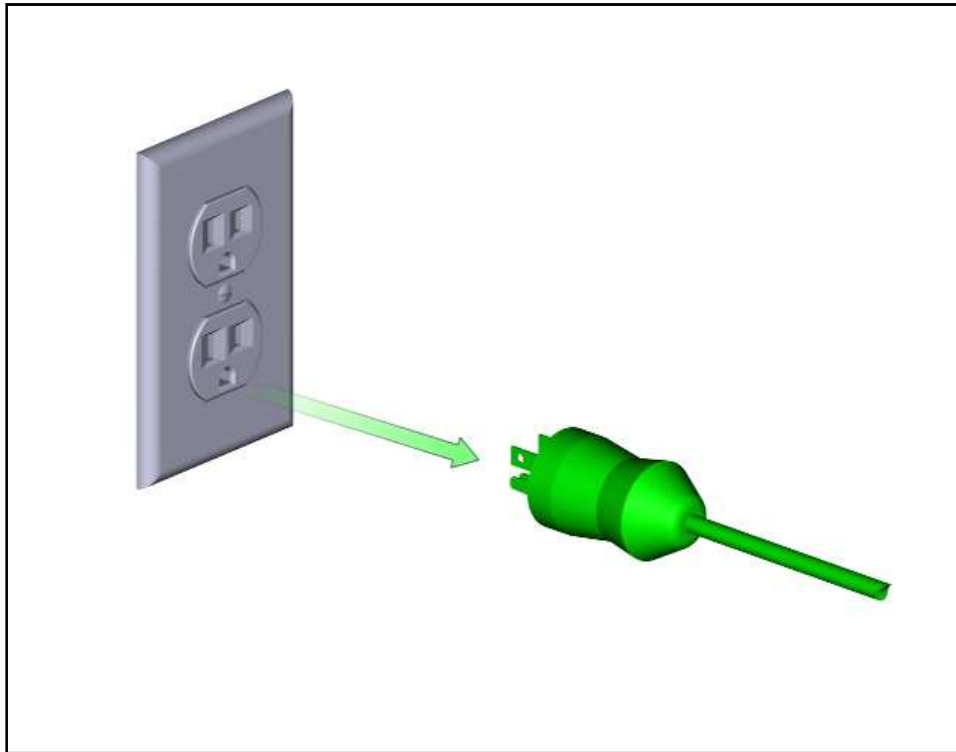

Step 2-- Power cord should no longer be connected to a power source, as shown in Figure 4.8.2.

Figure 4.8.2



Step 3-- Remove power cord from the appliance in-let, as shown in Figure 4.8.3.

Figure 4.8.3

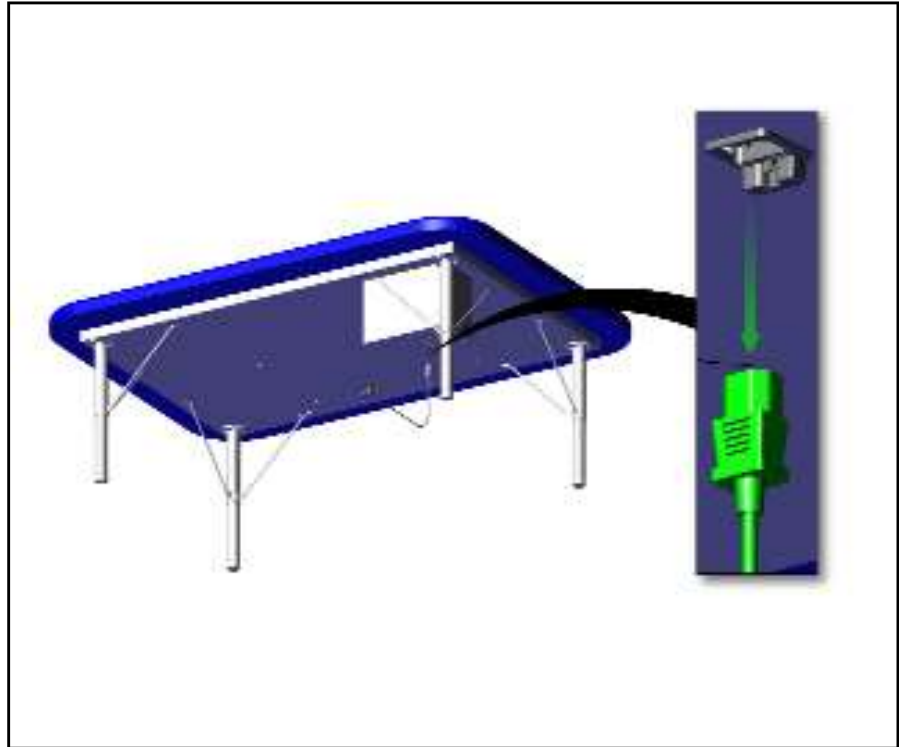

Step 4-- Remove fuse holder from appliance inlet, as shown in Figure 4.8.4.

Step 1--Press in on release tab as indicated by green arrow.

Step 2--Pull fuse holder down as indicated by the green arrow.

Step 3--Remove time-lag fuses and replace with appropriated fuses (PN 900-015-005).

Figure 4.8.4

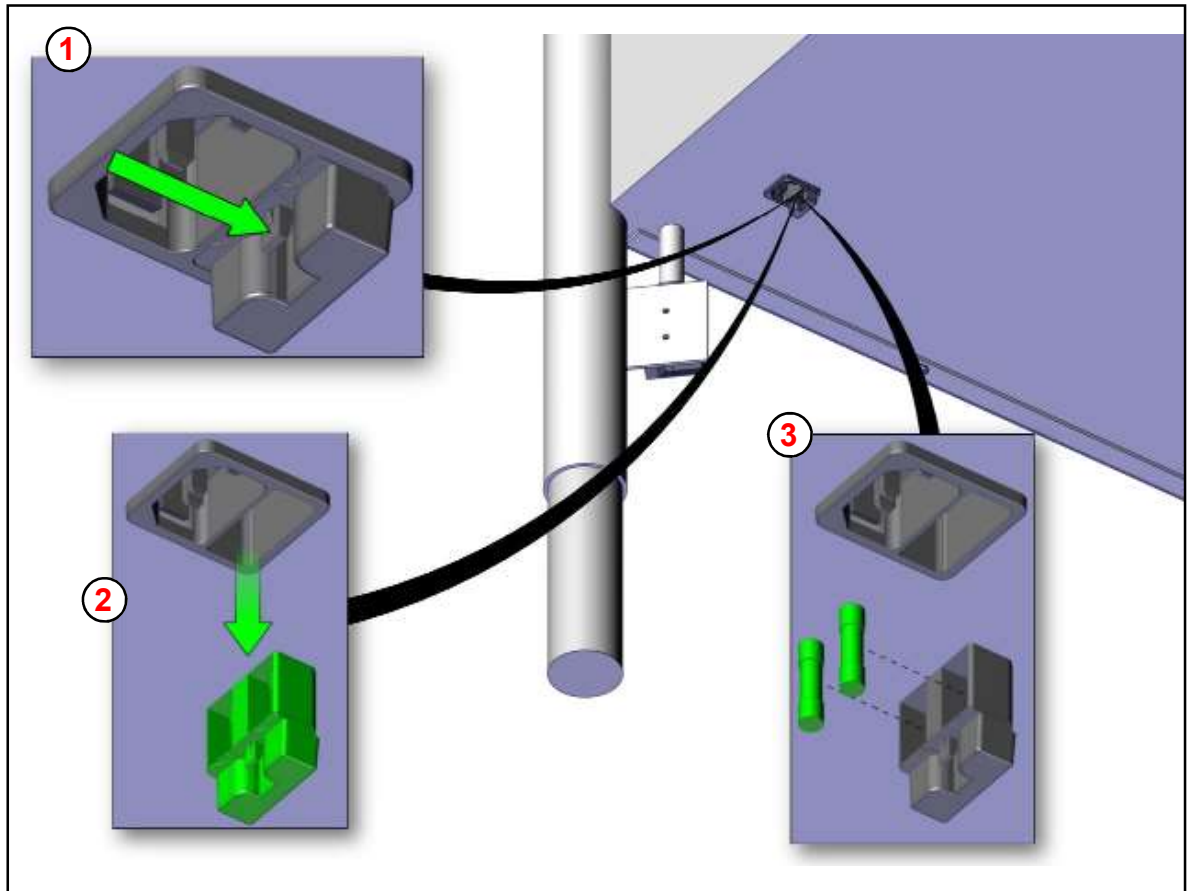

Replacement Fuses: Newark in One Part No. 50M5468 (0001.2511)
UL Standard 248-14, UL File Number E41599
Rated Voltage: 250VAC, 150VDC; Rated Current: 5A; Breaking Capacity: 500A-1500A;
Characteristic: Time-Lag; Admissible Ambient Air Temp: -55C to 125C; Climatic Category: 55/125/21
ACC to IEC 60068-1; Tube Material: Ceramic; Endcap Material: Nickel Plated Copper Alloy;
Unit Weight: 1.16 G; Storage Conditions: 0-60C, Max 70% R.H.

Call Tri W-G[®] Service Dept at 1-800-437-8011 or an electrician for assistance.

5.0 INTENDED USE

It is a powered table intended for medical purposes (Class I Device) that is an electrically operated flat surface table that can be adjusted to various positions. It is used by patients with circulatory, neurological, or musculoskeletal conditions to increase tolerance to an upright or sitting position; [21CFR890.3760]. At no time should patients be left unattended on the table.

6.0 INTENDED USER PROFILE

It is intended to be used by Licensed Physical Therapists, Assistant Physical Therapists, Occupational Therapists, Assistant Occupational Therapists, and licensed rehab specialists utilizing a prescribed therapeutic protocol, written by a licensed medical practitioner or physician. It is not intended to be used by maintenance staff, installers, patients and/or lay persons.

7.0 INTENDED CONDITIONS of USE

Intended for use in professional healthcare facility environments (e.g., general or rehab hospitals, clinics, professional medical practices, limited care and multiple treatment facilities) where operators with medical training are continually available when patients are present and trained in its intended use. It is not to be used in a home environment or dwelling place in which a patient lives or other places where patients are present; and may not be used in areas with unrestricted public access and rooms designed as wet areas.

8.0 OPERATING INSTRUCTIONS

8.1 Adjust Height--To raise or lower the table using the footswitch, use one's foot and press on the UP or DOWN button. Always check to make absolutely sure there are no objects under the table or near the top frame when lowering or raising the table. It takes very little time to make a second check if you have left the area prior to your next hi-lo adjustment. Never leave the table with a patient on it. An example of an object that can easily make its way under the table is a step stool; and there are many more objects that lie around or are near a table that can get shoved under the table.

8.2 Duty Cycle--System is an intermittent operation; 1 minute ON/10 minutes OFF; Auto-Thermally Protected.

8.3 Capacity--The table is intended to support **600 lbs** (272 Kilograms), evenly distributed over the table top. Maximum static uniform load on kneegatch and backrest is 175 lbs (79 Kilograms).

8.4 User--**Never** allow the patient to operate the mat table. Only trained personnel authorized to use the table should operate the mat table.

9.0 MAINTENANCE

9.1 Due to normal wear, it may be necessary to replace the footswitch or the power cord. Call our customer service for replacement parts and/or installation instructions.

9.2 Cleaning the vinyl cover is accomplished with water and a mild detergent. Do not use Peroxide, Hylex, Lysol, strong or aggressive cleaning agents as they will discolor and reduce the life of the vinyl. The water used for cleaning, including chemical additives, must be pH-neutral. A soft dust cloth will work to remove dust and lint on the steel frame when necessary. The mat table frame should be wiped down using a dry cloth to remove dust/lint on a regularly scheduled basis--keep free of dust. Cleaning the cover should be done after each patient procedure is complete and prior to new patient being placed on the table.

9.3 Inspection and maintenance/repair shall be made on a regular and/or periodic basis, which shall encompass the entire table. This includes, but is not limited to, the following: all moving parts, cushion (vinyl, velcro, stitching, foam), broken welds and/or cracks, bushings, nuts, bolts, screws, footswitch, power cord, wire holding clips and snaps, etc., to name a few. Replacement of worn or failed parts shall be replaced immediately, or as is deemed necessary. All inspections and maintenance/repair activities shall be recorded by owner facility. Operator should notify all users to discontinue using the table if the safety of operator and/or patient is eminent. Call Tri W-G,[®] Inc. Service Dept at 1-800-437-8011 and report any potential safety concerns.

9.4 Any repair should be performed by trained or certified service personnel.

10.0 SYMBOLS, INDICATORS, and DEGREE OF SAFETY



Mandatory action sign; Read User Manual Caution: General Warning Sign.



Mandatory action sign; Read User Manual Caution: General Warning Sign.



Read User Manual; contains useful information.



General Warning Sign.



Type B Equipment: Equipment providing a particular degree of protection against electric shock, particularly regarding allowable leakage current and reliability of the protective earth connection.



Protective Earth Ground: This product is Class I equipment in which protection against electric shock does not rely on BASIC INSULATION only, but which includes an additional safety precaution in that means are provided for the connection of the EQUIPMENT to the protective earth conductor in the fixed wiring of the insulation in such a way the ACCESSIBLE METAL PARTS cannot become LIVE in the event of a failure of the BASIC INSULATION.



Earth (ground).

- WATER Protection against harmful ingress of water--Prevent mat table from being subjected to water sprays or water hosing.
- ANESTHETICS Not suitable for use in the presence of a flammable anesthetic mixture with air or oxygen or nitrous oxide.
- ELEC. RATING Input: TG.1532--115VAC; 3.4 A Max; 60 Hz
 TG.1534--115VAC; 3.4 A Max; 60 Hz
 TG.1536--115VAC; 3.4 A Max; 60 Hz
 TG.1562--115VAC; 3.4 A Max; 60 Hz
 TG.1564--115VAC; 3.4 A Max; 60 Hz
 TG.1566--115VAC; 3.4 A Max; 60 Hz
- DUTY CYCLE System is an intermittent operation; 1 minute ON/10 minutes OFF; Auto-Thermally Protected.



Medical Device



Date of Manufacture Expressed as: YYYYMMDD

11.0 **WARNINGS and USAGE HINTS**

Any serious incident that has occurred in relation to this device should be reported to Tri W-G and the competent authority of the Member States in which the use and/or patient is established.

Please make note of the meaning of the following warnings and usage hints:

Note: indicates usage information that helps the user to use the product correctly and efficiently or to understand the properties of the product.

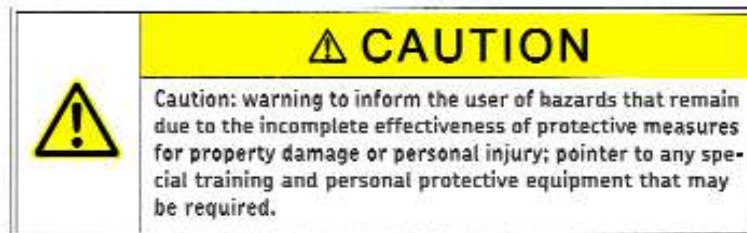

12.0 OTHER HAZARDS

The manufacturer has constructively, and with protective measures, minimized the effects of existing hazards; as these “**ATTENTION/NOTICES**” are used to indicate areas that warranty the operator and/or user’s attention. Pay attentions to the following hazards and the possible countermeasures given in the following:

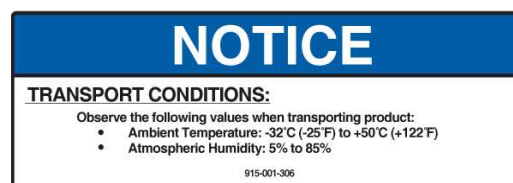
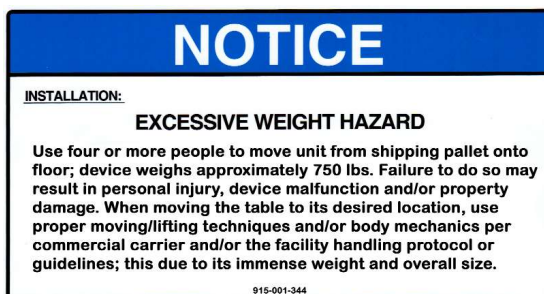
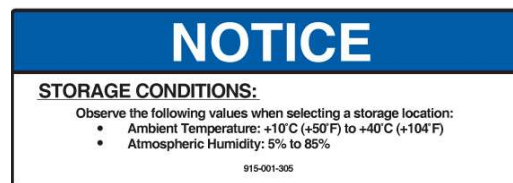
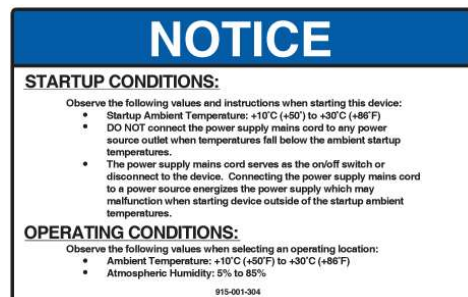
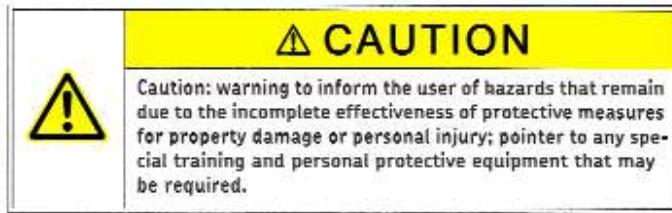

12.0 OTHER HAZARDS CONT'D

To ensure safety, the operator and/or user of this device must under all circumstances adhere to the following “**WARNING**” directives as they indicate a source of potential hazards that could lead to serious injury or death.

	⚠ WARNING
	Warning: To avoid risk of electric shock, this device must only be connected to a supply mains with a protective earth (ground).

	⚠ WARNING
	<p>Warning: Warnings regarding significant RISKS of reciprocal interference, potential electromagnetic interference “EMI” and/or other interference that may come about as the result of using this device during specific investigations or treatments; and advice on how to avoid or minimize such interference. Operator must read the user manual prior to using the device, become familiar with its intended use, as well as, what is not appropriate when using this device near reciprocal interferences, patient(s) and/or others on or near the device. This device generates, uses and can radiate radio frequency energy and, if not installed and used for its intended purpose, in accordance with the user manual instructions, may cause harmful interference to other devices in the surrounding area. Interference can lead to data loss, problems with computers, monitors, cell phones, various other wireless applications, and signal interruptions, to name a few. This device has not been tested for EMI; therefore, Tri W-G provides no guarantee that EMI will not occur in a particular installation. If this equipment does cause harmful interference to other devices, which can be determined by turning the equipment off and on, the user is encouraged to try to correct the interference by one or more of the following measures:</p> <ul style="list-style-type: none">*Relocate the device*Increase the separation between various devices and/or equipment.*Connect the device into a receptacle on a different circuit.*Call a facility service technician for assistance.

	⚠ WARNING
	<p>Warning: This warning is to address HAZARDS that can result from unauthorized modifications of this device, which are as follows:</p> <ul style="list-style-type: none">* Do Not modify this device without the written consent of Tri W-G, Inc.* Any modification authorized by Tri W-G, Inc. must undergo appropriate inspection and testing to applicable regulatory standards this device is certified to; this is an absolute requirement to ensure continued safe use of this device.

13.0 SPECIFICATIONS:

Item No. TG.1532: Width-4'; Length-7';
Ht. Range- 18.50"-29.50" to top of cushion (*heights nominal*)

Item No. TG.1534: Width-5'; Length-7';
Ht. Range- 18.50"-29.50" to top of cushion (*heights nominal*)

Item No. TG.1536: Width-6'; Length-8';
Ht. Range- 18.50"-29.50" to top of cushion (*heights nominal*)

Item No. TG.1562: Width-4'; Length-7';
Ht. Range- 23.25"-34.75" to top of cushion (*heights nominal*)

Item No. TG.1564: Width-5'; Length-7';
Ht. Range- 23.25"-34.75" to top of cushion (*heights nominal*)

Item No. TG.1566: Width-6'; Length-8';
Ht. Range- 23.25"-34.75" to top of cushion (*heights nominal*)

Weight Capacity: A maximum static uniform load of 600 lbs.

Frame: Heavy gauge steel.

Finish: Polyurethane Pearl Grey standard; Porcelain optional.

Upholstered Top: 2" polyfoam with vinyl cover standard; Vinyl Coated Nylon & Herculite, optional.
Vinyl conforms to California Fire Code 117.

Footswitch: Footswitch for adjusting various table positions is pneumatic, no voltage involved.
Power supply serves as main disconnect device.

Electrical: Input: TG.1532--115VAC; 3.4 A Max; 60 Hz
TG.1534--115VAC; 3.4 A Max; 60 Hz
TG.1536--115VAC; 3.4 A Max; 60 Hz
TG.1562--115VAC; 3.4 A Max; 60 Hz
TG.1564--115VAC; 3.4 A Max; 60 Hz
TG.1566--115VAC; 3.4 A Max; 60 Hz

Approvals: This medical device has been tested to the following standards:
UL[®] 2601-1
IEC 60601-1
CAN/CSA C22-2 No. 601.1

Fuse: Newark in One Part No. 50M5468 (0001.2511)
UL Standard 248-14, UL File Number E41599
Rated Voltage: 250VAC, 150VDC; Rated Current: 5A; Breaking Capacity: 500A-1500A;
Characteristic: Time-Lag T; Admissible Ambient Air Temp: -55C to 125C; Climatic Category: 55/125/21
ACC to IEC 60068-1; Tube Material: Ceramic; Endcap Material: Nickel Plated Copper Alloy;
Unit Weight: 1.16 G; Storage Conditions: 0-60C, Max 70% R.H.

Replacement Fuses: Unplug mains power source prior to removing fuses and during installation of fuses to avoid electrical shock. See Section 4.8, Fuse Replacement, Page 7. Call Tri W-G[®] Service Dept at 1-800-437-8011 or an electrician for assistance.

14.0 STARTUP CONDITIONS:

14.1 Observe the following values and instructions when starting this device:

- Startup Ambient Temperature: +10° C (+50° F) to +30° C (+86° F)
- **DO NOT** connect the power supply mains cord to any power source outlet when temperatures fall below the ambient startup temperatures.
- The power supply mains cord serves as the on/off switch or disconnect to the device. Connecting the power supply mains cord to a power source energizes the power supply which may malfunction when starting device outside of the startup ambient temperatures.

15.0 OPERATING CONDITIONS:

15.1 Observe the following values when selecting a operating location:

- Ambient Temperature: +10° C (+50° F) to +30° C (+86° F)
- Atmospheric Humidity: 5% to 85%

16.0 STORAGE CONDITIONS:

16.1 Observe the following values when selecting a storage location:

- Ambient Temperature: +10° C (+50° F) to +40° C (+104° F)
- Atmospheric Humidity: 5% to 85%

17.0 TRANSPORT CONDITIONS:

17.1 Observe the following values when transporting product:

- Ambient Temperature: -32° C (-25° F) to +50° C (+122° F)
- Atmospheric Humidity: 5% to 85%

18.0 NOTICE/SERVICE:

18.1 Design changes may have occurred in the product since this user manual was published. The technical information found within this manual was correct at the time this user manual was approved for publication.

18.2 Tri W-G,[®] Inc. does not assume any risk or liability for attachments, or their effects on this device, if the attachments are not manufactured, sold by, and expressly approved by Tri W-G,[®] Inc. Tri W-G,[®] Inc. also informs the end user and/or anyone else “**Not-to-Use**” any attachments, on this device, that are not approved in writing by Tri W-G,[®] Inc.

18.3 When parts are required, use only those parts authorized by Tri W-G,[®] Inc.

18.4 If any information contained in this publication is not understood, the user should contact Tri W-G,[®] Inc. for assistance at 1-800-437-8011.

18.5 **DO NOT** perform any electrical or general service on the mat table prior to disconnecting the power supply cord which serves as the on/off switch to the mat table.

19.0 TROUBLE SHOOTING



- 19.1 Check power cord connection to main power source.
- 19.2 Make sure main power source is receiving power.
- 19.3 Auto Thermal Protector may have activated, and you must allow the system to cool down. Duty Cycle is an intermittent operation; 1 minute ON/10 minutes OFF; Auto-Thermally Protected.
- 19.4 Check appliance in-let fuses making sure they are not burned out. If they are, replace with new fuses. See Section 4.8, Fuse Replacement, Page 6.
- 19.5 Tried everything and nothing works to resolve the dilemma--contact Tri W-G,[®] Inc. Customer Service by calling 1-800-437-8011.

20.0 REPLACEMENT PARTS LOCATION SCHEMATIC

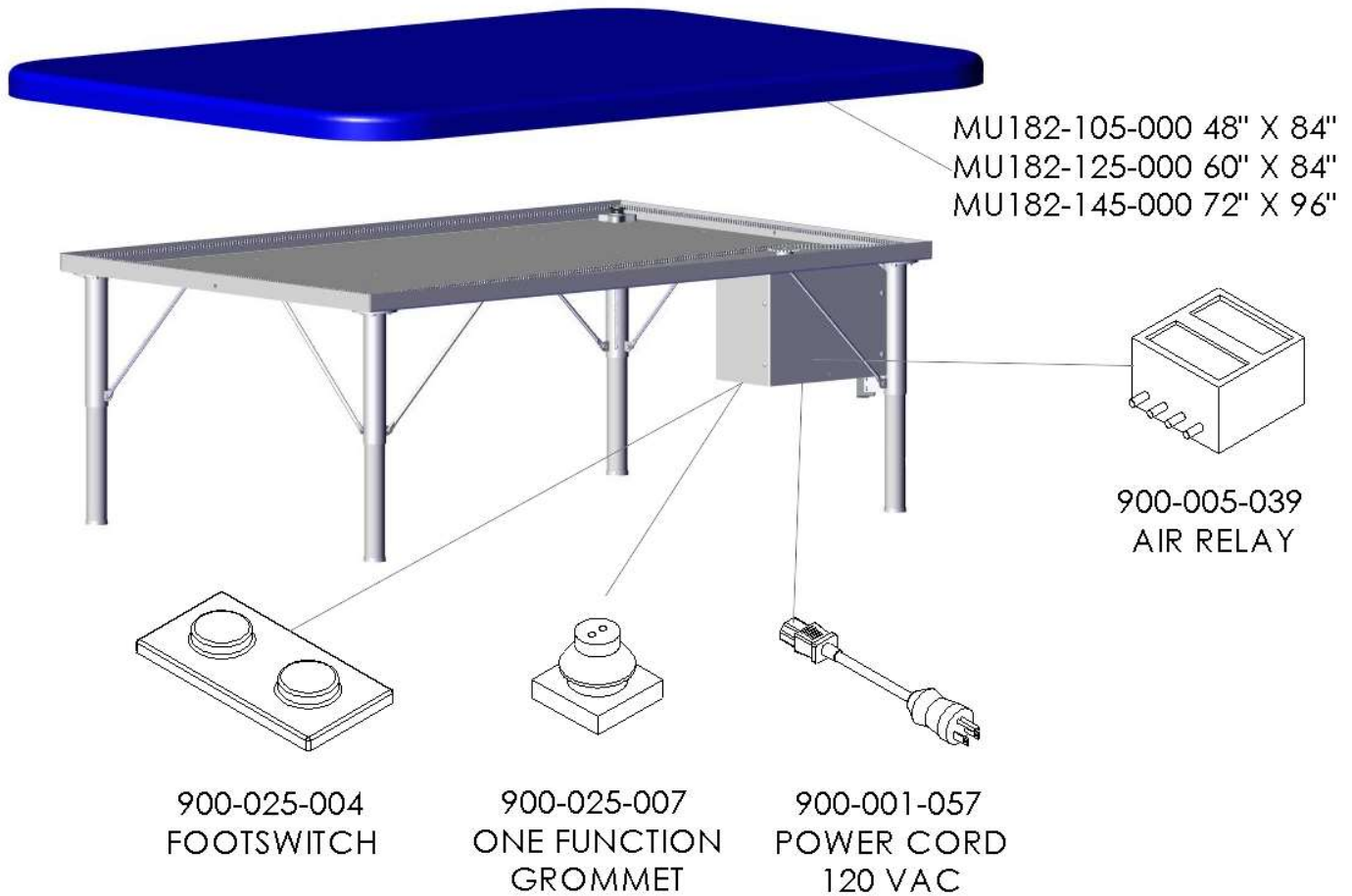
This replacement parts location schematic shows the service parts which may require service sometime in the future as the result of normal wear and tear. These parts can be ordered from the Tri W-G,® Inc. Service Dept by calling 1-800-437-8011. In the event any additional information is required, beyond what is shown below, please contact the Tri W-G,® Inc. Service Dept; which may include but not limited to--electrical diagrams, general service parts such as washers, bolts, connectors, etc.; and questions in general.

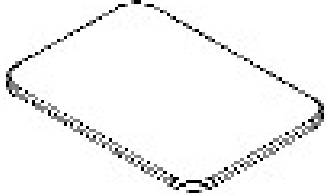
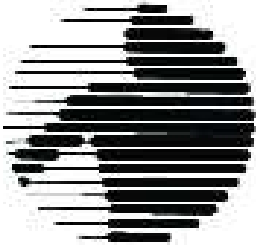
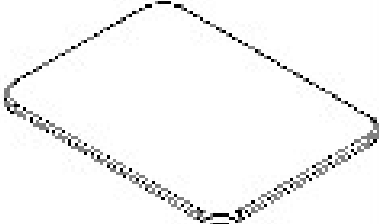
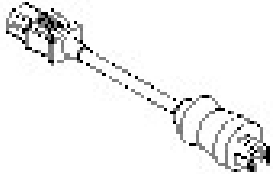
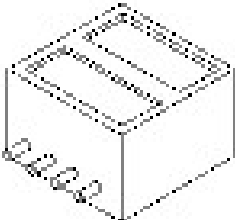
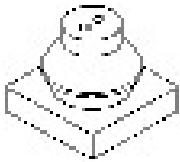
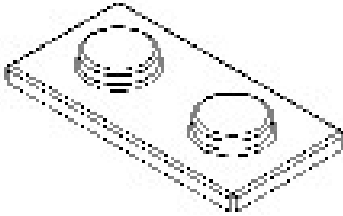

20.1 **REPLACEMENT PARTS**

 <p>MU182-105-000 ONE SECTION CUSHION 48" X 84"</p>  <p>900-015-005 5 AMP FUSE</p>	 <p>MU182-125-000 ONE SECTION CUSHION 60" X 84"</p>  <p>900-025-007 ONE FUNCTION GROMMET</p>	 <p>MU182-145-000 ONE SECTION CUSHION 72" X 96"</p>  <p>900-001-057 POWER CORD 120 VAC</p>
 <p>900-005-039 AIR RELAY</p>	 <p>900-025-007 ONE FUNCTION GROMMET</p>	 <p>900-024-004 FOOTSWITCH</p>

21.0 SYSTEM SCHEMATIC

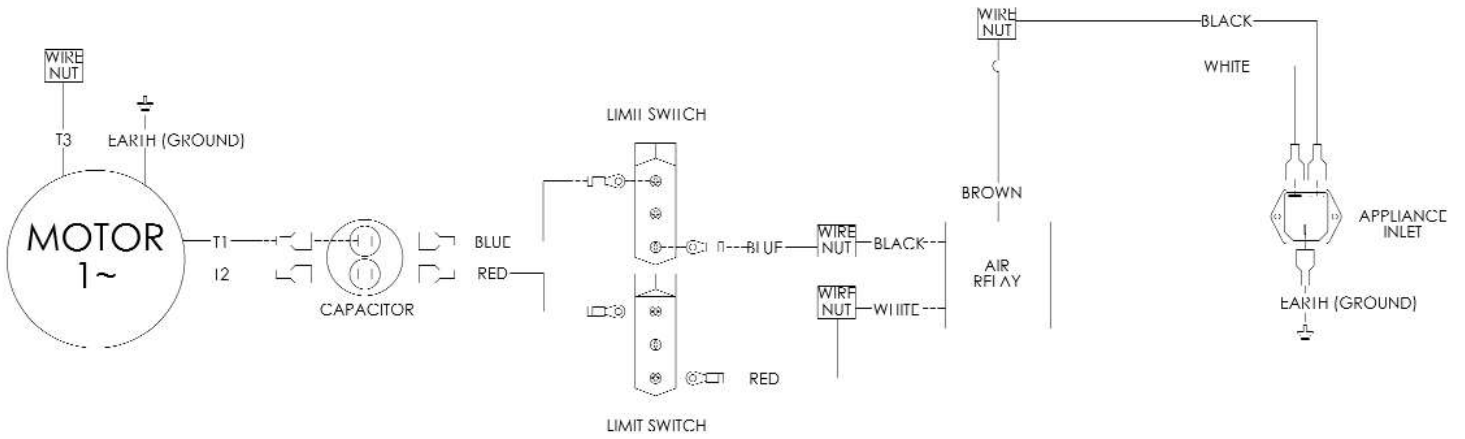

22.0 DISPOSING OF THIS MEDICAL DEVICE

Deterioration in function, failure and/or the medical device has reached its life span, as a result of aging, wear, repeated use, or it has been determined to decommission it and/or dispose of it, must be done in a technically proper manner and in accordance with international, national, regional and/or local environmental regulatory requirements for disposing of medical devices. The owner of this medical device is responsible for its proper disposal.

LIMITED WARRANTY

This Product or Part is sold by Tri W-G,[®] Inc. under the limited warranties set forth in the following paragraphs. Such warranties are extended only with respect to the Purchase of the Product or Part as new merchandise directly from Tri W-G,[®] Inc. or a Tri W-G,[®] Inc. Authorized Dealer and are extended to the ultimate customer purchaser of the Tri W-G,[®] Inc. Product or Part.

Tri W-G,[®] Inc. warrants that each Product or Part sold hereunder shall be free of defects in material and workmanship for the Product warranty period identified as follows:

Ten Years: structural frame.

Two Years: operating system and major moving components.

One Year: hand and foot controls; upholstery.

(Please note the aforementioned limited warranty is limited to original owner and not transferable.)

in the case of Products and twelve months in the case of Parts from the date of delivery from Tri W-G,[®] Inc. or an authorized Tri W-G,[®] Inc. Dealer, whichever is later. Should defects appear in any products subject to this limited warranty and Parts subject to this limited warranty sold hereunder within the respective limited warranty period, Tri W-G,[®] Inc. will repair or replace under the terms of this limited warranty any defective Part or Parts or provide new or remanufactured Parts when the defective Part or Parts are returned to Tri W-G,[®] Inc. facilities at Buyer's expense upon (20) days prior written notice to Tri W-G,[®] Inc. Buyer will be charged for any replacement Parts when shipped to Buyer by Tri W-G,[®] Inc. When the defective Parts are returned to Tri W-G,[®] Inc. pursuant to Tri W-G,[®] Inc. returned goods authorization, charges will be waived.

This limited warranty does not apply to any Products or Parts which have been damaged through misuse, negligence or accident (including shipping damage) on the part of Buyer or any third party. This limited warranty does not apply to any Product in which Parts other than replacement Parts or Parts approved by Tri W-G,[®] Inc. have been used if said Parts are or may be the cause of failure.

FOR ANY BREACH OF WARRANTY, EXPRESSED OR IMPLIED, THE LIABILITY OF TRI W-G,[®] INC. IS HEREBY EXPRESSLY LIMITED, AND SUBJECT TO THE TERMS HEREIN, TO THE REPAIR OR REPLACEMENT OF ANY PRODUCT OR PART WHICH SHALL APPEAR TO BE DEFECTIVE IN THE OPINION OF TRI W-G,[®] INC. THIS WARRANTY IS IN LIEU OF ALL OTHER WARRANTIES, EXPRESSED OR IMPLIED, INCLUDING WARRANTIES OF MERCHANTABILITY AND FITNESS FOR A PARTICULAR PURPOSE. IN NO EVENT SHALL TRI W-G,[®] INC. BE LIABLE FOR ANY SPECIAL, INCIDENTAL OR CONSEQUENTIAL DAMAGES. NO CLAIM FOR BREACH OF WARRANTY FOR PRODUCTS OR PARTS FURNISHED HEREUNDER SHALL BE ASSERTED AGAINST TRI W-G,[®] INC. MORE THAN TWENTY (20) DAYS AFTER THE EXPIRATION OF THE WARRANTY PERIOD.

DISCLAIMER

Every effort has been made to use accurate photography, drawings, product specifications and descriptions at the time of printing.

The contents of this publication are the copyright of the publisher and may not be reproduced unless prior written permission is granted. Every effort has been made to ensure the accuracy of the information contained in this Operator's Manual, but no liability can be accepted for any loss or damage whether direct, indirect, or consequential arising out of the use of the information contained herein. The label(s) on any of the products/components supercedes the copy and/or data that is in this User Manual. Copy, data and/or print on serial tags and labels attached to any of Tri W-G products and/or components supplied by other vendors used in Tri W-G products, shall supersede, any and all copy, data and/or print stated in this User Manual. However, because of continuous progressive product improvements, all specifications and descriptions are subject to change without prior notice.

Tri W-G® is a registered trademark of Tri W-G, Inc. UL® is a registered trademark of Underwriters Laboratories, Inc. All other company and product names are trademarks or registered trademarks of their respective owners.

(This page intended to not be used)

(This page intended to not be used)

(This page intended to not be used)

Manufactured and Distributed by:



Phone: 1-800-437-8011
Email: triwg@triwg.com
215 12th Avenue NE
PO Box 905
Valley City, ND 58072-0905