



IV Sets and Access Devices Product Catalog

Effective August, 2017

Contents

- Stopcocks and Manifolds 1-2
- ULTRAPORT™ and ULTRAPORT zero Luer-Activated
Stopcocks 3
- Open Lumen and Swabbable Closed System
SAFEPORT™ Sets 4
- Anesthesia Accessories 5
- Anesthesia Disinfection Workstation 5
- ULTRAPORT Luer-Activated Stopcock Extension Sets 6
- Open Lumen SAFEPORT Manifold Extension Sets 7
- Stopcock Extension Sets and
Anesthesia IV Administration Sets 8
- ULTRAPORT Stopcock Anesthesia Sets 9
- Open Lumen SAFEPORT Manifold Anesthesia Sets 10
- Swabbable SAFEPORT Manifold Anesthesia Sets 11
- Basic IV Administration and Extension Sets 12-18
- Filtered Extension Sets 19-20
- Blood Administration Sets 21-22
- Burette Sets 22
- RATE FLOW® Regulator Administration Sets 23
- Special Accessories 24
- Injection and Replacement Caps 25
- CARESITE® Needleless (LAD) System 26-30
- ULTRASITE® Needleless Valve System 31-39
- SAFELINE® Needleless System 40-44
- InVision-Plus® Needleless System with Neutral Advantage
Technology 45-46

Description	Product Code	REF Number	Unit Per cs
-------------	--------------	------------	-------------

DISCOFIX® Stopcocks

Components on this page are not made with DEHP or natural rubber latex.

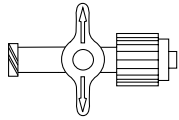

One-way stopcock with female luer lock port and SPIN-LOCK® connector, port covers. Lipid-resistant. Priming volume: 0.20 mL

D100

455980

100

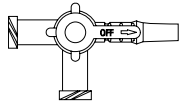

Three-way stopcock with two female luer lock ports and male luer slip connector, port covers. Lipid-resistant. Priming volume: 0.26 mL

D201

455991

100

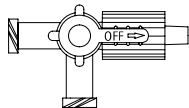

Three-way stopcock with two female luer lock ports and one SPIN-LOCK connector, port covers. Lipid-resistant. Priming volume: 0.26 mL

D300

456003

100

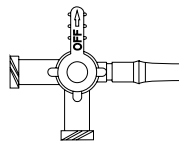

Four-way stopcock, two female luer lock ports and male luer slip connector, port covers. Lipid-resistant. Priming volume: 0.26 mL

D401

456006

100

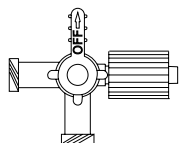

Four-way stopcock, two female luer lock ports and SPIN-LOCK connector, port covers. Lipid-resistant. Priming volume: 0.26 mL

D500

456020

100

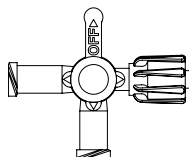

High-Flow, four-way stopcock, two female luer lock ports and SPIN-LOCK connector, port covers. Lipid-resistant. Priming volume: 0.32 mL

D600

456060

100

Description	Product Code	REF Number	Unit Per cs
-------------	--------------	------------	-------------

Ganged Stopcocks and Manifolds

Components on this page are not made with DEHP or natural rubber latex.

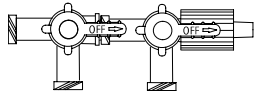

Two-gang, three-way stopcocks with three female luer lock ports and SPIN-LOCK connector, port covers. Lipid-resistant. Priming volume: 0.68 mL. Length: 3 in. (7.6 cm)

D201T

455992

100

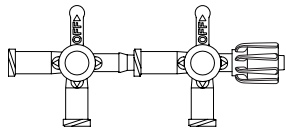

High flow, two-gang, four-way stopcocks, with three female luer lock ports and SPIN-LOCK connector, port covers. Lipid-resistant. Priming volume: 0.65 mL. Length: 3 in. (7.6 cm)

D602HF

456201

25

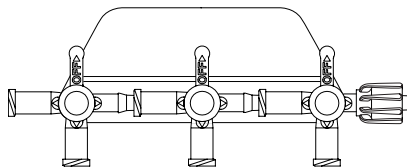

High Flow, three-gang, four-way stopcocks, with four female luer lock ports and SPIN-LOCK connector, port covers. Lipid-resistant. Priming volume: 0.95 mL. Length: 4 in. (10.2 cm)

D603HF

456301

25

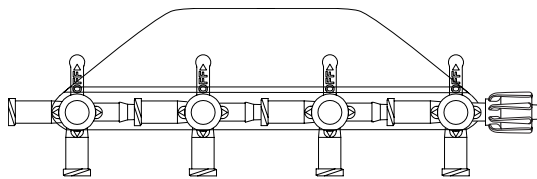

High-Flow, four-gang, four-way stopcocks, with five female luer lock ports and SPIN-LOCK connector, port covers. Lipid-resistant. Priming volume: 1.31 mL. Length: 5 in. (12.7 cm)

D604HF

456401

25

ANESTHESIA IV PRODUCTS

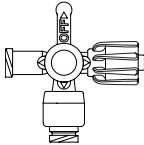
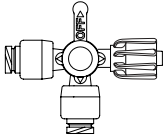
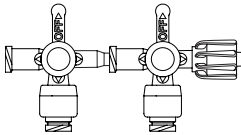
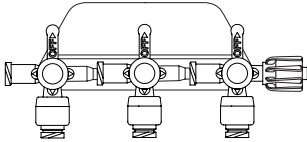
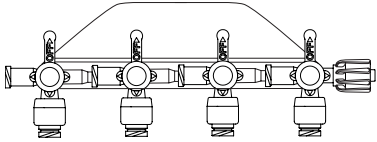
Description	REF Number	Unit Per cs
ULTRAPORT™ and ULTRAPORT zero Luer-Activated Needleless Stopcocks Not made with natural rubber latex, DEHP or PVC. Made of lipid-resistant material.		
		
High-Flow, 4-way ULTRAPORT stopcock with luer-activated swabbable port, female luer lock port and SPIN-LOCK® connector. Stopcock priming volume: 0.5 mL. Sideport priming volume: 0.2 mL.	456501	100
ULTRAPORT zero version of the above stopcock - zero dead space in the stopcock.	457501	100
<hr/>		
		
High-Flow, 4-way ULTRAPORT stopcock with two luer-activated swabbable ports, female luer lock port and SPIN-LOCK connector. Stopcock priming volume: 0.5 mL. Sideport priming volume: 0.2 mL.	456502	100
ULTRAPORT zero version of the above stopcock - zero dead space in the stopcock.	457502	100
<hr/>		
		
Two high-flow, 4-way ULTRAPORT stopcocks with two luer-activated swabbable ports, female luer lock port and SPIN-LOCK connector. Priming volume: 0.8 mL. Sideport priming volume: 0.2 mL.	456202	25
ULTRAPORT zero version of the above stopcock - zero dead space in the stopcock.	457202	25
<hr/>		
		
Three high-flow, 4-way ULTRAPORT stopcocks with three luer-activated swabbable ports, female luer lock port and SPIN-LOCK connector. Priming volume 1.7 mL. Sideport priming volume 0.2 mL.	456302	25
ULTRAPORT zero version of the above stopcock - zero dead space in the stopcock.	457302	25
<hr/>		
		
Four high-flow, 4-way ULTRAPORT stopcocks with four luer-activated swabbable ports, female luer lock port and SPIN-LOCK connector. Priming volume 1.7 mL. Sideport priming volume 0.2 mL.	456402	25
ULTRAPORT zero version of the above stopcock - zero dead space in the stopcock.	457402	25

Description

Product Code

REF Number

Unit Per cs

Open Lumen SAFEPORT™ Sets

Components on this page are not made with DEHP or natural rubber latex.

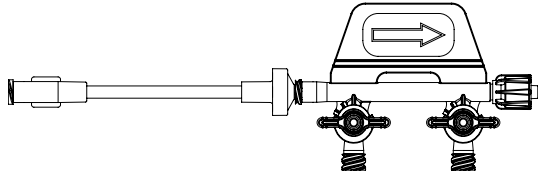

Dual port SAFEPORT with in-line backcheck valve and SPIN-LOCK connector. Approximate priming volume: 1.4 mL Approximate length: 7 in. (17.7 in.)

456520

50

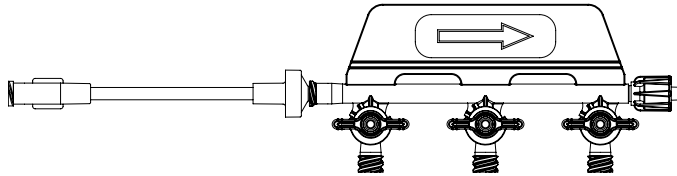

Triple port SAFEPORT with in-line backcheck valve and SPIN-LOCK connector. Approximate priming volume: 1.9 mL Approximate length: 8 in. (20.3 in.)

456522

50

Swabbable Closed System SAFEPORT Sets

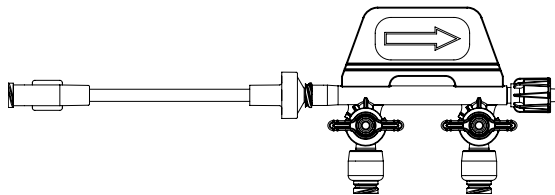

Dual swabbable port SAFEPORT with in-line backcheck valve and SPIN-LOCK connector. Approximate priming volume: 1.4 mL Approximate length: 7 in. (17.7 in.)

456526

50

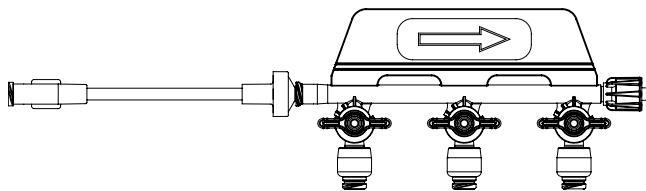

Triple swabbable port SAFEPORT with in-line backcheck valve and SPIN-LOCK connector. Approximate priming volume: 1.9 mL Approximate length: 8 in. (20.3 in.)

456521

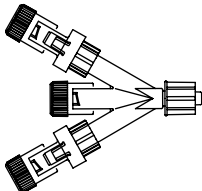

50

ANESTHESIA IV PRODUCTS

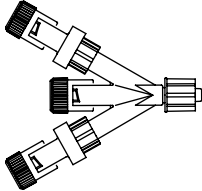
Description	Product Code	REF Number	Unit Per cs
Anesthesia Accessories			
 <p>Tri-Connector with SAFSITE® Valves – two SAFSITE valves on tri-connector with SPIN-LOCK connector. Priming volume: 1.2 mL.</p>	AET300	472025	50

 <p>Tri-Connector with Normally Closed Valves – two normally closed valves* on tri-connector with SPIN-LOCK connector. Priming volume: 1.2 mL.</p>	AET200	472026	50
---	--------	--------	----

Anesthesia Disinfection Workstation*



 <p>DOCit™ IPA Device for male luers</p>		418056	100 trays
 <p>HubScrub™ IPA Device for female luers</p>		418057	2,000 pc.
 <p>Anesthesia Disinfection Workstation</p>		456102	1 pc.

* Manufactured by SAXA Medical. B. Braun is a distributor of the Anesthesia Disinfection Workstation, DOCit and HubScrub. DOCit™ and HubScrub™ are trademarks of SAXA Medical Solutions LLC.

Description	REF Number	Unit Per cs
<p>ULTRAPORT™ Luer-Activated Needleless Stopcock Extension Sets</p> <p>Components on this page are not made with DEHP or natural rubber latex.</p>		
	456507	100
<p>High-Flow, four-way stopcock with luer-activated ULTRAPORT port and female luer lock port, 8 in. extension tubing and SPIN-LOCK® connector. Priming volume: 1.5 mL. Length: 10 in. (25 cm) (20.3 cm)</p>		
	456503	50
<p>High-Flow, four-way stopcock with luer-activated ULTRAPORT port and female luer lock port, 20 in. (50.8 cm) extension tubing, removable 6 in. (15.2 cm) extension tubing with luer lock connection, slide clamp and SPIN-LOCK connector. Priming volume: 4.56 mL. Length: 29 in. (73.7 cm)</p>		
<p>Same as above, except 35 in. (88.9 cm) extension tubing. Priming volume: 6.45 mL. Length: 43 in. (109.2 cm)</p>	456508	50
<p>Same as 456503 except with ULTRAPORT zero high-flow, four-way stopcock</p>	457503	50
	456505	100
<p>High-Flow, four-way stopcock with luer-activated ULTRAPORT port and female luer lock port, 26 in. (66 cm) extension tubing, ULTRASITE® injection site, removable 6 in. (15.2 cm) extension tubing with luer lock connection, slide clamp and SPIN-LOCK connector. Priming volume: 6.25 mL. Length: 42 in. (107 cm)</p>		
<p>Same as 456505 except with ULTRAPORT zero high-flow, four-way stopcock</p>	457505	100
	354222	100
<p>High-Flow, four-way stopcock with luer-activated ULTRAPORT port and female luer lock port, 26 in. (66 cm) extension tubing, CARESITE® injection site, removable 6 in. (15.2 cm) extension tubing with luer lock connection, slide clamp and SPIN-LOCK connector. Priming volume: 6.25 mL. Length: 42 in. (107 cm)</p>		

* For injection only

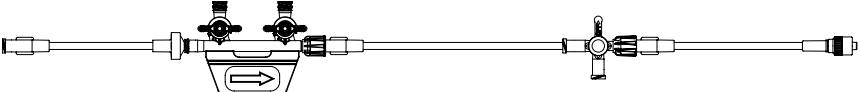
ANESTHESIA IV PRODUCTS

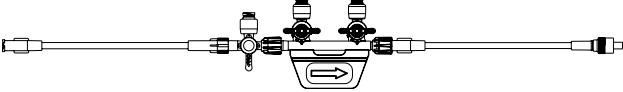
Description	REF Number	Unit Per cs
Open Lumen SAFEPORT™ Manifold Extension Sets Components on this page are not made with DEHP or natural rubber latex.		
	472036	50
Dual port SAFEPORT extension set with high-flow, four-way stopcock, and SPIN-LOCK® connector. Approximate priming volume: 6.3 mL Approximate length 39 in. (99.1 cm)		
	472038	50
Dual port SAFEPORT extension set with in-line backcheck valve, high-flow, four-way stopcock, and SPIN-LOCK connector. Approximate priming volume: 7.0 mL Approximate length 41 in. (104.1 cm)		
	456524	50
Dual port SAFEPORT extension set with ULTRAPORT high-flow, four-way stopcock and SPIN-LOCK connector. Priming volume: 8.1 mL. Length: 36 in. (142.2 cm)		
	457511	50
Dual port SAFEPORT® extension set with ULTRAPORT® zero high-flow, four-way stopcock and SPIN-LOCK connector. Priming volume: 8.1 mL. Length: 36 in. (142.2 cm)		

Description	Product Code	REF Number	Unit Per cs
-------------	--------------	------------	-------------

Stopcock Extension Sets

Components on this page are not made with DEHP or natural rubber latex.

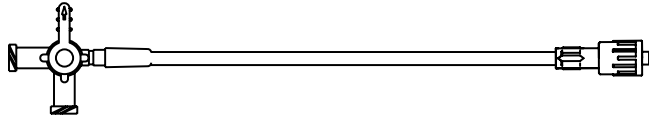

Four-way, two female luer lock ports, 9 in. (22.7 cm) extension tubing with SPIN-LOCK® connector, port covers. Priming volume: 1.4 mL. Length: 14 in. (36 cm)	HP509L	454320	100
---	--------	--------	-----

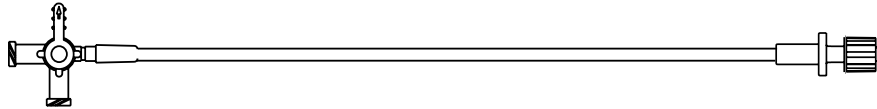

Four-way, two female luer lock ports, 20 in. (50.8 cm) extension tubing with SPIN-LOCK connector, port covers. Priming volume: 1.8 mL. Length: 22 in. (55.9 cm)	D520	456025	50
Same as above, except 33 in. (83.8 cm) extension tubing. Priming volume: 5.5 mL. Length: 35 in. (88.9 cm)	D533	456030	50

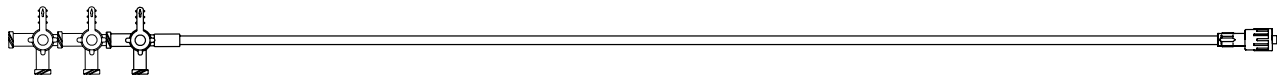

Three four-way, four female luer lock ports, 40 in. (101.6 cm) extension tubing with SPIN-LOCK connector, port covers. Priming volume: 6 mL. Length: 47 in. (119 cm)	ET123	473054	100
--	-------	--------	-----

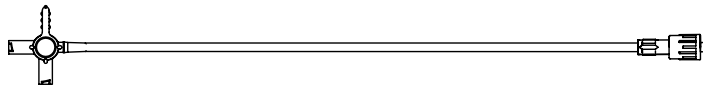

High-flow, four-way, two female luer lock ports, 20 in. (50.8 cm) extension tubing with SPIN-LOCK connector, port covers. Priming Volume: 3.5 mL. Length: 22 in. (56 cm)	D620	473541	50
Same as above, except 33 in. (83.8 cm) extension tubing. Priming volume: 5.9 mL. Length: 37 in. (94 cm)	D633	473543	50



Anesthesia IV Administration Sets

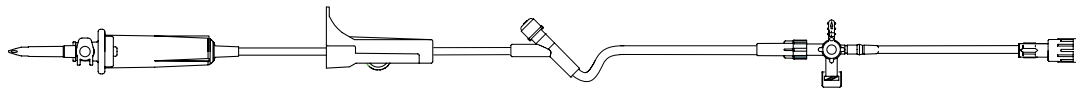

Components on this page do not contain DEHP or natural rubber latex.

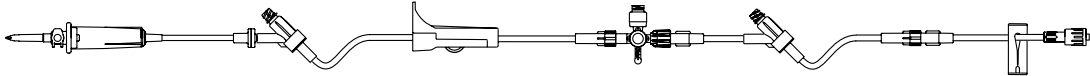
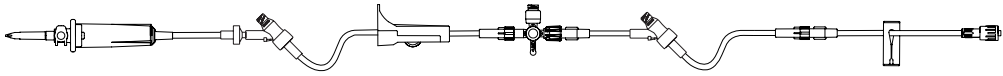
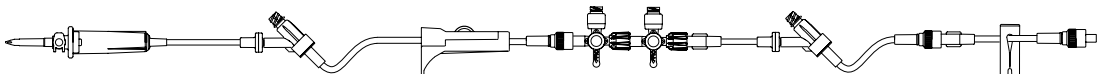
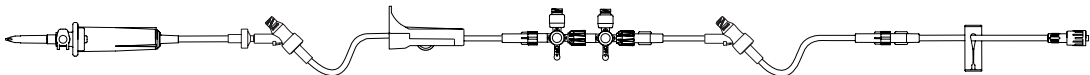

(15 drops/mL)— Universal spike, roller clamp, Injection site, luer lock connection, detachable four-way stopcock with 40 in. extension tubing, distal SPIN-LOCK® connector. Priming volume: 19.0 mL. Length: 111 in. (282 cm)	AD150DS	351510	50
---	---------	--------	----

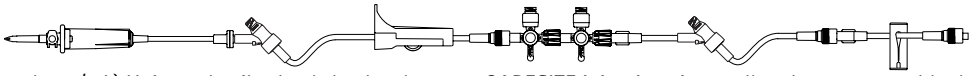
ANESTHESIA IV PRODUCTS

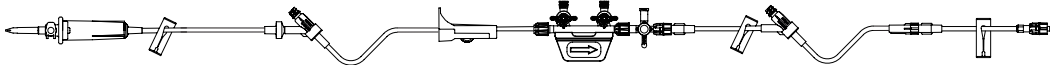
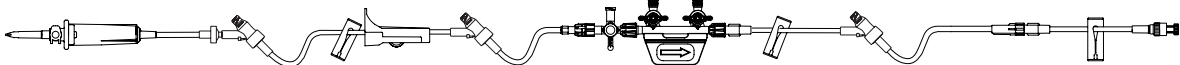
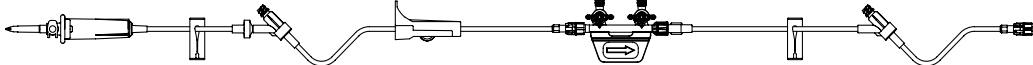
Description	REF Number	Unit Per cs
<p>ULTRAPORT™ Needleless Stopcock Anesthesia Sets Components on this page are not made with DEHP or natural rubber latex.</p>  <p>Universal spike (15 drops/mL), backcheck valve, two ULTRASITE® injection sites, roller clamp, removable high-flow, four-way stopcock with luer-activated ULTRAPORT port, female luer lock port, and SPIN-LOCK connector, removable 6 in. (15.2 cm) extension tubing with luer lock connection, slide clamp and SPIN-LOCK connector. Priming volume: 23 mL. Length: 131 in. (333 cm)</p>	456506	50
 <p>Universal spike (15 drops/mL), backcheck valve, two CARESITE® injection sites, roller clamp, removable high-flow, four-way stopcock with luer-activated ULTRAPORT port, female luer lock port, and SPIN-LOCK connector, removable 6 in. (15.2 cm) extension tubing with luer lock connection, slide clamp and SPIN-LOCK connector. Priming volume: 23 mL. Length: 131 in. (333 cm)</p>	354209	50
 <p>Universal spike (15 drops/mL), backcheck valve, two ULTRASITE injection sites, roller clamp, two removable high-flow, four-way stopcocks with luer-activated ULTRAPORT port, female luer lock port, and SPIN-LOCK connector, removable 6 in. (15.2 cm) extension tubing with luer lock connection, slide clamp and SPIN-LOCK connector. Priming volume: 24 mL. Length: 130 in. (330 cm)</p>	456504	50
 <p>Universal spike (15 drops/mL), backcheck valve, two CARESITE injection sites, roller clamp, two removable high-flow, four-way stopcocks with luer-activated ULTRAPORT port, female luer lock port, and SPIN-LOCK connector, removable 6 in. (15.2 cm) extension tubing with luer lock connection, slide clamp and SPIN-LOCK connector. Priming volume: 24 mL. Length: 130 in. (330 cm)</p>	354210	50
 <p>(15 drops/mL) Universal spike, backcheck valve, two CARESITE injection sites, roller clamp, removable ULTRAPORT zero high-flow, 4-way stopcock, slide clamp, SPIN-LOCK connector. Priming volume 22.9 mL. Overall Length 131 in. (331 cm)</p>	457506	50
 <p>(15 drops/mL) Universal spike, backcheck valve, two CARESITE injection sites, roller clamp, removable dual ULTRAPORT zero high-flow, 4-way stopcocks, slide clamp, SPIN-LOCK connector. Priming volume 22.8 mL. Overall Length 130 in. (329 cm)</p>	457504	50

Description	Product Code	REF Number	Unit Per cs
<p>Open Lumen SAFEPORT™ Manifold Sets</p> <p>Components on this page are not made with DEHP or natural rubber latex.</p> 	352393	352393	50
<p>(15 drops/mL) Universal spike, backcheck valve, two ULTRASITE injection sites, three slide clamps, roller clamp, dual port SAFEPORT, SPIN-LOCK connector, removable 6 in. extension tubing. Priming volume: 23 mL Approximate length 129 in. (327.7 cm)</p>			
	354211	354211	50
<p>(15 drops/mL) Universal spike, backcheck valve, three CARESITE® injection sites, three slide clamps, roller clamp, high-flow, four-way stopcock and dual port SAFEPORT, SPIN-LOCK connector, removable 6 in. extension tubing. Priming Volume: 24 mL, Length: 137 in. (348 cm)</p>			
	352415	352415	50
<p>(15 drops/mL) Universal spike, backcheck valve, two ULTRASITE® injection sites, two slide clamps, roller clamp, dual port SAFEPORT, SPIN-LOCK connector, Priming Volume: 22 mL, Length: 123 in (312.4 cm)</p>			
	354208	354208	50
<p>(15 drops/mL) Universal spike, backcheck valve, two CARESITE injection sites, three slide clamps, roller clamp, dual port SAFEPORT, SPIN-LOCK male connector, removable 6 in. extension tubing. Priming Volume: 23 mL, Length: 131 in. (332.9 cm)</p>			
	NF1270A	NF1270A	50
<p>(15 drops/mL), Universal spike, backcheck valve, three SafeLine® injection sites, two slide clamps, roller clamp, removable high-flow, four-way stopcock and dual port SAFEPORT, SPIN-LOCK connector. removable 6 in. extension tubing. Priming Volume: 24 mL, Length: 134 in (340.4 cm)</p>			

ANESTHESIA IV PRODUCTS

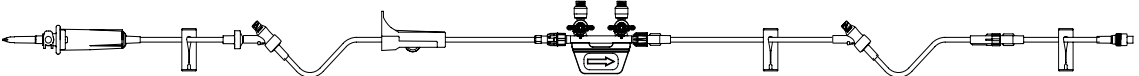
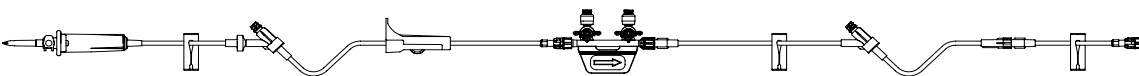
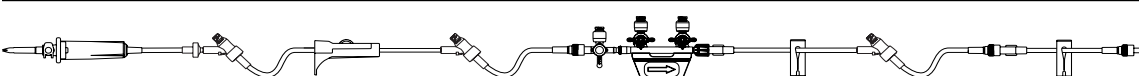
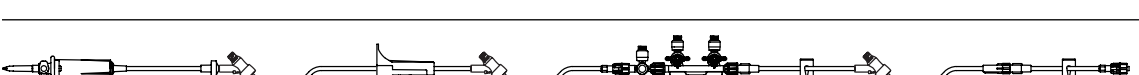
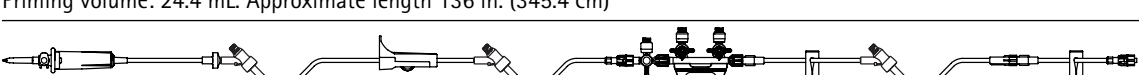
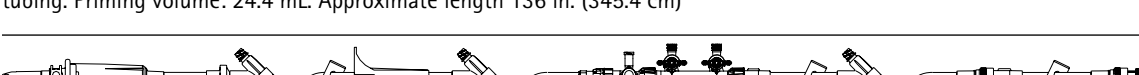
Description	Product Code	REF Number	Unit Per cs
 <p>(15 drops/mL) Universal spike, backcheck valve, two CARESITE® injection sites, three slide clamps, roller clamp, dual port SAFEPORT, SPIN-LOCK connector, removable 6 in. extension tubing. Priming volume: 21.8 mL. Approximate length 129 in. (326 cm)</p>		456512	50
 <p>(15 drops/mL) Universal spike, backcheck valve, two ULTRASITE® injection sites, three slide clamps, roller clamp, dual port SAFEPORT, SPIN-LOCK connector, removable 6 in. extension tubing. Priming volume: 21.8 mL. Approximate length 129 in. (326 cm)</p>		456523	50
 <p>(15 drops/mL) Universal spike, backcheck valve, three CARESITE injection sites, two slide clamps, roller clamp, removable ULTRAPORT high-flow, four-way stopcock, dual port SAFEPORT, SPIN-LOCK connector, removable 6 in. extension tubing. Priming volume: 24.4 mL. Approximate length 136 in. (345.4 cm)</p>		457509	50
 <p>(15 drops/mL) Universal spike, backcheck valve, three ULTRASITE injection sites, two slide clamps, roller clamp, removable ULTRAPORT high-flow, four-way stopcock, dual port SAFEPORT, SPIN-LOCK connector, removable 6 in. extension tubing. Priming volume: 24.4 mL. Approximate length 136 in. (345.4 cm)</p>		456525	50
 <p>(15 drops/mL) Universal spike, backcheck valve, three CARESITE injection sites, two slide clamps, roller clamp, removable ULTRAPORT zero high-flow, four-way stopcock, dual port SAFEPORT, SPIN-LOCK connector, removable 6 in. extension tubing. Priming volume: 24.4 mL. Approximate length 136 in. (345.4 cm)</p>		457515	50
 <p>(15 drops/mL) Universal spike, backcheck valve, three ULTRASITE injection sites, three slide clamps, roller clamp, high-flow, four-way stopcock and dual port SAFEPORT, SPIN-LOCK connector, removable 6 in. extension tubing. Priming Volume: 24 mL, Length: 137 in. (348 cm)</p>		US1275A	50

Description	Product Code	REF Number	Unit Per cs
-------------	--------------	------------	-------------

Basic IV Administration Sets

Components on this page are not made with DEHP or natural rubber latex.

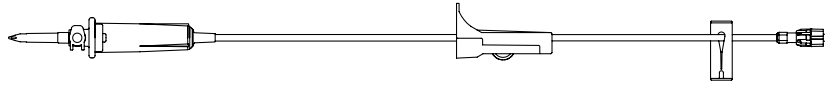

(15 drops/mL) Universal spike, roller clamp, slide clamp, and SPIN-LOCK® connector. Priming Volume: 13 mL, Length: 85 in. (215.9 cm). Labeled "Contents Sterile".

V1501	352601	50
-------	--------	----

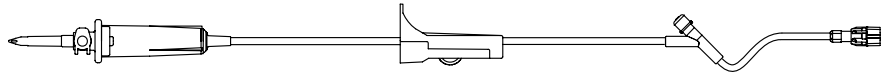

(15 drops/mL) Universal spike, roller clamp, slide clamp, injection site 26 inches above distal end, SPIN-LOCK connector. Priming Volume: 19 mL, Length: 93 in. (236.2 cm)

V1415-15	V1415-15	50
----------	----------	----

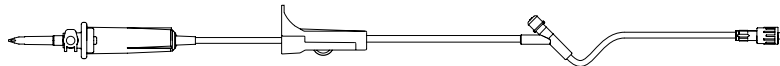

(15 drops/mL) Universal spike, roller clamp, injection site 6 inches above distal end, SPIN-LOCK connector. Priming Volume: 15 mL, Length: 81 in. (205.7 cm)

V1390	V1390	50
-------	-------	----

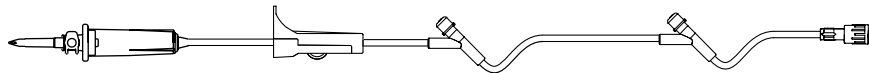

(15 drops/mL) Universal spike, roller clamp, injection sites 28 inches and 6 inches above distal end, SPIN-LOCK connector. Priming Volume: 18 mL, Length: 84 in. (213.4 cm)

V1421-20	V1421-20	50
----------	----------	----

Mini-Drop Basic Administration Set

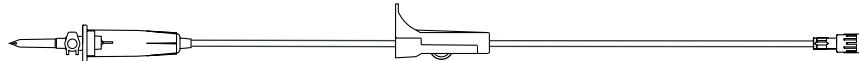

(60 drops/mL) Universal spike, roller clamp, SPIN-LOCK connector. Priming Volume: 13 mL, Length: 67 in. (170.2 cm)

V1425-15	V1425-15	50
----------	----------	----

Secondary Administration Set for Use with ADDitIV® Primary Administration Sets



(15 drops/mL) Universal spike, roller clamp, SPIN-LOCK connector, with 10.5" plastic bag hanger. Priming Volume: 8.8 mL, Length: 40 in. (101.6 cm).

V1921	V1921	50
-------	-------	----

Basic Y-Type Administration Set



(15 drops/mL) 2 Universal spikes, two roller clamps, roller clamp, injection site, SPIN-LOCK connector. Priming Volume: 25 mL, Length: 86 in. (218 cm)

V1500	V1500	50
-------	-------	----

IV Administration Sets

IV ADMINISTRATION SETS

Description	Product Code	REF Number	Unit Per cs
-------------	--------------	------------	-------------

ADDitIV® Primary Filtered Administration Set with Backcheck Valve and 0.2 micron Filter

Components on this page are not made with DEHP or natural rubber latex.

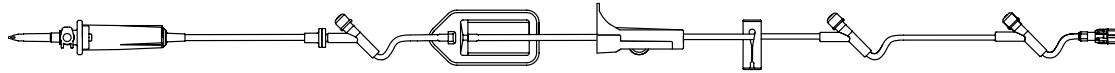

(15 drops/mL) Universal spike, backcheck valve, 0.2 micron filter, 3 injection sites, roller clamp, slide clamp, SPIN-LOCK® connector. Priming Volume: 20 mL, Length: 83 in. (211 cm).

V1782F

352447

50

Filterflow® Primary Filtered IV Administration Set with 1.2 micron Filter

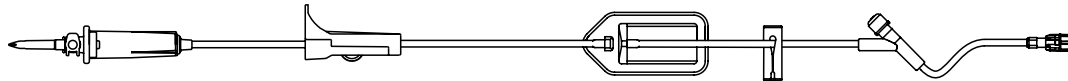

(15 drops/mL) Vista® Dual Application Gravity and Pump Set - Universal spike, slide clamp, roller clamp, 1.2 micron filter, slide clamp, 1 injection site and SPIN-LOCK connector. Priming Volume: 19 mL, Length: 106 in. (269 cm).

V8812F

352401

50

Filterflow® Filtered Administration Set with 0.2 micron Filter

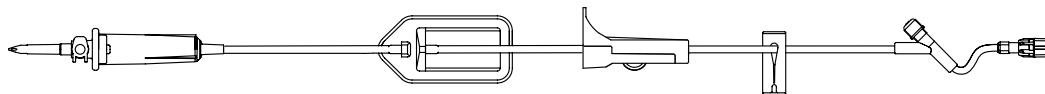

(15 drops/mL) Universal spike, 0.2 micron filter, roller clamp, slide clamp, 1 injection site and SPIN-LOCK connector. Priming Volume: 21 mL, Length: 89 in. (226 cm).

V1792F

352424

50

Description	Product Code	REF Number	Unit Per cs
-------------	--------------	------------	-------------

PERIPHERAL EXTENSION SETS

Standard Bore Extension Sets

Components on this page are not made with DEHP or natural rubber latex.

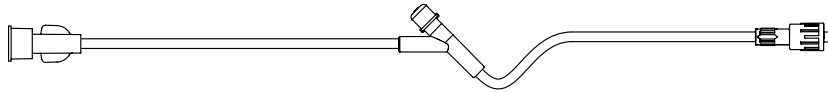

Female luer connector, injection site 4 inches above distal end, distal SPIN-LOCK® connector. Priming volume: 1.18 mL. Length: 7.5 in. (19 cm)

V5402	V5402	50
-------	-------	----

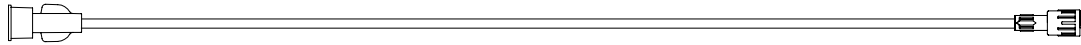

Female luer connector, distal SPIN-LOCK connector. Priming volume: 3 mL. Length 21 in. (52.5 cm)

V5406	V5406	50
-------	-------	----

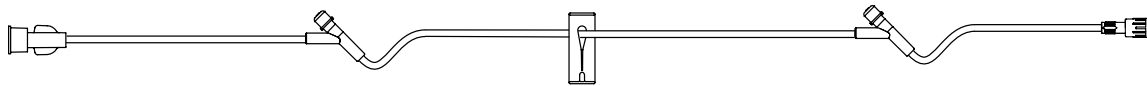

Female luer connector, injection sites 24 and 6 inches above distal end, slide clamp, distal SPIN-LOCK connector. Priming volume: 5 mL. Length: 34 in. (86.2 cm)

V5409	V5409	50
-------	-------	----

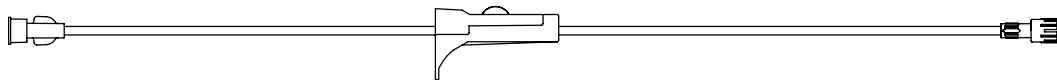

Female luer connector, large bore tubing, roller clamp, distal SPIN-LOCK connector. Priming volume: 4.3 mL. Length: 31 in. (78.5 cm)

V5484	V5484	50
-------	-------	----

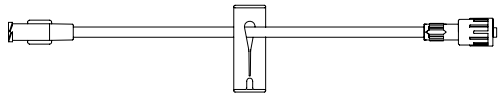

Female luer connector, slide clamp, distal SPIN-LOCK connector. Priming volume: 1 mL. Length: 7 in. (18 cm)

ET06L	471975	100
-------	--------	-----

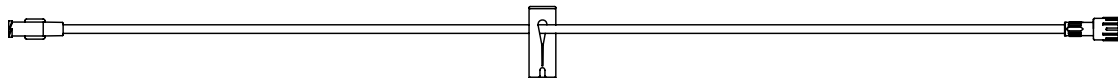

Female luer connector, slide clamp, distal SPIN-LOCK connector. Priming volume: 4.3 mL. Length: 30 in. (76 cm)

ET30LC	473012	100
--------	--------	-----

Standard Bore T-Port Extension Sets

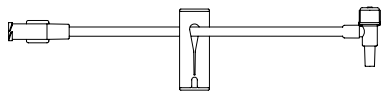

Female luer connector, slide clamp, distal T-port with male luer slip connector. Priming volume: 0.6 mL. Length: 6 in. (15 cm)

ET04TR	471949	100
--------	--------	-----

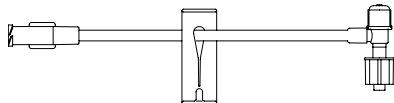

Female luer connector, slide clamp, distal T-port with SPIN-LOCK® connector. Priming volume: 0.6 mL. Length: 6 in. (15 cm)

ET04TSR	471953	100
---------	--------	-----

IV ADMINISTRATION SETS

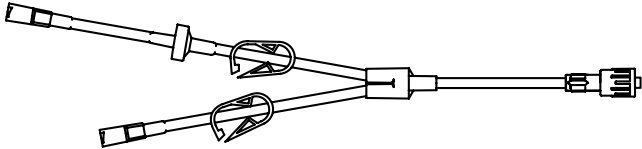
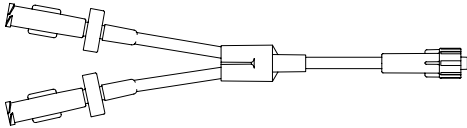
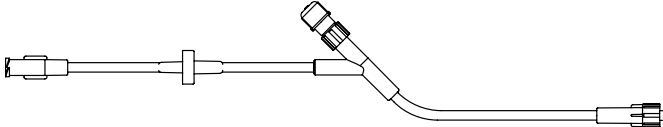
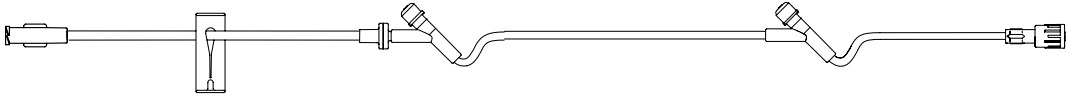
Description	Product Code	REF Number	Unit Per cs
PERIPHERAL EXTENSION SETS			
Backcheck Valve Extension Sets			
	ET08YL	471980	50
<p>Y-type with 2 female luer lock connectors, backcheck valve, 2 on/off clamps, distal SPIN-LOCK® connector. Components are not made with DEHP or natural rubber latex. Priming volume: 1.8 mL. Length: 10 in. (25 cm)</p>			
	ET06YL	471979	100
<p>Y-type with 2 proximal female luer lock connectors, 2 dual backcheck valves. distal male luer lock connector. Components are not made with natural rubber latex. Priming volume: 1.5 mL. Length: 6 in. (15 cm)</p>			
	ET107	473007	100
<p>Female luer connector, backcheck valve above injection site, with IN4000 injection cap attached, distal male luer lock connector. Components are not made with natural rubber latex. Priming volume: 2 mL. Length 8 in. (20 cm)</p>			
	V5405	V5405	50
<p>Female luer connector, slide clamp, backcheck valve, injection sites 18 and 16 inches above distal end, male luer lock connector. Components are not made with DEHP or natural rubber latex. Priming volume: 6 mL. Length 34 in. (86.4 cm).</p>			

Description	Product Code	REF Number	Unit Per cs
-------------	--------------	------------	-------------

PERIPHERAL EXTENSION SETS

Small Bore Extension Sets

Components on this page are not made with natural rubber latex.

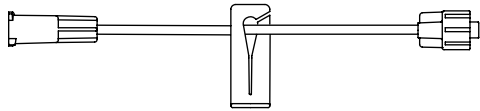

Female luer connector, removable slide clamp, distal male luer lock connector. Priming volume: 0.2 mL. Length: 6 in. (15.2 cm) ET06S 471960 100

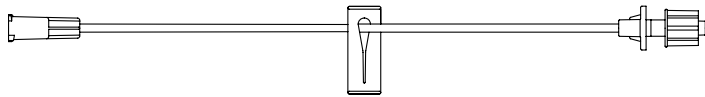

Female luer connector, non-removable slide clamp, distal SPIN-LOCK® connector. Priming volume: 0.44 mL. Length 13 in. (31.0 cm) ET12SB 473105 100

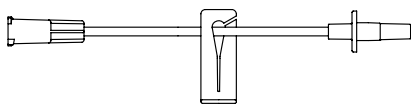

Female luer connector, removable slide clamp, distal male luer slip connector. Priming volume: 0.2 mL. Length: 6 in. (15.2 cm) ET06LS 471991 100

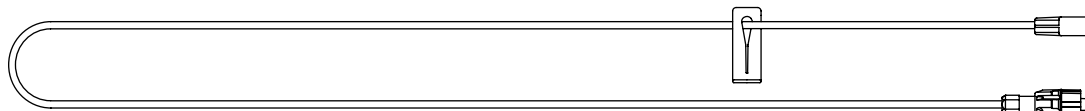

Female luer connector, slide clamp, distal male SPIN-LOCK connector. Priming volume: 2 mL. Length: 61 in. (155 cm) ET112 471973 100

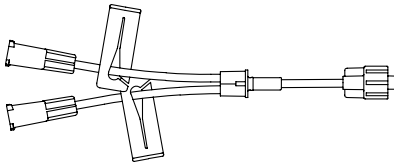

Y-type with 2 female luer connectors, 2 removable slide clamps, distal male luer lock connector. Priming volume: 0.46 mL. Length: 6 in. (15 cm) ET06MDA 471957 100

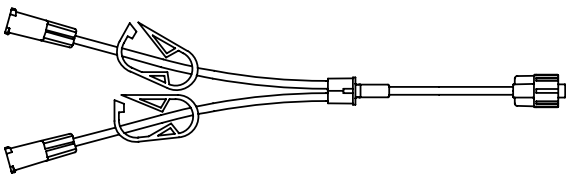

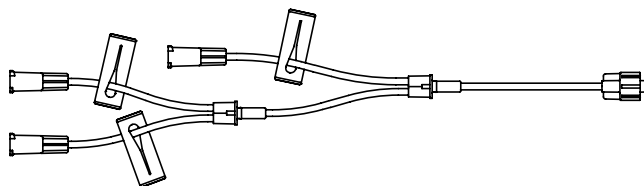

Y-type with 2 female luer lock connectors, 2 on/off clamps and distal male luer lock connector. Priming volume: 0.5 mL. Length: 8 in. (20 cm) ET103 471959 100

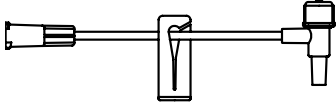
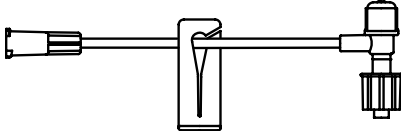

Triple-leg set with 3 female luer connectors, 3 non-removable slide clamps, distal male luer lock connector. Priming volume: 0.5 mL. Length: 9 in. (23 cm) ET110 473041 100

IV ADMINISTRATION SETS

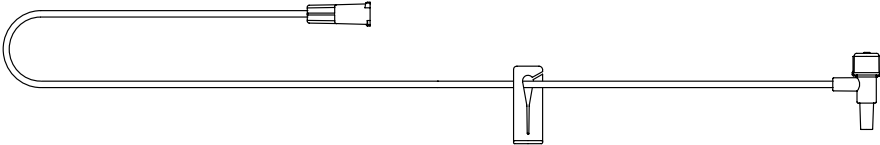
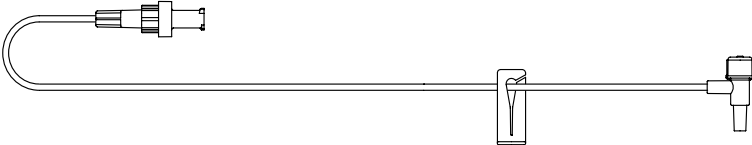
Description	Product Code	REF Number	Unit Per cs
PERIPHERAL EXTENSION SETS			
Small Bore T-Port Extension Sets			
	ET04T	471950	100
<p>Female luer lock connector, removable slide clamp, distal T-port with male luer slip connector. Components are not made with DEHP or natural rubber latex. Priming volume: 0.25 mL. Length: 4.75 in. (12 cm)</p>			
	ET04TS	471954	100
<p>Female luer lock connector, removable slide clamp, distal T-port with SPIN-LOCK® connector. Components are not made with DEHP or natural rubber latex. Priming volume: 0.1 mL. Length: 4 in. (10.2 cm)</p>			
	ET06THR	471962	100
<p>Female luer lock connector, on/off clamp, distal T-port with male luer slip connector. Components are not made with DEHP or natural rubber latex. Priming volume: 0.3 mL. Length: 7 in. (18 cm)</p>			
	ET38T	473022	100
<p>Female luer lock connector, removable slide clamp, distal T-port with male luer slip connector. Components are not made with natural rubber latex. Priming volume: 1.2 mL. Length: 38 in. (97 cm)</p>			
	ET30TCV	473009	100
<p>Female luer lock connector, normally closed backcheck valve, removable slide clamp, distal T-port with male luer slip connector. Components are not made with natural rubber latex. Priming volume: 1.1 mL. Length: 30 in. (76 cm)</p>			

Description	Product Code	REF Number	Unit Per cs
-------------	--------------	------------	-------------

Syringe Pump PVC-free Fluid Path Microbore Extension Sets

Components on this page are not made with natural rubber latex.



Female luer and distal male luer lock. Microbore extension set, 0.02 in. ID. tubing with fluid path that does not contain PVC. Priming volume: 0.3 mL, Length: 36 in. (91 cm)

V6220

V6220

50



Female luer and distal male luer lock. Microbore extension set, 0.03 in. ID. tubing with fluid path that does not contain PVC. Use with higher flow rates and viscous fluids. Priming volume: 0.6 mL, Length: 36 in. (91 cm)

V6203

V6203

50

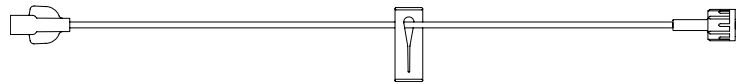

Female luer and distal male luer lock. Microbore extension set, 0.02 in. ID. tubing with fluid path that does not contain PVC. Priming volume: 0.5 mL, Length: 60 in. (152 cm)

V6222

V6222

50

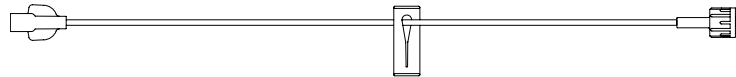

Female luer and distal male luer lock. Microbore extension set, 0.03 in. ID. with fluid path that does not contain PVC. Use with higher flow rates and viscous fluids. Priming volume: 0.8 mL, Length: 60 in. (152 cm)

V6223

V6223

50



Female luer and distal male luer lock. Microbore extension set, 0.2 micron filter., 0.03 in. ID. tubing with fluid path that does not contain PVC. Priming volume: 1.3 mL, Length: 60 in. (152 cm)

V6215

V6215

50

Syringe Pump Microbore Extension Sets with Proximal and Distal Male Luer Locks

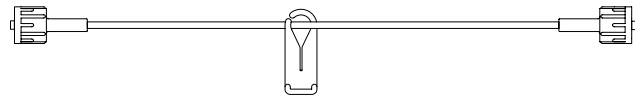

Proximal and distal male luer locks. Microbore extension set, 0.04 in. ID., removable slide clamp. Priming volume: 0.6 mL, Length: 31 in. (79 cm)

V5450

V5450

50

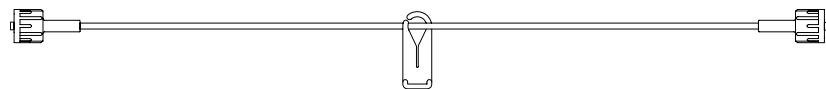

Proximal and distal male luer locks. Microbore extension set, 0.04 in. ID., removable slide clamp. Priming volume: 1.2 mL, Length: 63 in. (160 cm)

V5456

V5456

50

Microbore Extension Set

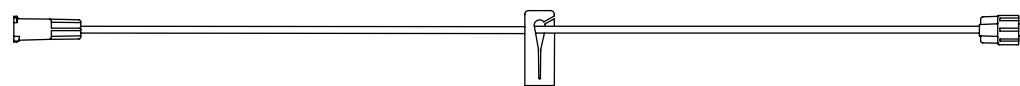

Female luer connector, removable slide clamp, male luer lock connector. Priming volume: 0.6 mL, Length 19 in. (48 cm)

V5424

V5424

50

IV ADMINISTRATION SETS

Description	Product Code	REF Number	Unit Per cs
-------------	--------------	------------	-------------

Filterflow® Small Bore FILTERED EXTENSION SETS

with 0.2 micron low volume filter

Components on this page are not made with DEHP or natural rubber latex.

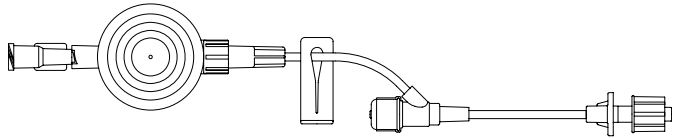

Female luer connector, 0.2 micron low volume SUPOR® filter, slide clamp, injection site 3 inches above distal end, SPIN-LOCK® connector. Priming Volume: 1.2 mL, Length: 8 in. (20 cm).	PFE2007	352205	50
---	---------	--------	----

with 0.2 micron micro volume filter

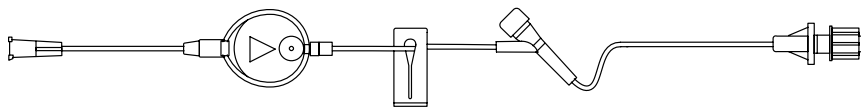

Female luer connector, 0.2 micron micro volume SUPOR filter, slide clamp, injection site 3 inches above distal end, SPIN-LOCK connector. Priming Volume: 0.7 mL, Length: 7 in. (18 cm).	MFE2007	473061	50
---	---------	--------	----

with 1.2 micron low volume air-eliminating filter

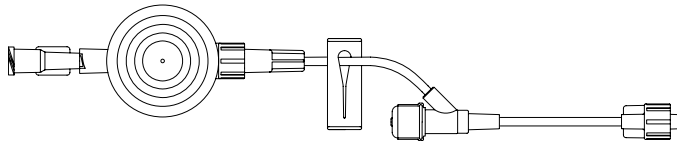

1.2 micron SUPOR low-volume air-eliminating in-line filter with slide clamp, small bore tubing, injection site and luer lock connection. Priming Volume: 0.9 mL, Length: 8 in. (20 cm).	PFE1207	352212	50
---	---------	--------	----

0.2 micron low volume add-on filter

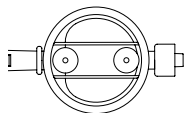

0.2 micron SUPOR Low Volume air-eliminating IV filter with female luer lock and SPIN-LOCK connectors. Priming Volume: 0.8 mL.	PFE2000	473036	50
---	---------	--------	----

SUPOR is a registered trademark of the Pall Corporation

Description	Product Code	REF Number	Unit Per cs
-------------	--------------	------------	-------------

FILTERED EXTENSION SETS

with 0.2 micron air-eliminating filter

Components on this page are not made with DEHP or natural rubber latex.

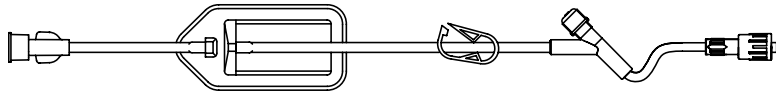

Female luer connector, 0.2 micron filter, 1 injection site, on/off clamp and SPIN-LOCK® connector. Priming Volume: 5.1 mL, Length: 16 in. (40.6 cm).	FE2012F	473989	50
--	---------	--------	----

with 1.2 micron air-eliminating filter

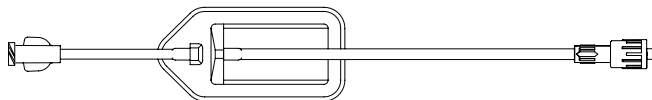

1.2 micron air-eliminating filter with luer lock connector. Priming Volume: 4.3 mL, Length: 10 in. (25 cm)	FE1209F	473994	50
--	---------	--------	----

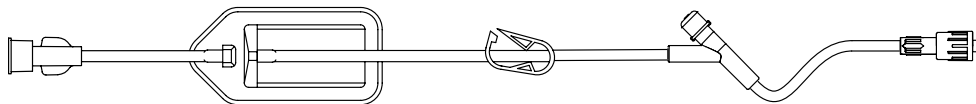

1.2 micron air-eliminating filter with 1 injection site and SPIN-LOCK connector. Priming Volume: 5.1 mL, Length: 16 in. (40.6 cm)	FE1212F	473995	50
---	---------	--------	----

with 5.0 micron air-eliminating filter

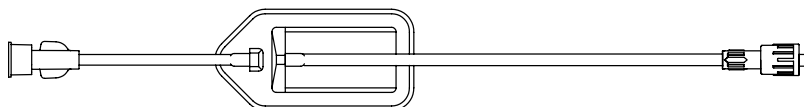

5.0 micron air-eliminating in-line filter with female luer connector, male SPIN-LOCK connector. Priming volume: 3.6 mL. Length: 10 in. (25.4 cm).	FE5009F	474002	50
---	---------	--------	----

SUPOR is a registered trademark of the Pall Corporation

IV ADMINISTRATION SETS

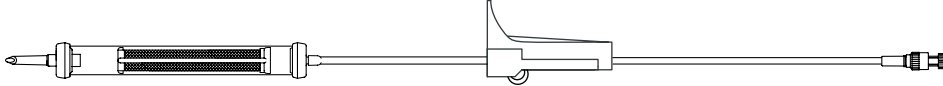
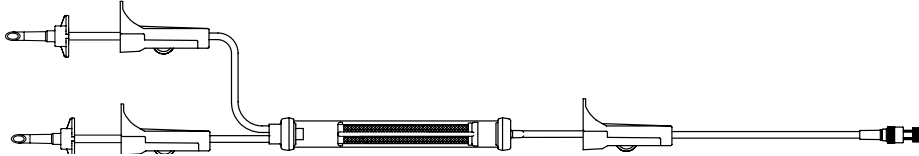
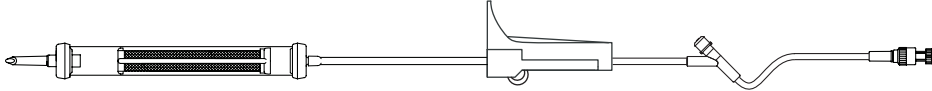
Description	Product Code	REF Number	Unit Per cs
BLOOD ADMINISTRATION SETS			
Components on this page are not made with natural rubber latex.			
			
(10 drops/mL) Drip chamber with 170 micron blood filter, roller clamp, SPIN-LOCK® connector. Priming volume: 31 mL, Length: 76 in. (193 cm)	V2400	V2400	50
			
(10 drops/mL) Y-Type, three roller clamps, drip chamber with 170 micron blood filter, SPIN-LOCK connector. Priming volume: 34 mL, Length: 87 in. (221 cm)	V2500	V2500	50
			
(10 drops/mL) Drip chamber with 170 micron blood filter, roller clamp, injection site 6 inches above the distal end, SPIN-LOCK connector. Priming volume: 30 mL, Length: 75 in. (191 cm)	V2410	V2410	50

Blood Administration Sets with Hand Pump

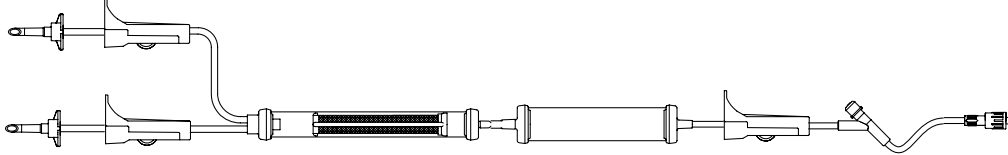
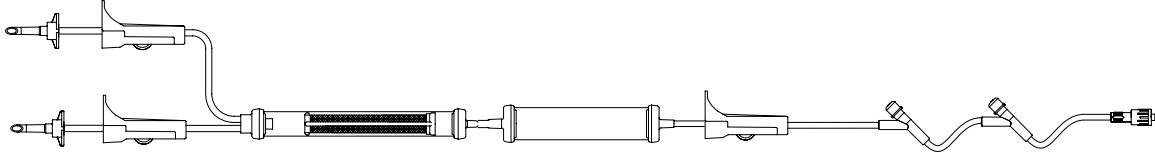
			
(10 drops/mL) Y-Type, three roller clamps, drip chamber with 170 micron blood filter, pump chamber, injection site 6 inches above distal end, SPIN-LOCK connector. Priming volume: 69 mL. Length: 85 in. (216 cm)	V2560	V2560	50
Same as V2560, except 148 in. (376 cm) in length. Priming volume: 80 mL.	V2560-39	V2560-39	50
			
(10 drops/mL) Y-Type, three roller clamps, drip chamber with 170 micron blood filter, pump chamber, injection sites 6 and 41 inches above distal end, SPIN-LOCK connector. Priming volume: 71 mL. Length: 98 in. (249 cm)	V2560-37	V2560-37	50

Description	Product Code	REF Number	Unit Per cs
-------------	--------------	------------	-------------

BLOOD ADMINISTRATION ACCESSORIES

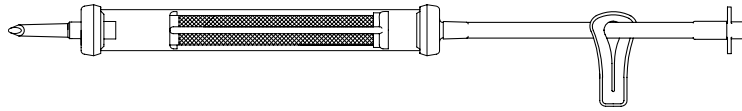

(10 drops/mL) Drip chamber with 170 micron blood filter, slide clamp, spike adapter. Components are not made with natural rubber latex. Priming volume: 19 mL. Length: 9 in. (23 cm)

V2950	V2950	50
-------	-------	----

Plasma Transfer Administration Set

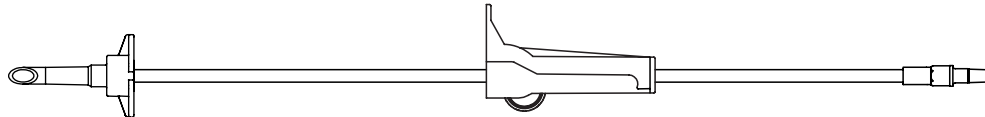

Non-vented spike, roller clamp, male luer slip connector. Priming volume: 16 mL Length: 27 in. (68.6 cm) Components are not made with DEHP or natural rubber latex.

V2203	V2203	50
-------	-------	----

MEASURED VOLUME SOLUTION BURETTE SETS

Mini-Drop Administration Set with Float Valve Automatic Shutoff

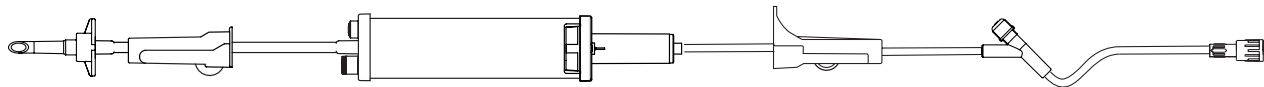

(60 drops/mL) Non-vented spike, roller clamp, 150 mL burette chamber, roller clamp, injection site 6 inches above distal end, SPIN-LOCK® connector. Components are not made with natural rubber latex. Priming Volume: 15 mL, Length: 87 in. (221.0 cm)

V1429M	375113	20
--------	--------	----

Add-On Set without Automatic Shutoff

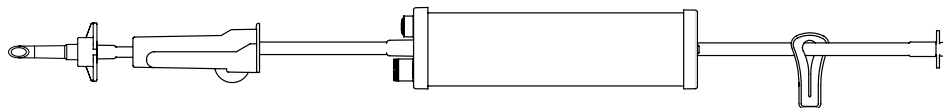

Non-vented spike, roller clamp, 150 mL burette chamber, slide clamp, spike adapter. Components are not made with natural rubber latex. Priming Volume: 3 mL, Length: 20 in. (51.0 cm)

V2905M	375112	20
--------	--------	----

IV ADMINISTRATION SETS

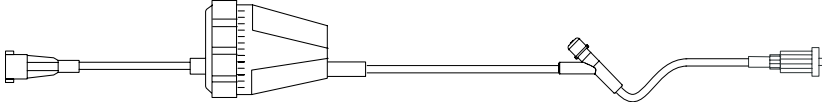
Description	Product Code	REF Number	Unit Per cs
RATE FLOW® REGULATOR ADMINISTRATION SETS			
Extension Set with Rate Flow Regulator			
Components on this page are not made with DEHP or natural rubber latex.			
	V5200	V5200	50

IV Administration Set with Rate Flow Regulator

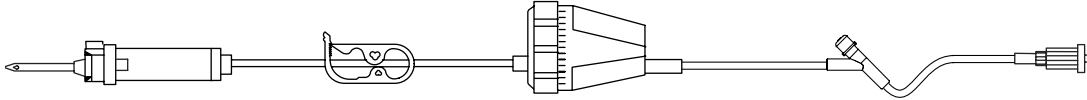
	V5922	V5922	50
--	-------	-------	----

Mini-Drop IV Administration Set with Rate Flow Regulator

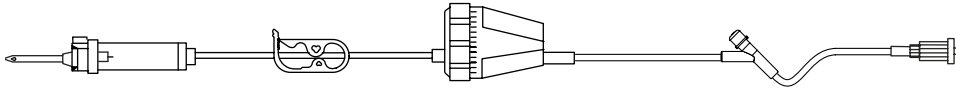
	V5926	V5926	50
--	-------	-------	----

ADDitIV® Primary Administration Set with Backcheck Valve and Rate Flow Regulator

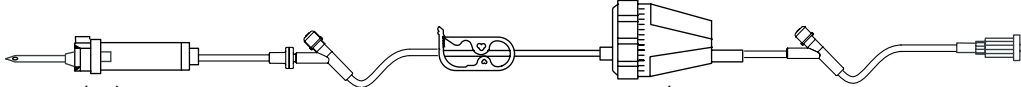
	V5932	V5932	50
--	-------	-------	----

Emergency Medical Services Set with Rate Flow Regulator

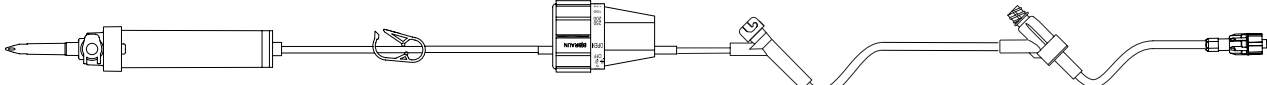
	USNF5932	375173	50
--	----------	--------	----

Description	Product Code	REF Number	Unit Per cs
-------------	--------------	------------	-------------

SPECIAL ACCESSORIES

Pressure Administration Cuff

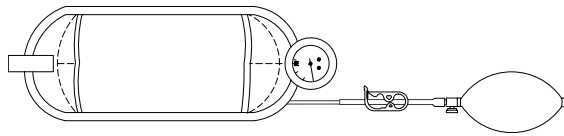

Pressure Administration Cuff for rapid administration of IV fluids from bags. Components are not made with natural rubber latex.	N5062	N5062	1
--	-------	-------	---

Warm Packs



T-Pak® I.V. Instant Warm Pack, for external application for vein dilation. Four 10-pack cartons.	N6115	N6115	40
--	-------	-------	----

Special Application Accessories

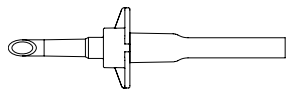

Spike Adapter. Components are not made with natural rubber latex.	N2050	N2050	24
---	-------	-------	----

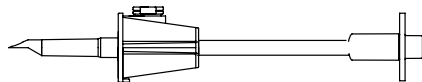

Vented Spike Adapter. Components are not made with natural rubber latex.	N2061	N2061	50
--	-------	-------	----

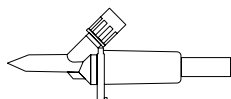

Vented Spike Adapter- permits connection of non-vented IV spike to IV bottle requiring a vent. Components are not made with natural rubber latex.	SA2000	418105	20
---	--------	--------	----





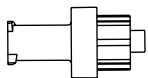

Dual Male Adapter -male luer lock connector and distal SPIN-LOCK® connector. Connects two female luer connections. Components are not made with DEHP or natural rubber latex. Priming volume: 0.1 mL	DMA1000	456080	100
--	---------	--------	-----



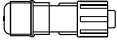
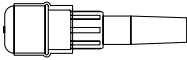

Normally Closed Check Valve/Antisiphon Valve - requires syringe pressure to open, luer lock. Components are not made with DEHP or natural rubber latex. Priming volume: 0.12 mL	BC1000	415062	100
---	--------	--------	-----

T-Pak is a registered trademark of CareFusion Corporation

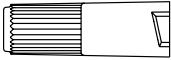
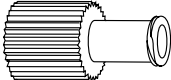
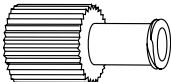
IV ADMINISTRATION SETS

Description	Product Code	REF Number	Unit Per cs
INJECTION CAPS			
	IN1000	654237	1000
Intermittent Injection Cap - opaque yellow body, proximal self-sealing injection port, distal male luer lock connector with recessed luer taper. Components are not made with DEHP or natural rubber latex. Priming volume: 0.16 mL. Length: 0.875 in. (2.2 cm)			
	IN2000	418020	100
Intermittent Injection Cap - proximal injection port, clear body, distal male luer lock connector. Components are not made with DEHP or natural rubber latex. Priming volume: 0.2 mL. Length: 1.125 in. (2.9 cm)			
	IN3000	418025	100
Intermittent Injection Cap - proximal injection port, distal luer slip connector. Components are not made with DEHP or natural rubber latex. Priming volume: 0.2 mL. Length: 1.125 in. (2.9 cm)			
	IN4000	418030	100
Intermittent Injection Cap - proximal injection port, distal male luer lock connector. Components are not made with DEHP or natural rubber latex. Priming volume: 0.1 mL. Length: 0.75 in. (1.9 cm)			
REPLACEMENT CAPS			
	B1000	418017	100
Blue Replacement Cap - male luer lock.			
Blue Replacement Cap - bulk pack of 1,000 in dispenser boxes of 100 each.	B1000B	418027	1000
White Replacement Cap - male luer lock.	C1000	418015	100
	BW1000	BW1000	100
Replacement Caps - blue male luer lock cap and white female luer lock cap.			
	W1000	474900	100
White Replacement Cap - female luer lock.			
	R2000B	R2000B	1000
RED CAP™ luer cap - Dual function red cap with male and female end. Bulk pack of 1,000 in dispenser			
	B2000B	B2000B	1000
Blue Cap luer cap - Dual function blue cap with male and female end. Bulk pack of 1,000 in dispenser boxes of 100 each.			

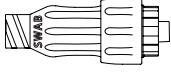
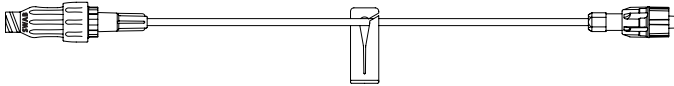
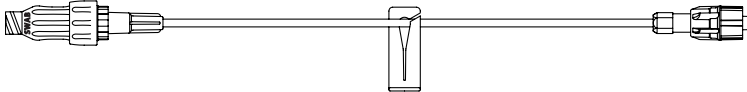
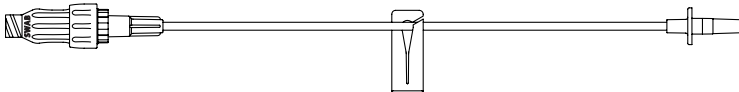
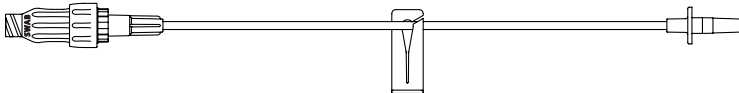
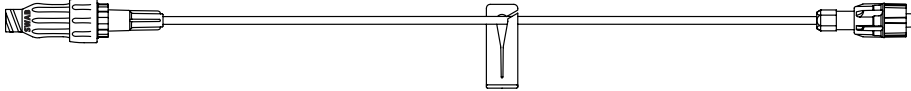
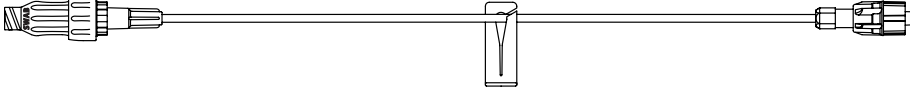
CARESITE® (LAD) System

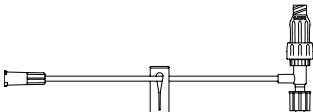
Description	Product Code	REF Number	Unit Per cs
 <p>CARESITE (LAD) CARESITE (LAD) valve for aspiration, injection or gravity flow of fluid upon insertion of a male luer fitting. Components are not made with DEHP or natural rubber latex. Priming volume: 0.22 mL. Power injection rated to 300 psi and 10 mL/sec</p>	415122	415122	200
<p>CARESITE Small Bore Extension Sets</p>			
 <p>For use with power injectors – maximum 300 psi and maximum flow rate 10 mL/sec Small bore extension set with bonded CARESITE (LAD) valve, removable slide clamp, SPIN-LOCK® connector. Components are not made with DEHP or natural rubber latex. Priming volume: 0.5 mL, Length: 8 in. (20 cm) Power injection rated to 300 psi and 10 mL/sec.</p>	470100	470100	100
 <p>Small bore extension set with removable CARESITE (LAD) valve, removable slide clamp, SPIN-LOCK connector. Components are not made with DEHP or natural rubber latex. Priming volume: 0.5 mL, Length: 8 in. (20 cm)</p>	470101	470101	100
 <p>Small bore extension set with bonded CARESITE (LAD) valve, removable slide clamp, male luer slip connector. Components are not made with DEHP or natural rubber latex. Priming volume: 0.5 mL, Length: 8 in. (20 cm)</p>	470102	470102	100
 <p>Small bore extension set with removable CARESITE (LAD) valve, removable slide clamp, male luer slip connector. Components are not made with DEHP or natural rubber latex. Priming volume: 0.5 mL, Length: 8 in. (20 cm)</p>	470103	470103	100
 <p>Small bore extension set with bonded CARESITE (LAD) valve, removable slide clamp, SPIN-LOCK connector. Components are not made with DEHP or natural rubber latex. Priming volume: 0.7 mL, Length: 14 in. (36 cm)</p>	470104	470104	100
 <p>Small bore extension set with removable CARESITE (LAD) valve, removable slide clamp, SPIN-LOCK connector. Components are not made with DEHP or natural rubber latex. Priming volume: 0.7 mL, Length: 14 in. (36 cm)</p>	470105	470105	100
 <p>Small bore T-Port Extension Set with removable CARESITE (LAD), Injection Site on SPIN-LOCK T-Port, and removable slide clamp. Priming volume: 0.5 mL, Length: 6 in. (15.0 cm)</p>	470111	470111	100
 <p>Small bore T-Port Extension Set with Female Luer Lock Connector and CARESITE (LAD) on SPIN-LOCK T-Port and slide clamp. Priming volume: 0.5 mL, Length: 5 in. (13.0 cm)</p>	470114	470114	100

Needleless Products

NEEDLELESS PRODUCTS

CARESITE® (LAD) System

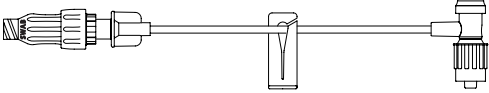
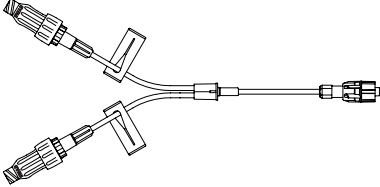
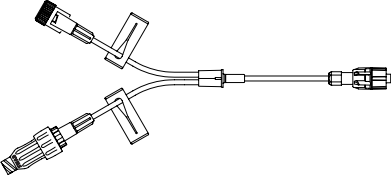
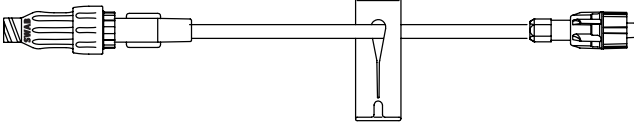
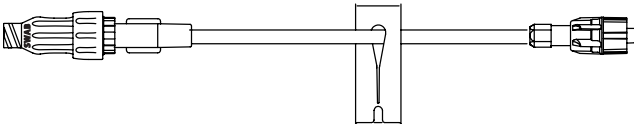
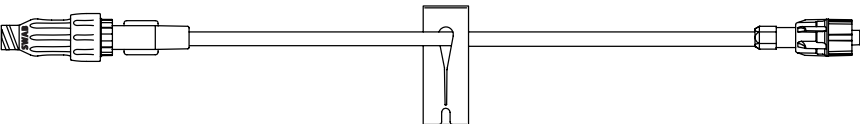
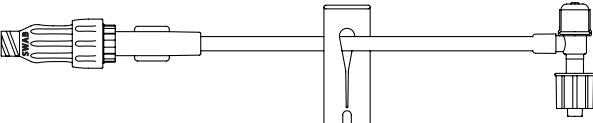
Description	Product Code	REF Number	Unit Per cs
CARESITE Small bore Extension Sets			
Components on this page are not made with DEHP or natural rubber latex.			
			
Small bore T-Port Extension Set with CARESITE (LAD), SafeLine® Injection Site on T-Port, removable slide clamp, and PE Fluid Path Tubing. Priming volume: 0.27 mL, Length: 7 in. (18 cm)	470128	470128	50
			
Small bore Y-extension set with two bonded CARESITE (LAD) valves, two slide clamps, SPIN-LOCK® connector. Priming volume: 0.9 mL, Length: 7 in. (18 cm)	470106	470106	50
			
Small bore Y-extension set with one removable CARESITE (LAD) valve, two slide clamps, SPIN-LOCK connector. Priming volume: 0.9 mL, Length: 7 in. (18 cm)	470107	470107	50
CARESITE Standard Bore Extension Sets			
			
Standard bore extension set with bonded CARESITE (LAD) valve, slide clamp, SPIN-LOCK connector. Priming volume: 0.9 mL, Length: 6 in. (15 cm)	470108	470108	100
			
Standard bore extension set with removable CARESITE (LAD) valve, slide clamp, SPIN-LOCK connector. Priming volume: 0.9 mL, Length: 6 in. (15 cm)	470109	470109	100
			
For use with power injectors - maximum 300 psi and maximum flow rate 10 mL/sec			
Standard bore extension set with bonded CARESITE (LAD) valve, kink-resistant tubing, slide clamp, SPIN-LOCK connector. Priming volume: 0.5 mL, Length: 8 in. (20 cm) Power injection rated to 300 psi and 10 mL/sec	470124	470124	100
			
Small bore T-Port extension set with removable CARESITE (LAD) valve, slide clamp and injection site on SPIN-LOCK T-Port. Priming volume: 1.5 mL, Length: 8 in. (20 cm)	470112	470112	100

CARESITE® (LAD) System

Description	Product Code	REF Number	Unit Per cs
-------------	--------------	------------	-------------

CARESITE Standard Bore Extension Sets

Components on this page are not made with DEHP or natural rubber latex.

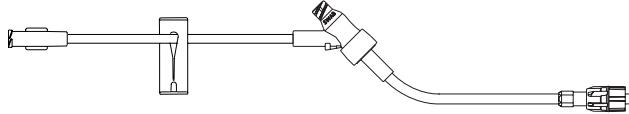

Standard bore extension set with non-removable slide clamp, CARESITE valve injection site, SPIN-LOCK® connector. Priming volume: 1.5 mL, Length: 8 in. (20 cm)

354219

354219

50

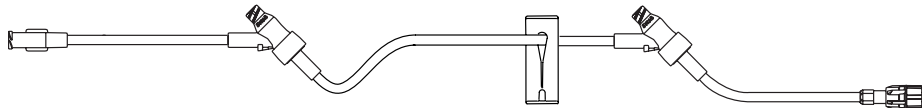

Standard bore extension set with two CARESITE valve injection sites 28 in. and 6 in. above distal end, non-removable slide clamp, SPIN-LOCK connector. Priming volume: 5.5 mL, Length: 35 in. (89 cm)

354220

354220

50

Filterflow® Filtered Extension Sets with CARESITE Injection Site

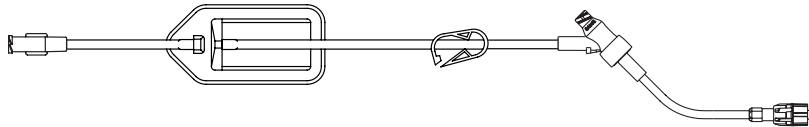

0.2 micron filter, CARESITE valve injection site 6 in. above distal end, on/off clamp, SPIN-LOCK connector. Priming volume: 5 mL, Length: 16 in. (40.6 cm)

354221

354221

50

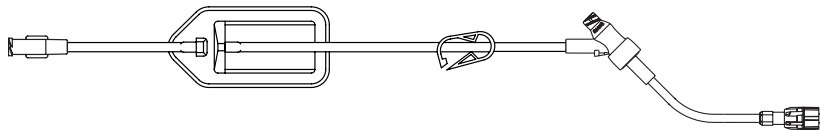

1.2 micron filter, CARESITE valve injection site 6 in. above distal end, on/off clamp, SPIN-LOCK connector. Priming volume: 5 mL, Length: 16 in. (40.6 cm)

470117

470117

50

Filterflow Filtered Administration Sets with CARESITE Injection Sites

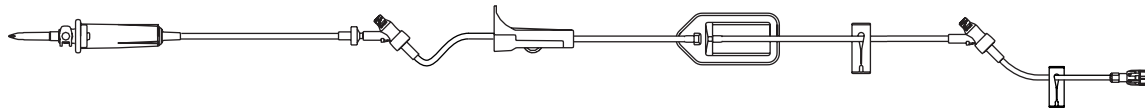

(15 drops/mL) Universal spike, backcheck valve, CARESITE injection sites 87 in. and 6 in. above distal end, roller clamp, 0.2 micron filter, slide clamp, SPIN-LOCK connector. Priming volume: 19 mL, Length: 104 in. (264.2 cm)

354207

354207

50

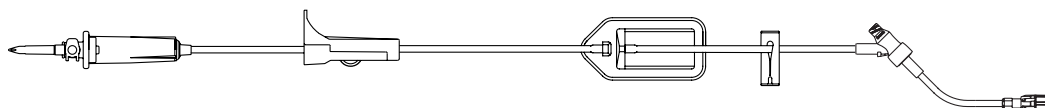



(15 drops/mL) Universal spike, roller clamp, 1.2 micron filter, slide clamp, CARESITE injection site 6 in. above distal end, SPIN-LOCK connector. Priming volume: 23 mL, Length 98 in. (248.9 cm)

470115

470115

50

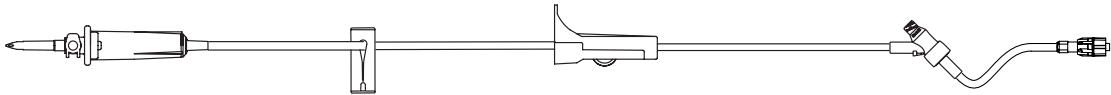
CARESITE® (LAD) System

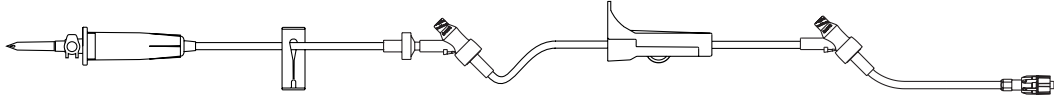
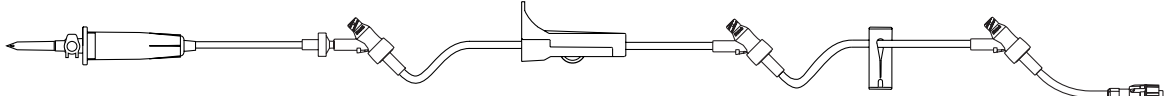
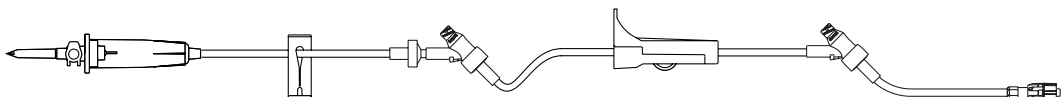
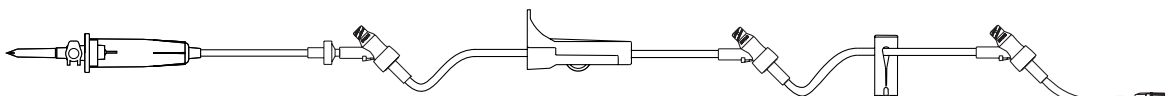
Description	Product Code	REF Number	Unit Per cs
<p>Gravity IV Administration Sets with CARESITE Injection Sites</p> <p>Components on this page are not made with DEHP or natural rubber latex.</p>  <p>(15 drops/mL) Universal spike, integrated free-flow protector¹/slide clamp², roller clamp, CARESITE injection site 6 in. above distal end, SPIN-LOCK® connector. Priming volume: 20 mL, Length: 111 in. (282 cm)</p>	354201	354201	50
 <p>(15 drops/mL) Universal spike, backcheck valve, CARESITE valve injection sites 68 in. and 6 in. above distal end, roller clamp, SPIN-LOCK connector. Priming volume: 15 mL, Length: 84 in. (210 cm)</p>	354202	354202	50
 <p>(15 drops/mL) Universal spike, slide clamp, backcheck valve, CARESITE valve injection sites 87 in. and 12 in. above distal end, roller clamp, SPIN-LOCK connector. Priming volume: 20 mL, Length: 104 in. (264 cm)</p>	354203	354203	50
 <p>(15 drops/mL) Universal spike, backcheck valve, CARESITE valve injection sites 85 in., 41 in. and 6 in. above distal end, roller clamp, slide clamp, SPIN-LOCK connector. Priming volume: 20 mL, Length: 112 in. (285 cm)</p>	354205	354205	50
 <p>(60 drops/mL) Universal spike, slide clamp, backcheck valve, CARESITE valve injection sites 87 in. and 12 in. above distal end, roller clamp, SPIN-LOCK connector. Priming volume: 19 mL, Length: 103 in. (262 cm)</p>	354204	354204	50
 <p>(60 drops/mL) Universal spike, backcheck valve, CARESITE valve injection sites 61 in., 26 in. and 6 in. above distal end, roller clamp, slide clamp, SPIN-LOCK connector. Priming volume: 17 mL, Length: 88 in. (223.5 cm)</p>	354206	354206	50

Needleless Products

CARESITE® (LAD) System

Description	Product Code	REF Number	Unit Per cs
-------------	--------------	------------	-------------

Blood Sets with CARESITE Injection Sites

Components on this page are not made with natural rubber latex.

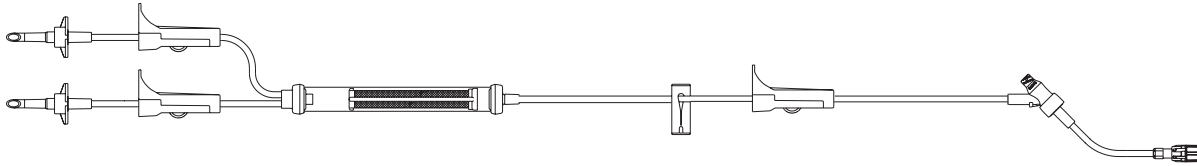

(10 drops/mL) Y-type blood set, non-vented spikes, two upper roller clamps, drip chamber with 170 micron blood filter, integrated free-flow protector/slide clamp, roller clamp, CARESITE valve injection site 6 in. above distal end, SPIN-LOCK® connector. Priming volume: 31 mL, Length: 110 in. (279.4 cm)

354217 354217 50

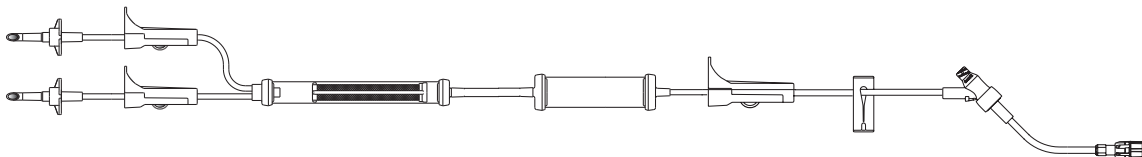

(10 drops/mL) Y-type blood set with hand pump, 170 micron filter CARESITE valve injection site 6 in. above distal end, roller clamp, slide clamp, SPIN-LOCK® connector. Priming volume: 69 mL, Length: 86 in. (218.4 cm)

354218 354218 50

Add-on Burette Set without Automatic Shutoff with CARESITE Valve

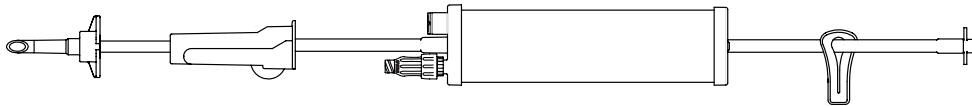

Non-vented spike, roller clamp, 150 mL burette chamber without automatic shutoff with CARESITE valve, slide clamp, spike adapter. Priming volume: 3.0 mL Length: 20 in. (51.0 cm)

470118 470118 20

Add-on Burette Set with Automatic Shutoff with CARESITE Valve

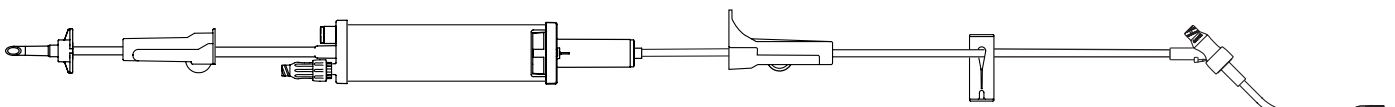

(60 drops/mL) Non-vented spike, roller clamp, 150 mL burette chamber with CARESITE valve, roller clamp, slide clamp, ULTRASITE injection site 6 in. above distal end, SPIN-LOCK connector. Priming volume: 16.0 mL Length: 88 in. (223.5 cm)

470116 470116 20

NEEDLELESS PRODUCTS

ULTRASITE® Valve Needleless System

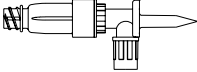
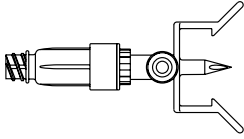
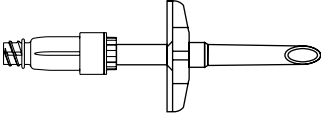
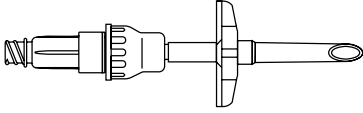
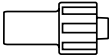
Description	Product Code	REF Number	Unit Per cs
ULTRASITE Valves			
Components on this page are not made with natural rubber latex.			
	CSU100	415110	100
Dispensing Pins with ULTRASITE Valve			
	US50	412026	50
	DP1800SC	413504	50
	US10	412027	50
	DPO4000L	412023	50
Accessories for ULTRASITE Valve			
	CSC1	654499	100

ULTRASITE® Valve Needleless System

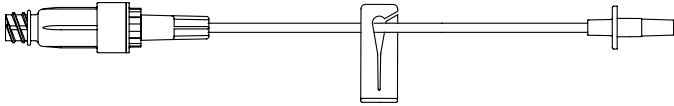
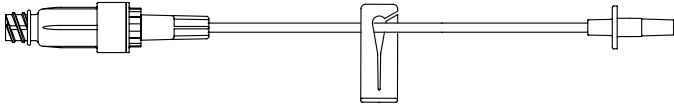
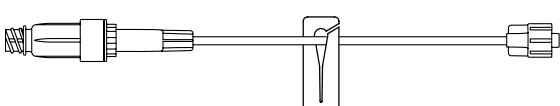
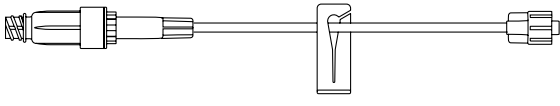
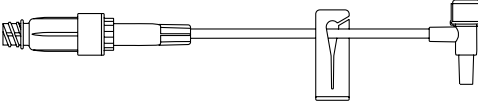
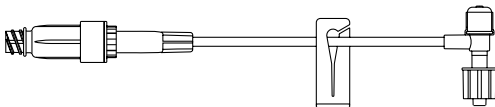
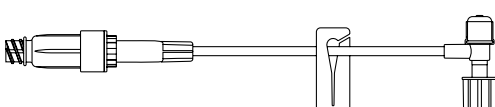
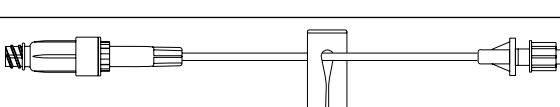
Description	Product Code	REF Number	Unit Per cs
Small Bore Extension Sets with ULTRASITE Injection Site			
Components on this page are not made with DEHP or natural rubber latex.			
 <p>Small bore extension set with removable ULTRASITE valve, removable slide clamp, male luer slip connector. Priming volume: 0.5 mL, Length: 8 in. (20 cm)</p>	CSE6S	473437	100
 <p>Small bore extension set with bonded ULTRASITE valve, removable slide clamp, male luer slip connector. Priming volume: 0.5 mL, Length: 8 in. (20 cm)</p>	CSE6SB	473446	100
 <p>Small bore extension set with ULTRASITE valve, removable slide clamp, male luer lock connector. Priming volume: 0.6 mL, Length: 8 in. (20 cm)</p>	CSE6L	473438	100
 <p>Small bore extension set with bonded ULTRASITE valve, removable slide clamp, male luer lock connector. Priming volume: 0.6 mL, Length: 8 in. (20 cm)</p>	CSE6LB	473448	100
 <p>Small bore T-port extension set with ULTRASITE valve, removable slide clamp, luer slip connector. Priming volume: 0.68 mL, Length: 5 in. (12.7 cm)</p>	CSE6TS	473440	100
 <p>Small bore T-port extension set with ULTRASITE valve, removable slide clamp, SPIN-LOCK® connector. Priming volume: 0.66 mL, Length: 5.5 in. (14.0 cm)</p>	CSE6TSL	473439	100
 <p>Small bore T-port extension set with bonded ULTRASITE valve, removable slide clamp, SPIN-LOCK connector. Priming volume: 0.68 mL, Length: 6 in. (15.2 cm)</p>	CSE6TSLB	473449	100
 <p>Small bore extension set with bonded ULTRASITE valve, non-removable slide clamp, SPIN-LOCK connector. Priming volume: 0.7 mL, Length: 8 in. (20 cm)</p>	ET08USB	470011	50

Anesthesia IV Sets

ULTRASITE® Valve Needleless System

Description	Product Code	REF Number	Unit Per cs
-------------	--------------	------------	-------------

Small Bore Extension Sets with ULTRASITE Injection Site

Components on this page are not made with DEHP or natural rubber latex.

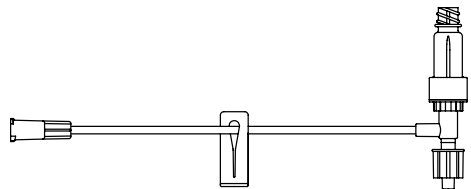

Small Bore T-port extension set with ULTRASITE valve, slide clamp, SPIN-LOCK® connector. Priming volume: 0.6 mL, Length: 5 in. (13 cm)

US04TL 474515 100

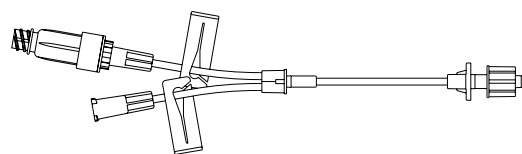

Small bore Y-extension set with removable ULTRASITE valve, removable slide clamps, SPIN-LOCK connector. Priming volume: 0.5 mL, Length: 7 in. (18 cm)

CSE6YSL 473442 100

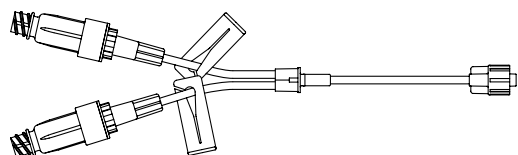

Small bore Y-extension set with two removable ULTRASITE valves, removable slide clamps, luer lock connector. Priming volume: 0.89 mL, Length: 7 in. (18 cm)

US9027 474517 50

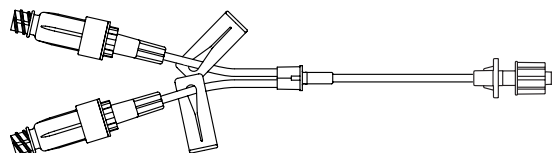

Small bore Y-extension set with two bonded ULTRASITE valves, two slide clamps, SPIN-LOCK connector. Priming volume: 0.9 mL, Length: 7 in. (18 cm)

ET07US 470021 50

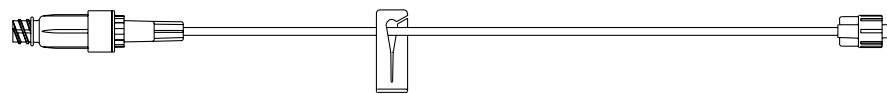

Small bore extension set with removable ULTRASITE valve, removable slide clamp, luer lock connector. Priming volume: 0.73 mL, Length: 14 in. (36 cm)

CSE12L 473441 100

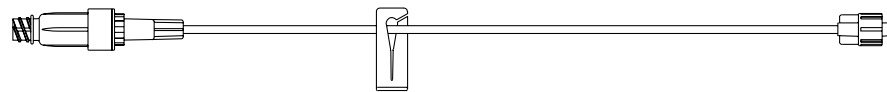

Small bore extension set with bonded ULTRASITE valve, removable slide clamp, luer lock connector. Priming volume: 0.5 mL, Length: 14 in. (36 cm)

CSE12LB 473445 100

ULTRASITE® Valve Needleless System

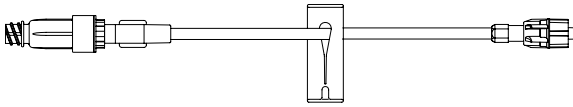
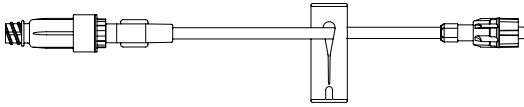
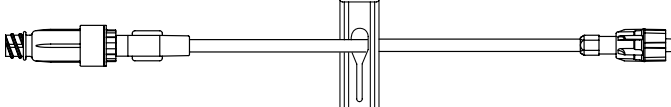
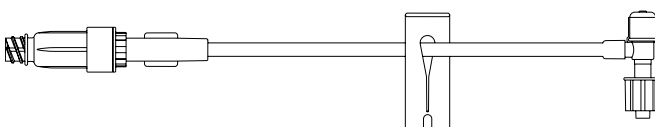
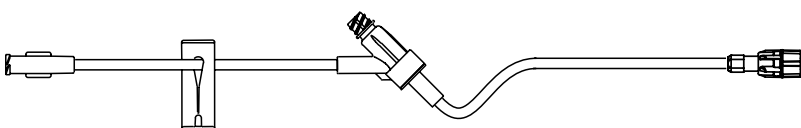
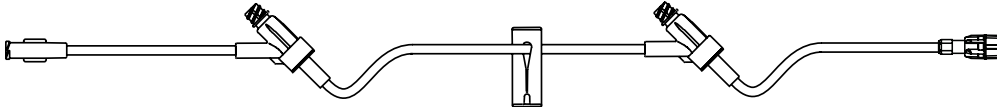
Description	Product Code	REF Number	Unit Per cs
Standard Bore Extension Sets with ULTRASITE Injection Site			
 <p>Standard bore extension set with ULTRASITE valve, non-removable slide clamp, SPIN-LOCK® connector. Components are not made with DEHP or natural rubber latex. Priming volume: 0.7 mL, Length: 6.5 in. (17 cm)</p>	CSE8SL	473444	100
 <p>Standard bore extension set with bonded ULTRASITE valve, non-removable slide clamp, SPIN-LOCK connector. Components are not made with DEHP or natural rubber latex. Priming volume: 1.0 mL, Length: 6 in. (15 cm)</p>	CSE8SLB	473447	100
 <p>Extension set with bonded ULTRASITE valve, kink-resistant tubing, non-removable slide clamp, SPIN-LOCK connector. Components are not made with natural rubber latex. Priming volume: 0.68 mL, Length: 7 in. (18 cm)</p>	US1320	474921	50
 <p>Standard bore T-port extension set with ULTRASITE valve, non-removable slide clamp, SPIN-LOCK connector. Components are not made with DEHP or natural rubber latex. Priming volume: 1.3 mL, Length: 7.5 in. (18.8 cm)</p>	CSE8TSL	473443	100
 <p>Standard bore extension set with non-removable slide clamp, ULTRASITE valve injection site, SPIN-LOCK® connector. Components are not made with DEHP or natural rubber latex. Priming volume: 1.5 mL, Length: 8 in. (20 cm)</p>	US9060	474580	50
 <p>Standard bore extension set with two ULTRASITE valve injection sites 28 in. and 6 in. above distal end, non-removable slide clamp, SPIN-LOCK connector. Components are not made with DEHP or natural rubber latex. Priming volume: 5.5 mL, Length: 35 in. (89 cm)</p>	CSE33SL	473436	50

ULTRASITE® Valve Needleless System

Description	Product Code	REF Number	Unit Per cs
-------------	--------------	------------	-------------

Filterflow® Filtered Extension Sets with ULTRASITE Injection Sites

Components on this page are not made with DEHP or natural rubber latex.

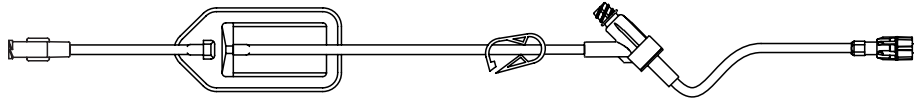

0.2 micron filter, ULTRASITE injection site 6 in. above distal end, slide clamp, on/off clamp, SPIN-LOCK® connector. Priming volume: 5.2 mL, Length: 16 in. (40.6 cm)	US1380F	473992	50
---	---------	--------	----

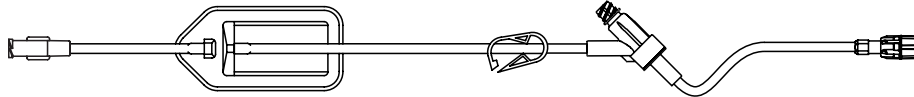

1.2 micron filter, ULTRASITE injection site 6 in. above distal end, slide clamp, on/off clamp, SPIN-LOCK connector. Priming volume: 5 mL, Length: 16 in. (40.6 cm)	US1385F	473997	50
--	---------	--------	----

Filterflow Low Volume Filtered Extension Sets with ULTRASITE Injection Sites

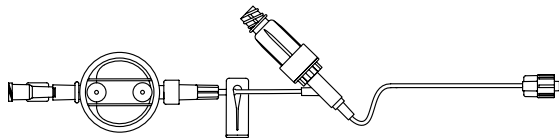

Female luer connector, 1.2 micron low volume SUPOR® filter with female luer connector, slide clamp, ULTRASITE injection site 3 in. above distal end, male luer lock connector. Priming volume: 0.9 mL, Length: 9 in. (22.9 cm)	US1207PF	474000	50
--	----------	--------	----

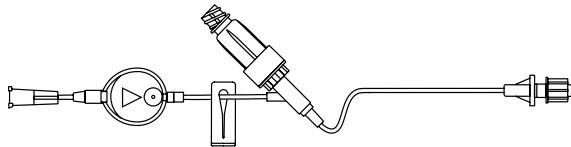

Female luer connector, 0.2 micron micro volume SUPOR filter with female luer connector, slide clamp, ULTRASITE injection site 3 in. above distal end, SPIN-LOCK connector. Priming volume: 0.7 mL, Length: 7 in. (18 cm)	US2007MF	473999	50
--	----------	--------	----

SUPOR is a registered trademark of Pall Corporation

ULTRASITE® Valve Needleless System

Description	Product Code	REF Number	Unit Per cs
-------------	--------------	------------	-------------

Gravity IV Administration Sets with ULTRASITE Injection Sites

Components on this page are not made with DEHP or natural rubber latex.

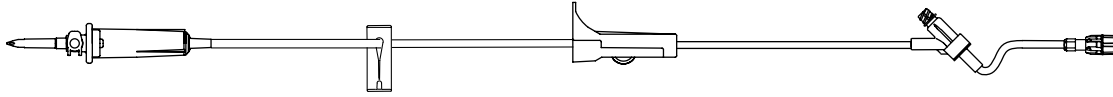

(15 drops/mL) Universal spike, slide clamp, roller clamp, ULTRASITE injection site 6 in. above distal end, SPIN-LOCK® connector. Priming volume: 20 mL, Length: 111 in. (282 cm)

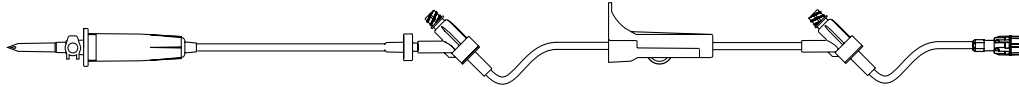

(15 drops/mL) Universal spike, backcheck valve, ULTRASITE valve injection sites 68 in. and 6 in. above distal end, roller clamp, SPIN-LOCK connector. Priming volume: 15 mL, Length: 84 in. (210 cm)

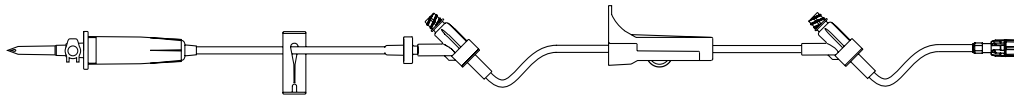

(15 drops/mL) Universal spike, slide clamp, backcheck valve, ULTRASITE valve injection sites 87 in. and 12 in. above distal end, roller clamp, SPIN-LOCK connector. Compatible with VISTA® basic Pump. Priming volume: 20 mL, Length: 104 in. (264 cm)

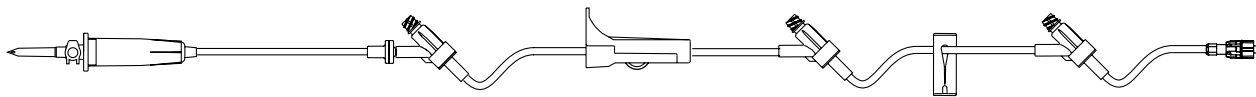

(15 drops/mL) Universal spike, backcheck valve, ULTRASITE valve injection sites 85 in., 41 in. and 6 in. above distal end, roller clamp, slide clamp, SPIN-LOCK connector. Priming volume: 20 mL, Length: 112 in. (285 cm)

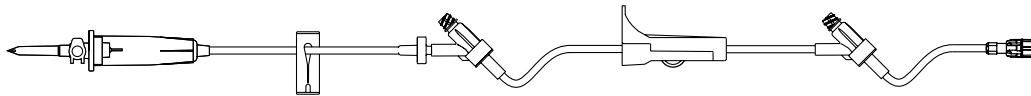

(60 drops/mL) Universal spike, slide clamp, backcheck valve, ULTRASITE valve injection sites 87 in. and 12 in. above distal end, roller clamp, SPIN-LOCK connector. Priming volume: 19 mL, Length: 103 in. (262 cm)

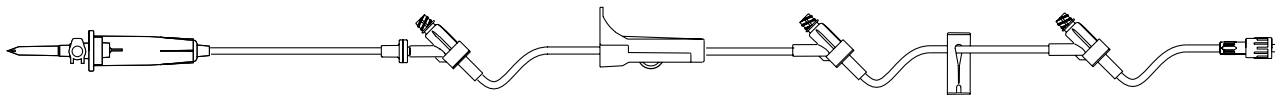

(60 drops/mL) Universal spike, backcheck valve, ULTRASITE valve injection sites 61 in., 26 in. and 6 in. above distal end, roller clamp, slide clamp, SPIN-LOCK connector. Priming volume: 17 mL, Length: 88 in. (223.5 cm)

* Compatible with VISTA® basic Pump

ULTRASITE® Valve Needleless System

Description	Product Code	REF Number	Unit Per cs
-------------	--------------	------------	-------------

Filterflow® Filtered Administration Sets with ULTRASITE Injection Sites

Components on this page are not made with DEHP or natural rubber latex.

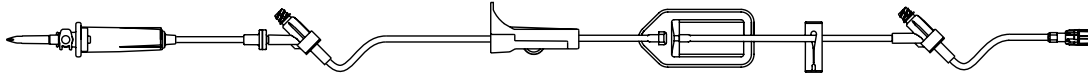

(15 drops/mL) Universal spike, backcheck valve, ULTRASITE injection sites 87 in. and 6 in. above distal end, slide clamp, roller clamp, 0.2 micron filter, slide clamp, SPIN-LOCK® connector. Priming volume: 19 mL, Length: 104 in. (264.2 cm)	US8801F	352437	50
---	---------	--------	----

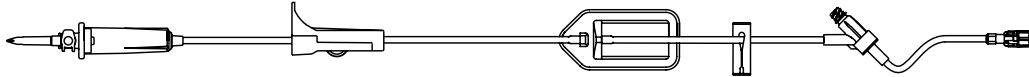

(15 drops/mL) Universal spike, integrated free-flow protector ¹ /slide clamp ² , roller clamp, 1.2 micron filter, slide clamp, ULTRASITE injection site 6 in. above distal end, SPIN-LOCK connector. Priming volume: 23 mL, Length 98 in. (248.9 cm)	US8812F	US8812F	50
--	---------	---------	----

Emergency Medical Services Sets with ULTRASITE Injection Sites

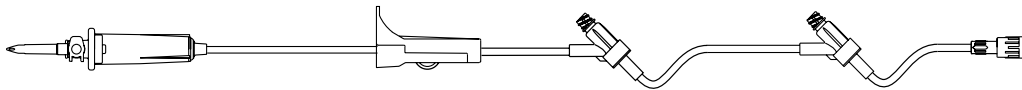

(15 drops/mL) Universal spike, roller clamp, ULTRASITE valve injection sites 8 in. and 3 in. above distal end, SPIN-LOCK connector. Priming volume: 16 mL, Length: 86 in. (218 cm)	US1150	US1150	50
--	--------	--------	----

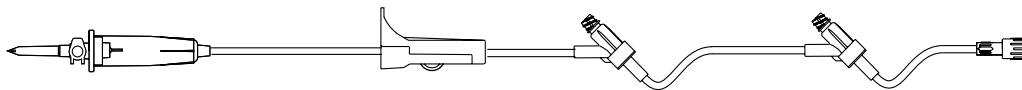

(60 drops/mL) Universal spike, roller clamp, ULTRASITE valve injection sites 8 in. and 3 in. above distal end, SPIN-LOCK connector. Priming volume: 14 mL, Length: 86 in. (218 cm)	US1155	352379A*	50
--	--------	----------	----

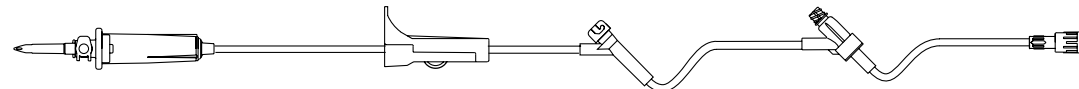

(15 drops/mL) Universal spike, roller clamp, SAFELINE® injection site 8 in. above distal end, ULTRASITE valve injection site 3 in. above distal end, SPIN-LOCK connector. Priming volume: 15 mL, Length: 86 in. (218.4 cm)	US1160	US1160	50
--	--------	--------	----

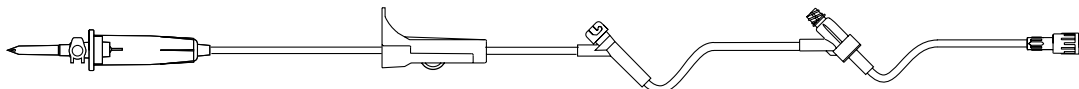

(60 drops/mL) Universal spike, roller clamp, SAFELINE injection site 8 in. above distal end, ULTRASITE valve injection site 3 in. above distal end, SPIN-LOCK connector. Priming volume: 15 mL, Length: 86 in. (218.4 cm)	US1165	352237	50
---	--------	--------	----

* Compatible with VISTA® basic Pump

ULTRASITE® Valve Needleless System

Description	Product Code	REF Number	Unit Per cs
-------------	--------------	------------	-------------

Blood Sets with ULTRASITE Injection Sites

Components on this page are not made with natural rubber latex.

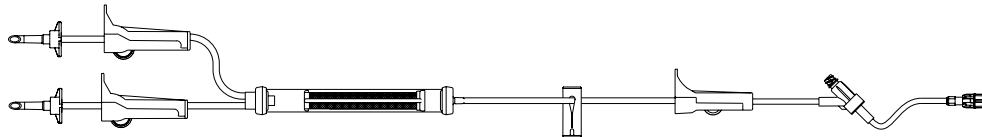

(10 drops/mL) Y-Type blood set, non-vented spikes, two upper roller clamps, drip chamber with 170 micron blood filter, slide clamp, roller clamp, ULTRASITE valve injection site 6 in. above distal end, SPIN-LOCK® connector. Priming volume: 31 mL Length: 112 in. (284.5 cm)	US8850*	US8850*	50
---	---------	---------	----

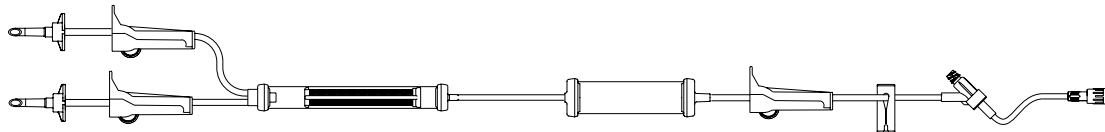

(10 drops/mL) Y-Type blood set with hand pump, 170 micron filter, ULTRASITE valve injection site 6 in. above distal end, roller clamp, slide clamp, SPIN-LOCK connector. Priming volume: 72 mL Length: 86 in. (218 cm)	US5145	375154	50
--	--------	--------	----

Add-on Burette Set without Automatic Shutoff with ULTRASITE Valve

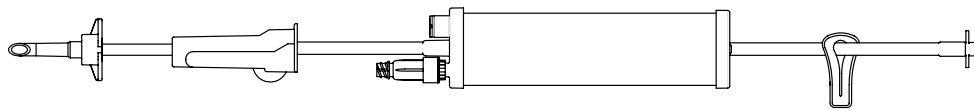

Non-vented spike, roller clamp, 150 mL burette chamber without automatic shutoff with ULTRASITE valve, slide clamp, spike adapter. Priming volume: 3.0 mL Length: 20 in. (51.0 cm)	375111	375111	20
--	--------	--------	----

Add-on Burette Set with Automatic Shutoff with ULTRASITE Valve

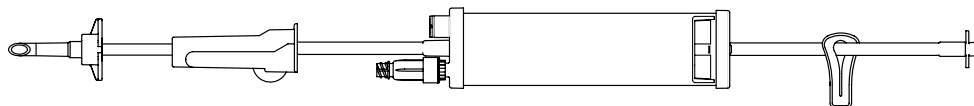

Non-vented spike, roller clamp, 150 mL burette chamber with ULTRASITE valve, slide clamp, spike adapter. Priming volume: 3.0 mL Length: 20 in. (51 cm)	375059	375059	20
--	--------	--------	----

Burette Administration Set with Automatic Shutoff and ULTRASITE Injection Sites

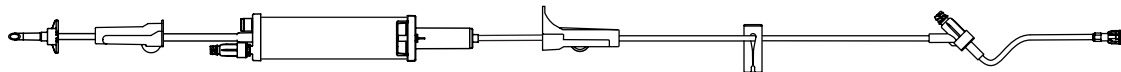

(60 drops/mL) Non-vented spike, roller clamp, 150 mL burette chamber with ULTRASITE valve, roller clamp, slide clamp, ULTRASITE injection site 6 in. above distal end, SPIN-LOCK connector. Priming volume: 16.0 mL Length: 88 in. (223.5 cm)	US1540M	375137	20
---	---------	--------	----

* Compatible with VISTA® basic Pump

Needleless Products

ULTRASITE® Valve Needleless System

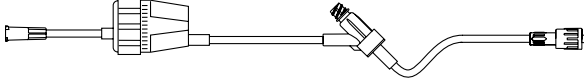
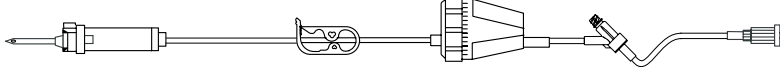
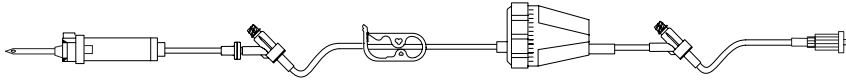
Description	Product Code	REF Number	Unit Per cs
<p>Rate Flow® Regulator Set with ULTRASITE Injection Sites</p> <p>Components on this page are not made with DEHP or natural rubber latex.</p>  <p>Female adapter, Rate Flow Regulator, ULTRASITE valve injection site 6 in. above distal end, SPIN-LOCK connector. Priming volume: 2.6 mL, Length: 18 in. (46 cm)</p>	US5300	US5300	50
 <p>(20 drops/mL) Universal spike, on/off clamp, Rate Flow Regulator, ULTRASITE valve injection site 6 in. above distal end, SPIN-LOCK connector. Priming volume: 16.3 mL, Length: 83.66 in. (212.5 cm)</p>	US5322	375152	50
 <p>(20 drops/mL) Universal spike, backcheck valve, on/off clamp, Rate Flow Regulator, 2 ULTRASITE valve injection sites 70 in. and 6 in. above the distal end, SPIN-LOCK connector. Priming volume: 18 mL, Length: 90.16 in. (229 cm)</p>	US5932	375153	50

Accessories for ULTRASITE valve

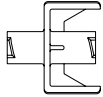
 <p>Luer slip adapter. Provides a secure connection between a male luer slip connector and the ULTRASITE valve.</p>	CSC1	654499	100
 <p>Fluid dispensing connector – proximal and distal female luer lock connector. Used for pre-filling unit dose syringes from a large master syringe (color – green). Allows for the transfer of blood from a collecting syringe to a Vacutainer® tube without the use of a needle.</p>	FDC1000	415080	100

* for injection only

SAFELINE® Needleless System

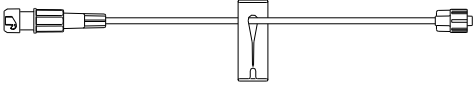
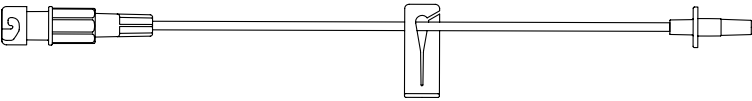
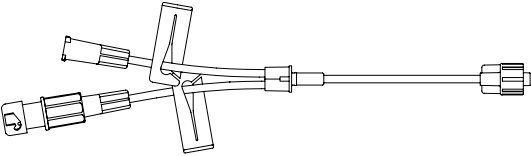
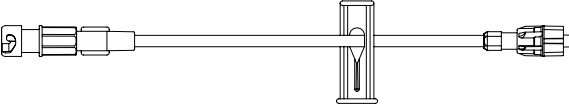
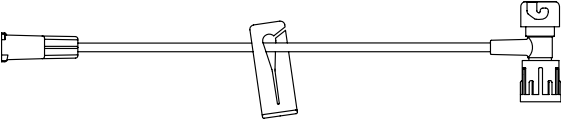
Description	Product Code	REF Number	Unit Per cs
Extension Sets with SAFELINE Split Septum Injection Sites			
	NF1310	NF1310	50
<p>SAFELINE split septum injection site, removable slide clamp, microbore tubing, male luer lock connector. Components are not made with natural rubber latex. Priming volume: 0.42 mL, Length: 7 in. (17.8 cm)</p>			
	NF1312	NF1312	50
<p>SAFELINE split septum injection site, removable slide clamp, microbore tubing, male luer slip connector. Components are not made with natural rubber latex. Priming volume: 0.5mL, Length: 8 in. (20.32 cm)</p>			
	NF1318	NF1318	100
<p>Y-type small bore extension set with attached SAFELINE split septum injection site, female adapter, two removable slide clamps, male luer lock connector. Components are not made with DEHP or natural rubber latex. Priming volume: 0.5 mL, Length: 7 in. (17.8 cm)</p>			
	NF1320	NF1320	50
<p>Small bore extension set with SAFELINE split septum injection site, kink-resistant tubing, removable slide clamp, SPIN-LOCK® connector. Components are not made with natural rubber latex. Priming volume: 0.63 mL, Length: 7 in. (17.8 cm)</p>			
	NF1330	NF1330	50
<p>Female adapter, microbore tubing, removable slide clamp, T-connector with SAFELINE split septum injection site., SPIN-LOCK connector. Components are not made with DEHP or natural rubber latex. Priming volume: 0.27 mL, Length: 6 in. (15.2 cm)</p>			

SAFELINE® Needleless System

Description	Product Code	REF Number	Unit Per cs
-------------	--------------	------------	-------------

Extension Sets with SAFELINE Split Septum Injection Sites (continued)

Components on this page are not made with DEHP or natural rubber latex.

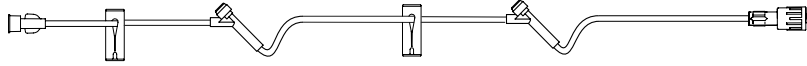

Female adapter, large bore tubing, slide clamp, SAFELINE split septum injection sites 28 in. and 6 in. above distal end, slide clamp, SPIN-LOCK® connector. Priming volume: 6.0 mL, Length: 35 in. (89 cm)

NF1370	NF1370	50
--------	--------	----

Filterflow® Filtered Add-on Extension Set with SAFELINE Split Septum Injection Site

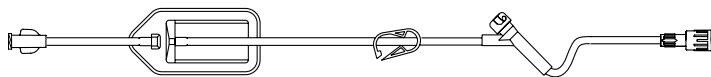

Female luer lock, 0.2 micron filter, SAFELINE split septum injection site 6 in. above distal end, on/off clamp, SPIN-LOCK connector. Priming volume: 5.3 mL, Length 16 in. (41 cm)

NF1380F	473993	50
---------	--------	----

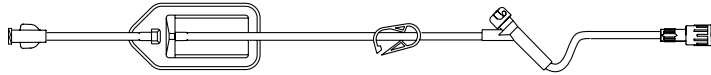

Female luer lock, 1.2 micron filter, SAFELINE split septum injection site 6 in. above distal end, on/off clamp, SPIN-LOCK connector. Priming volume: 5.1 mL, Length 16 in. (40.0 cm)

NF1385F	473998	50
---------	--------	----

Basic Administration Sets with SAFELINE Split Septum Injection Site

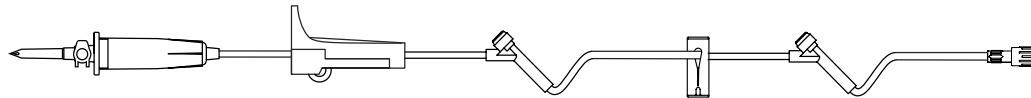

(15 drops/mL) Universal spike, roller clamp, SAFELINE split septum injection sites 40 in. and 6 in. above distal end, slide clamp, SPIN-LOCK connector. Priming volume: 19.0 mL, Length: 90 in. (228 cm)

NF1150	NF1150	50
--------	--------	----

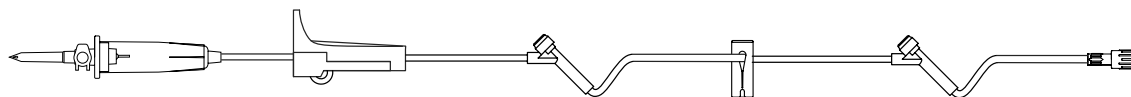

(60 drops/mL) Universal spike, roller clamp, SAFELINE split septum injection sites 38 in. and 6 in. above distal end, slide clamp, SPIN-LOCK connector. Priming volume: 18 mL, Length: 94 in. (239 cm)

NF1190	NF1190	50
--------	--------	----

Secondary Set for use with SAFELINE Split Septum Injection Site

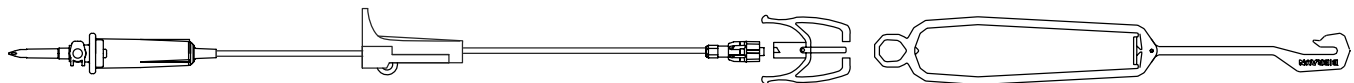

(15 drops/mL) Universal spike, roller clamp, SPIN-LOCK connector, SAFELINE Clip Lock® cannula, 10.5" plastic bag hanger. Priming volume: 10.2 mL, Length: 49 in. (125 cm)

	NF1430	50
--	--------	----

Needleless Products

SAFELINE® Needleless System

Description	Product Code	REF Number	Unit Per cs
-------------	--------------	------------	-------------

ADDitIV® Primary Administration Sets with Backcheck Valve and SAFELINE Split Septum Injection Sites

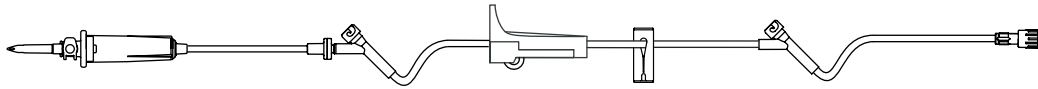

(15 drops/mL) Universal spike, backcheck valve, SAFELINE split septum injection sites 80 in. and 6 in. above distal end, roller clamp, SPIN-LOCK® connector. Components are not made with DEHP or natural rubber latex. Priming volume: 19 mL, Length: 104 in. (264 cm)

NF1585

352604

50

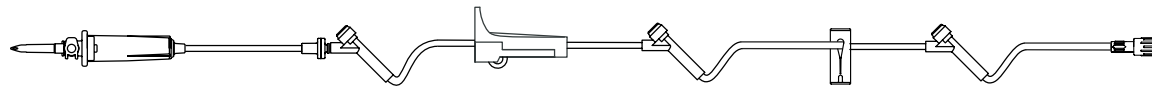

(15 drops/mL) Universal spike, backcheck valve, SAFELINE split septum injection sites 88 in., 30 in. and 6 in. above distal end, roller clamp, slide clamp, SPIN-LOCK connector. Components are not made with DEHP or natural rubber latex. Priming volume: 19.68 mL, Length: 111 in. (282 cm)

NF1251

NF1251

50

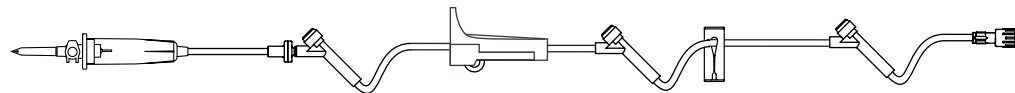

(60 drops/mL) Universal spike, backcheck valve, SAFELINE split septum injection sites 62 in., 27 in. and 6 in. above distal end, roller clamp, slide clamp, SPIN-LOCK connector. Components are not made with DEHP or natural rubber latex. Priming volume: 17 mL, Length: 88 in. (223.5 cm)

NF1290

NF1290

50

Blood Administration Sets with SAFELINE Split Septum Injection Site

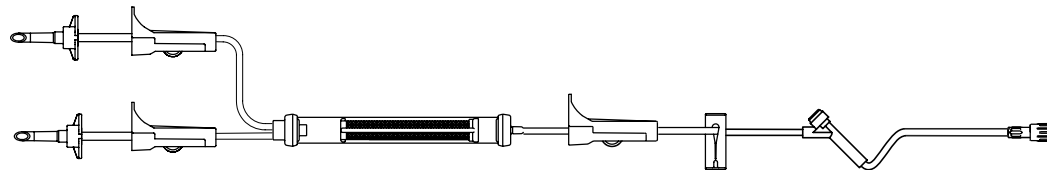

(10 drops/mL) Y-type, non-vented spikes, drip chamber with 170 micron blood filter, three roller clamps, slide clamp, SAFELINE split septum injection site 6 in. above distal end, SPIN-LOCK connector. Components are not made with natural rubber latex. Priming volume: 34 mL, Length: 84 in. (213 cm)

NF5140

NF5140

50

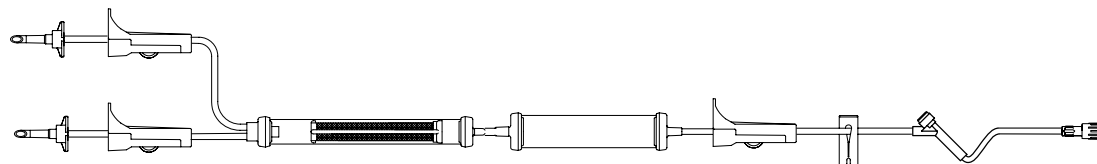

(10 drops/mL) Y-type, non-vented spikes, drip chamber with 170 micron blood filter, pump chamber, three roller clamps, slide clamp, SAFELINE split septum injection site 6 in. above distal end, SPIN-LOCK connector. Components are not made with natural rubber latex. Priming volume: 72 mL, Length: 86 in. (218 cm)

NF5145

NF5145

50

Needleless Products

SAFELINE® Needleless System

Description	Product Code	REF Number	Unit Per cs
-------------	--------------	------------	-------------

Filterflow® Filtered Gravity Administration Sets with SAFELINE Split Septum Injection Sites

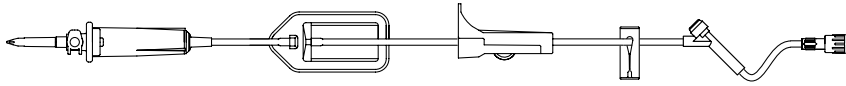

(15 drops/mL) Universal spike, 0.2 micron filter, SAFELINE split septum injection site 6 in. above distal end, SPIN-LOCK® connector. Components are not made with DEHP or natural rubber latex. Priming volume: 21.0 mL, Length: 89 in. (226 cm)

NF1225F 352434 50

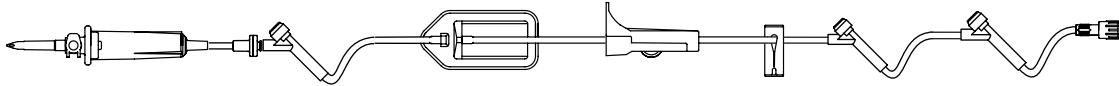

(15 drops/mL) Universal spike, 0.2 micron filter, backcheck valve, SAFELINE split septum injection sites 84 in., 26 in. and 6 in. above distal end, SPIN-LOCK connector. Components are not made with DEHP or natural rubber latex. Priming volume: 21 mL, Length: 111 in. (281.9 cm)

NF1210F NF1210F 50

Extension Set with Rate Flow® Regulator and SAFELINE Split Septum Injection Site

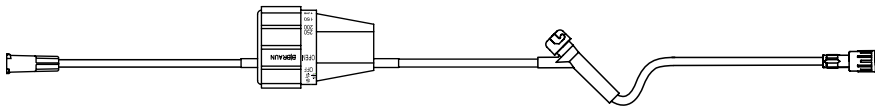

Female adapter, Rate Flow Regulator, SAFELINE split septum injection site 6 in. above distal end, SPIN-LOCK connector. Components are not made with DEHP or natural rubber latex. Priming volume: 2.6 mL, Length: 18 in. (46 cm)

NF5300 NF5300 50

ADDitIV® Primary Administration Set with Backcheck Valve and Rate Flow® Regulator and SAFELINE Split Septum Injection Sites

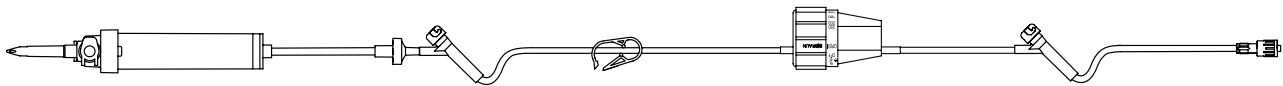

(20 drops/mL) Universal spike, 15 micron filter, backcheck valve, Rate Flow Regulator, SAFELINE split septum injection sites 54 in. and 6 in. above distal end, SPIN-LOCK connector. Components are not made with DEHP or natural rubber latex. Priming volume: 18 mL, Length: 90.16 in. (229 cm)

NF5932 NF5932 50

SAFELINE® Needleless System

Description	Product Code	REF Number	Unit Per cs
-------------	--------------	------------	-------------

SAFELINE Needleless Split Septum Injection Site

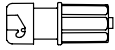

SAFELINE split septum injection site, male luer lock connector. Components are not made with DEHP or natural rubber latex. Priming volume: 0.25 mL

NF9100 NF9100 400

Accessories for SAFELINE Split Septum Injection Site

Components on this page are not made with DEHP or natural rubber latex.

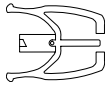

SAFELINE Clip Lock® cannula; locking cannula with female luer.

NF9200 NF9200 400

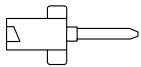

SAFELINE Blunt Cannula; blunt cannula with female luer.

NF9210 NF9210 400

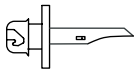

SAFELINE multidose vial adapter

NF9280 NF9280 100

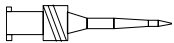



Medic® plastic anti-stick needle/connector.

M8-5007 M8-5007 1,000

InVision-Plus® Needleless Connector with Neutral Advantage Technology

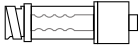
The InVision-Plus Needleless Connector with Neutral Advantage Technology is a neutral fluid displacement needleless I.V. connector that combines split septum seal integrity and double microbial barrier with a simple, internal cannula design having no moving parts within the fluid pathway.

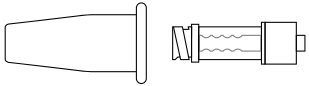
Description	Product Code	REF Number	Unit Per cs
InVision-Plus Clear PEEL POUCH			
 <p>Needleless connector for aspiration, injection or gravity flow of fluid upon insertion of a male luer fitting. Components not made with DEHP or natural rubber latex. Priming volume: 0.027 mL. Power injection rated to 325 psi and 10 mL/sec.</p>	415303	415303	1,000
InVision-Plus PEEL POUCH*			
 <p>Needleless connector for aspiration, injection or gravity flow of fluid upon insertion of a male luer fitting. Components not made with DEHP or natural rubber latex. Priming volume: 0.027 mL. Power injection rated to 325 psi and 10 mL/sec.</p>	415302	415302*	1,000
InVision-Plus Clear TOUCH-FREE™*			
 <p>Needleless connector for aspiration, injection or gravity flow of fluid upon insertion of a male luer fitting. Components not made with DEHP or natural rubber latex. Priming volume: 0.027 mL. Power injection rated to 325 psi and 10 mL/sec.</p>	415301	415301*	1,000

InVision-Plus Extension Sets

All catheter extension sets are made of kink-resistant, NON-DEHP PVC Tubing. All products and packaging are not made with natural rubber latex.

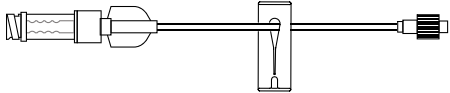
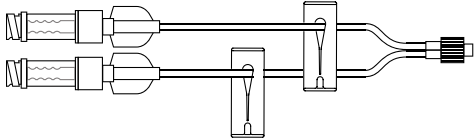
 <p>Microbore extension set with removable InVision-Plus Clear (LAD) needleless connector, slide clamp, fixed male luer lock connector. Priming volume: 0.27 mL, Length: 7 in. (18 cm)</p>	460205	460205	400
 <p>Microbore high pressure Y-extension set with two removable InVision-Plus Clear (LAD) needleless connectors, two slide clamps, rotating collar male luer lock. Set rated to 325 psi. Priming volume: 0.45 mL, Length: 7 in. (18 cm).</p>	460206	460206	400

* Available soon. Contact you sales representative for availability.

InVision-Plus is a registered trademark and TOUCH-FREE is a trademark of RyMed Technologies, LLC

Description	Product Code	REF Number	Unit Per cs
-------------	--------------	------------	-------------

InVision-Plus® Extension Sets (continued)

All catheter extension sets are made of kink-resistant, NON-DEHP PVC Tubing. All products and packaging are not made with natural rubber latex.

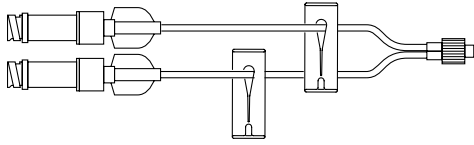

Microbore high pressure Y-extension set with two removable InVision-Plus (LAD) needleless connectors, two slide clamps, rotating collar male luer lock. Set rated to 325 psi. Priming volume: 0.45 mL, Length: 7 in. (18 cm).	460202	460202*	400
---	--------	---------	-----

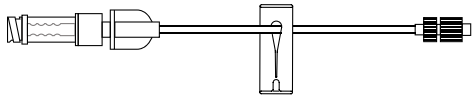

Macrobore high pressure extension set with removable InVision-Plus Clear (LAD) needleless connector, slide clamp, universal male luer lock. Set rated to 325 psi. Priming volume: 0.42 mL, Length: 7 in. (18 cm).	460207	460207	400
---	--------	--------	-----

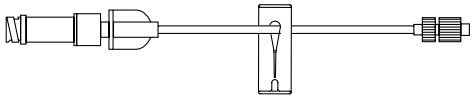

Macrobore high pressure extension set with removable InVision-Plus (LAD) needleless connector, slide clamp, universal male luer lock. Set rated to 325 psi. Priming volume: 0.42 mL, Length: 7 in. (18 cm).	460203	460203*	400
---	--------	---------	-----

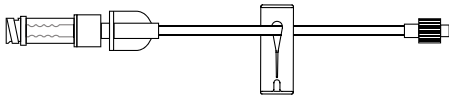

Standard bore extension set with removable InVision-Plus Clear (LAD) needleless connector, slide clamp, fixed collar male luer lock. Priming volume: 1.32 mL, Length: 7 in. (18 cm).	460208	460208	400
--	--------	--------	-----

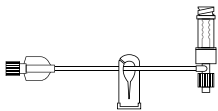

Microbore T-Port extension set with removable InVision-Plus Clear (LAD) needleless connector, removable slide clamp, rotating collar male luer lock. Priming volume: 0.26 mL, Length: 4 in. (10 cm).	460204	460204*	400
--	--------	---------	-----

* Available soon. Contact you sales representative for availability.
InVision-Plus is a registered trademark of RyMed Technologies, LLC

General Ordering Information and Terms of Sale

Thank you for your interest in B. Braun Medical Inc. ("B. Braun") products. The following provisions set forth the terms and conditions on which B. Braun sells its products.

Terms of Sale: Purchase of any products sold by B. Braun shall be subject to and expressly limited by the terms and conditions contained herein. No changes to, waiver of, or addition to any of these terms and conditions shall be effective unless agreed to in writing and signed by B. Braun. Buyer acknowledges and agrees that these terms and conditions supersede the terms and conditions of any purchase order or other documentation used by Buyer and, except for delivery and billing addresses, and quantities prices and items ordered, any conflicting or additional terms are void and have no effect, but that Buyer may place orders by use of purchase orders and other documentation for its convenience purposes only. Notwithstanding the foregoing, B. Braun reserves the right at any time to amend these terms and conditions, and Buyer shall be deemed to accept such amended terms and conditions by ordering products herein offered after the date of such amendment. Additional special terms and conditions of B. Braun may be applicable with respect to certain products.

Minimum Order Quantity: All products must be ordered in full case quantities. Orders received with a value of less than \$250.00 will be subject to a handling charge of \$40.00. Wholesalers and Distributors are subject to a handling charge of \$75.00 for orders less than \$1,000.00.

Prices: All pricing quotes must be documented in writing and signed by B. Braun to be valid. Prices quoted, unless otherwise stated, refer to full case quantities. All prices are firm for 30 days from the date quoted. B. Braun reserves the right to change the prices and specifications of its products at any time without notice.

Products purchased from distributors will be at the prices set by those distributors and subject to the terms and conditions of sale of the distributor.

Tax Information: Any tax, assessment, duty, custom or other fee of any nature imposed upon the products, their sale, transportation, delivery, use or consumption shall be paid by Buyer in addition to the price quoted or invoiced. If B. Braun is required to prepay any such tax or fee, Buyer will reimburse B. Braun. Buyer must provide B. Braun with a resale/exemption certificate in order to avoid the withholding of applicable taxes. No refund or adjustment to previously withheld taxes will be made by B. Braun sixty (60) days after the invoice date. Proof of certification should be mailed to: B. Braun Medical Inc., 824 Twelfth Avenue, Bethlehem, PA 18018-0027.

Payment: Payment terms are net 30 days from date of invoice. Credit card payments will not be accepted without prior approval from B. Braun. Buyer's obligation to pay outstanding invoices and all other amounts is absolute and unconditional and is not subject to any abatement, reduction, set-off, defense, counterclaim, interruption, deferment or recoupment for any reason whatsoever. Balances remaining unpaid at due date are subject to an interest charge of 1.5% per month or the highest rate permitted by law, whichever is lower, until paid.

Any discounts, rebates, administrative fees, credits, or other fees due or owed to Buyer will be applied against delinquent balances before payment or reimbursement is made.

Any disputed amounts should be reported immediately and remitted with the undisputed amount by the payment due date. If B. Braun agrees with the billing dispute, B. Braun will credit Buyer the amount of the agreed-upon billing dispute. All billing disputes must be made within six (6) months of the applicable invoice date, or will be deemed to be waived.

B. Braun reserves the right in its sole discretion to require prepayment from any Buyer at any time and may refuse to sell and/or withhold further shipment until all overdue balances are made current. Buyer shall be liable for, and shall reimburse B. Braun for all costs and expenses it may incur in connection with collection of any amounts owed to B. Braun or enforcement of its rights, including without limitation, reasonable attorneys' fees and expenses, court costs, and cost of collection agencies.

Returned Goods Policy: Product returns are subject to the following conditions:

1. All returns are subject to the prior authorization of B. Braun, in its discretion. Buyer must notify Customer Support at (800) 227-2862 and complete a Return Request Form. The Return Request Form requires lot numbers, quantities and catalog numbers along with a specific reason for return. Customer Support will either authorize or deny the request for return. Only items appearing on an approved Return document are acceptable for return. Product returns will only be accepted from the original purchaser. Product returns will not be accepted from third party return companies. Unauthorized returns will be destroyed and no credit issued. All authorized returned goods must be shipped freight prepaid to the B. Braun location indicated on the Return document, except B. Braun will pay freight costs for Product shipped-in-error.
2. All Products returned within 30 days of delivery are subject to a 25% restocking charge, except for Products shipped-in-error. Products returned after 30 days are considered excess stock and will be eligible for 50% credit. No Products will be accepted for return after 90 days from the date of delivery.

3. Subject to paragraph 2 above, credit will be issued at the net purchase price for all authorized returns provided:
 - a. Products have at least one year shelf-life remaining, or products with original expiration dating of eighteen months or less have at least six months shelf-life remaining.
 - b. Proper authorization has been obtained prior to return of products.
 - c. Products are in their original packaging.
 - d. Products are current inventory items.
 - e. The Products have been shipped and billed to Buyer by B. Braun, and Buyer has paid for said Products.

4. Certain Products are not eligible for return. These are:
 - a. Products that have deteriorated because of improper storage, handling, abuse or other factors.
 - b. Products that have been opened, partly used or which the labels or seals have been removed or tampered.
 - c. Products that have been involved in a special promotion sale.
 - d. Broken, damaged or opened cases. Resealed cartons are not eligible for return.
 - e. Special products made to Buyer's specification.
 - f. Sets over two (2) years old, flush syringe products, infusion systems devices, related accessories and IV poles.
5. Products that are to be returned for repair (e.g., medical device equipment) must be accompanied by an approved Repair Notification.

Expiration Date: On dated products, the expiration date is shown as a month and year, e.g., August 2012, 8/12. The date of expiration is the last day of the given month, e.g., August 31, 2012.

Credits for returned goods are conditioned upon B. Braun's inspection and approval of such goods upon their return. If B. Braun determines, in its discretion, that any returned goods are not eligible for return due to any of the reasons provided in paragraph 4 above, Buyer will not receive a credit, even if an Return document was issued. No advance credits will be accepted.

Warranty: With respect to disposable products, B. Braun warrants to the original purchaser that, at time of delivery, each standard product manufactured by B. Braun shall be free of defects in material and workmanship and, when used for the purposes and indications described on the labeling, is fit for the purposes and indications described on the labeling. All warranties for a product shall expire as of product expiration date, or if none, after one (1) year from the date of shipment from B. Braun. B. Braun's warranty hereunder shall not apply if: (i) a product is not used in accordance with its instructions or if it is used for a purpose not indicated on the labeling, (ii) any repairs, alterations or other work has been performed by Buyer or others on such item, other than work performed with B. Braun's authorization and according to its approved procedures; or (iii) the alleged defect is a result of abuse, misuse, improper maintenance, accident or the negligence of any party other than B. Braun. The warranty set forth herein is conditioned upon proper storage, installation, use and maintenance in accordance with applicable written recommendations of B. Braun. The warranty furnished hereunder does not extend to damage to items purchased hereunder resulting in whole or in part from the use of components, accessories, parts or supplies not furnished by B. Braun.

B. Braun's sole obligation shall be to repair or replace, at B. Braun's option, any defective component or item and pay transportation expenses for such replacement. Buyer shall provide labor for the removal of the defective component or item and installation of its replacement at no charge to B. Braun. Buyer shall bear all risk of loss or damage to returned goods while in transit. In the event no defect or breach of warranty is discovered by B. Braun upon receipt of any returned item, the item will be returned to Buyer at Buyer's expense and Buyer will reimburse B. Braun for the transportation charges, labor and associated charges incurred in testing the allegedly defective item.

Except as expressly provided herein, B. Braun makes no representation or warranty of any kind, expressed or implied with respect to any products, parts or services provided by B. Braun including, but not limited to, the implied warranties of merchantability and fitness for a particular purpose. Products distributed, but not manufactured, by B. Braun are not warranted by B. Braun and Buyer must instead rely on the representations and warranties, if any, provided directly to Buyer by the manufacturer of such product. The sole and exclusive remedy for breach of any warranty is limited to the remedies provided in the paragraph above.

Warranties for infusion system devices are provided in a separate warranty document.

Miscellaneous:

1. Any required notices shall be given in writing, in the case of B. Braun, at the address set forth below, and in the case of Buyer, at the address designated on Buyer's purchase order or to such other address as either party may substitute by written notice to the other and shall be deemed given upon personal delivery, overnight delivery or three days following deposit in the mail.
2. Except as expressly provided herein, no changes or modifications to, or waiver of, any of these terms and conditions shall be valid or binding on either party unless in writing and signed by an authorized representative of each party. B. Braun's failure or delay to exercise or enforce any of its rights hereunder shall not constitute or be deemed to be a waiver of such rights or forfeiture of such rights, and B. Braun may, at its option, from time to time, exercise any of its rights or remedies.
3. These Terms bind Buyer and its successors and permitted assigns.
4. B. Braun will use its reasonable efforts to fill orders, but B. Braun shall not be liable for nonperformance or delays caused by a shortage of raw materials, manufacturing problems, delivery or labor problems, priorities, acts of regulatory agencies or judicial bodies, discontinuation of a product line, acts of God or third parties, infringement claims, or other causes beyond its reasonable control. Buyer agrees that in such events B. Braun may allocate products among all purchasers as it deems reasonable, without liability.
B. Braun reserves the right from time to time to substitute a product with a product that has the same function as such product, or to delete a product.
5. The products are sold subject to Pennsylvania law. These terms and any dispute or claim relating to these terms or the sale of products ("Claim") shall be governed by and construed under Pennsylvania law, notwithstanding its law of conflicts of law. If any Claim cannot be settled amicably between the parties, such Claim shall be tried by a court and not a jury. Buyer expressly and unconditionally waives its rights to a jury trial in any such Claim.
6. B. Braun shall promptly deliver written notice or verbal, followed by written, notice of any recall of Product. Should the recall require Products be removed from the market, B. Braun shall, to the extent reasonably possible and at B. Braun's option, replace any such recalled Products as soon as practicable with comparable Products not subject to such recall or repair any such recalled Products and return them to Buyer.
7. Buyer may not change, adulterate, obscure, remove or deface trademarks, tradenames or labels appearing on any Product of B. Braun.
8. If the pricing offered by B. Braun to a Buyer constitutes a discount or other reduction in price under Section 1128(b)(3)(a) of the Social Security Act 42 U.S.C. 1320a-7b(b)(3)(a), and C.F.R. § 1001.952(h), Buyer shall disclose the discount or reduction in price to the fullest extent required under any state or federal program that provides cost or charge-based reimbursement to Buyers for products. This act requires, among other things, that Buyer fully and accurately report on any claim or request for payment it submits to Medicare and Medicaid the actual purchase price paid by Buyer for products, net of any discounts, rebates or allowances provided hereunder. Buyer may also be required, upon request, to provide documentation of the discount or other reduction in price to the Secretary of Health and Human Services.
9. In all cases, all intellectual property rights in and to, and all technology relating to, the Products supplied to Buyer, their design and all improvements thereto or thereof, whether or not such Product, design or improvement is made pursuant to Buyer's specifications or at Buyer's expense, shall be and remain the exclusive property of B. Braun.
10. Any knowledge or information that Buyer may disclose to B. Braun shall not be deemed to be confidential or proprietary information, and shall be acquired by B. Braun free from any restriction.
11. B. Braun shall not in any event be liable to buyer for any indirect, incidental, special, punitive or consequential damages (including any damage for lost profits), or otherwise arising out of or in connection with furnishing of products, parts or service hereunder, or the performance, use of, or inability to use any products, parts or service, or otherwise, whether based in contract, warranty, tort, including without limitation, negligence, or any other legal or equitable theory. B. Braun's total liability for any claim or action shall not exceed the purchase price of the products out of which such claim or action arose.
12. If any of the products are medical devices, Buyer acknowledges that it is familiar with the Safe Medical Devices Act of 1990 (the "Devices Act") and the reporting obligations imposed on device users thereunder. In this regard, Buyer agrees to notify B. Braun within ten (10) days of the occurrence of any event identified in the Devices Act imposing a reporting obligation on Buyer and/or B. Braun (except for events representing an imminent hazard that require notification to the United States Food and Drug Administration (the "FDA") within seventy-two hours, in which case, such notice will be delivered to the other party immediately).

Buyer shall maintain adequate tracking for the products to enable B. Braun to meet the FDA requirements applicable to the tracking of medical devices.

13. Buyer shall purchase the products for its own use only, and shall not resell the products to any other party. Buyer represents it has examined the products and that they are acceptable and clinically suitable for its intended purposes.

Shipping:

1. Freight charges will be prepaid when orders are shipped via a transportation mode and carrier selected by B. Braun. Unless otherwise stated in an agreement, shipment of infusion systems devices will be made F.O.B. Origin.
2. When expedited delivery, specialized service, or alternate transportation modes are requested, or if requests are inconsistent with efficient distribution practices, an additional charge to cover the premium expense will be added to the invoice. Inside deliveries are subject to additional charges based on current common carrier rates or hourly rates. Palletized deliveries are encouraged.
3. Products will be shipped on a scheduled order and delivery basis. Orders shipped outside Buyer's order and delivery schedule may be subject to a handling charge of \$75.00. B. Braun will provide proof of delivery upon request.

Damage or Loss in Transit: Identity of items and extent of damage or loss must be noted on Buyer's copy of delivery document by the agent of the transportation company. If damage is discovered after receipt of shipment, notify the transportation company immediately and request that inspection be made and an inspection report rendered. Buyer must report concealed shortages or damages within palletized shipments to B. Braun Customer Support within 3 business days of delivery or credit will not be allowed. In addition, Buyer must provide B. Braun with a copy of Buyer's claim request accompanied by a delivery receipt or an inspection report upon which the transportation company has properly noted damage or loss, and B. Braun will issue a credit for the loss or damage and file a claim with the carrier. If such information is not received within ten (10) days of delivery, no credit will be issued.

Send copy of carrier freight bill to Customer Support indicating item and quantity damaged or not received.

Count and inspect your freight before carrier departs. Damaged merchandise should not be accepted.

Please forward all information to Attn: Customer Support, B. Braun Medical Inc., 901 Marcon Blvd., Allentown, PA 18109. (800) 227-2862.

For Order Placement: B. Braun welcomes orders either by telephone, fax, mail or electronically. For telephone orders, please call (800) 227-2862. Faxed orders should be sent to: (610) 266-6122. For infusion devices, call (800) 627-7867 or fax (610) 266-2429. In Canada, please call (800) 624-2920 or fax (800) 624-2939. Mail orders should be directed to Attn: Customer Support, B. Braun Medical Inc., 901 Marcon Blvd, Allentown, PA 18109.

Trademarks

Trademarks of B. Braun Medical Inc. and its affiliates:

ADD-PRO	Cytoguard	Injekt	SPACE	ULTRABLOCK
Adimea	DoseCom	Physiolyte	SAFEPORT	ULTRAPORT
Apex	DoseGuard	PIC	Ster-ASSIST	ULTRAPORT zero
AutoCOMPLETE	DoseScan	PinPad	Superset	
B-Smart	EPICAN	QC Tester	Titan XL	
Chemo Dispensing Pin	Flexima	RateGuard	Transofix	
CONTIPLEX	Hyperformer	RED CAP	UniSpike	

Registered trademarks of B. Braun Medical Inc. and its affiliates:

addEASE	Diapact	FreAmine HBC	NephrAmine	PINNACLE	STIMUPLEX
ADDitIV	DISCOFIX	H.E.L.P.	Nutriliplid	Plasmat	TrophAmine
BIG TAB	DoseTrac	HepatAmine	Omnican	PLEXUFIX	ULTRASITE
CAPS	Duosol	Horizon NXT	OMNIFIX	ProcalAmine	VISTA
CARESITE	DUPLEX	HESpan	ONGUARD	Prontosan	WHIN
ClearChoice-DCB	E3	Hyperlyte	Outlook	Rate Flow	
Clip Lock	ESPOCAN	Infusomat	PAB	SAFELINE	
Diacap	EXCEL	Isolyte	PENCAN	SAFSITE	
Diacap a Polysulfone	Filterflow	MICRO PIN	Perfusor	Solcart B	
DiaLines	FILTER STRAW	MINI-SPIKE	PERIFIX	SPIN-LOCK	
Dialog+	FreAmine	MULTI-AD	Physiolyte	SPINOCAN	

BodyGuard, CMExpress and BodyComm and ColorVision are registered trademarks of CME America, LLC.

ChloroPrep and SEPP are registered trademarks of CareFusion 2200, Inc.

DOCit and HubScrub are trademarks of Saxa Medical Solutions.

T-Pak is a registered trademark of Allegiance.

CIV-Flex is a trademark of CIVCO Medical Instruments Company, Inc.

DuraPrep, Steri-Strip and Tegaderm are registered trademarks of 3M.

Medic is a registered trademark of Medisystems Corporation.

Microsoft Access and Windows are registered trademarks of Microsoft Corporation.

Monoject is a registered trademark of Covidien, AG.

NeedleVISE is a registered trademark of Atrion Medical Products, Inc.

OmniPal is a trademark and Patient Pal, Trans-Pal, Versa Pole, and Walk 'N' Roller are registered trademarks of Pryor Products, Inc.

OpSite is a registered trademark of T.J. Smith and Nephew, Ltd.

PeraChek, PERACIDIN and PeraSidual are registered trademarks of Angelini Pharma Inc.

Plastipak, SafetyGlide and Vacutainer are registered trademarks of Becton Dickinson and Co.

SAF-T-POLE is a trademark of American Medical Manufacturing, Inc.

SPROTTE is a registered trademark of Pajunk GmbH.

Statlock is a registered trademark of C.R. Bard, Inc.

Steripick, Locksite, Buttonhole, MasterGuard, FingerShield, SecureClip and Streamline are registered trademarks of NxStage Medical, Inc.

SUPOR is a registered trademark of the Pall Corporation.

Tevadaptor is a registered trademark of Teva Medical Ltd.

Trissel's is a trademark of Lawrence A. Trissel.

Velcro is a registered trademark of Velcro Industries B.V.