



# Surgical Drapes and Ancillary Products

# Together we can make it simple.

You're looking for new ways to make it easier— and we're here to help you:

- 1) Make it simple to choose, order and use the products everyone needs.
- 2) Get the best value, so you can feel confident in your decision.
- 3) Create a consistent, quality experience every time you touch the product.

As an industry-leading manufacturer of surgical drapes,<sup>1</sup> Cardinal Health provides a comprehensive selection of surgical drapes and ancillary products that offers patients and clinicians the protection they want and need.

Our surgical drape options in AAMI Level 3 and 4<sup>2</sup> are engineered to meet industry testing criteria. In addition, you'll find all the features that clinicians prefer, including drapeable fabric and cord management features.



<sup>1</sup>2015 GHX Data

<sup>2</sup>AAMI Levels determined per ANSI/AAMI PB70:2012

# Contents

<b>Surgical drapes and packs .....</b>	<b>4-85</b>
Ancillary.....	5-12
Ancillary patient drapes.....	6-9
Drape accessories.....	9-10
Equipment drapes and covers.....	11-12
Angiography .....	13-18
Cardiovascular .....	19-22
Central Line .....	23-25
Cystoscopy .....	26-27
General surgery.....	28-35
Neurosurgery.....	36-37
Obstetrics .....	38-40
Ophthalmology and EENT.....	41-47
Orthopedics.....	48-59
Heavy-duty.....	49-50
Pacemaker .....	60-63
Pediatrics .....	64-66
Peri-GYN.....	67-71
Special procedures .....	72-74
Standard packs.....	75-93
<b>Indexes.....</b>	<b>94-102</b>
Sterile number index.....	94-96
Nonsterile number index.....	97-99
Product index.....	100-102



# Cardinal Health™ SMS Surgical Drapes have a fresh look

Enhanced drape features include:

- **Royal blue color for SMS drape fabric**
  - Helps reduce glare from operating room lights
  - Provides color contrast between drape fabric and reinforced areas for visual definition of critical zone
- **Standardized absorbent reinforcement material in critical zones**
  - Creates a more consistent look, feel and experience for clinicians
- **Enhanced reinforcement sizing on select codes**
- **Fabric anesthesia screen on select codes**

As always, Cardinal Health makes it a priority to meet industry standards and regulations.

## **Flammability standard**

Woven/nonwoven materials meet the Standard for the Flammability of Clothing Textiles CPSC 16 CFR Part 1610.

## **Latex statement**



Cardinal Health™ Surgical Drapes are not made with natural rubber latex.



Surgical Drapes and Packs

# Ancillary

# Ancillary Patient Drapes

 Basic drape fabric	 Reinforcements	 Side panel material
 Adhesive	 Incise	 Clear plastic panels, anesthesia screens and pouches

Ancillary

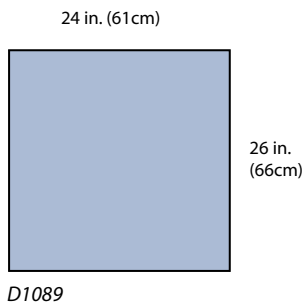
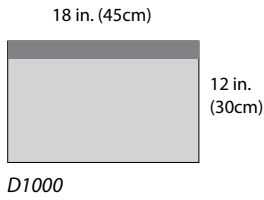

## Drape Towels

Sterile No.	Nonsterile No.	Description	Qty. Pkg	Qty. Cs
7550	8520N	Absorbent towel, white, 15.5 x 22 in. (40 x 56cm)	2	120
7552	N/A	Blue drape towel, non-absorbent, sterile, 15 x 26 in. (38 x 66cm)	2	120
D1089	D1089NS	Utility drape (2 drapes per pkg) 24 x 26 in. (61 x 66cm)	2	20
7553	8554N	Blue drape towel, non-absorbent with adhesive strip, sterile, 15 x 26 in. (38 x 66cm)	2	120
SPP99GSUDA	N/A	Utility drape pack, blue drape towel, nonabsorbent with adhesive strip, sterile, 15 x 26 in. (38 x 66cm)	4	70
7554	7554N	Drape Towel, with adhesive strip, sterile, 19 x 30 in. (48 x 76cm)	2	60
8553	N/A	Fenestrated towel, sterile, 19.25 x 26 in. (49 x 66cm), 2.75 in. aperture, blue	1	120
3523	N/A	Fenestrated poly-lined towel, white absorbent, 18 x 26 in. (45 x 66cm), 2.5 in. aperture, sterile	1	100
3520	N/A	Poly-lined towel, white, absorbent, 18 x 26 in. (45 x 66cm)	1	100
N/A	9460N	Peri-towel, 7.5 x 22 in. (19 x 56cm)	N/A	N/A
N/A	8365N	Set-up cover, 40 x 71 in. (102 x 180cm)	N/A	N/A
D1000	D1000NS	Towel drape 18 x 12 in. (45 x 30cm), Adhesive 18 x 1.5 in. (45 x 3.8cm)	1	10
D1010	D1010NS	Towel drape 18 x 24 in. (45 x 61cm), Adhesive 18 x 1.5 in. (45 x 3.8cm)	1	10

# Surgical Drapes and Packs

## Ancillary Patient Drapes

### Drape Sheets

Sterile No.	Nonsterile No.	Description	Qty. Cs
9358	9358N	Half Sheet, 40 x 57 in. (101 x 145cm)	20
9355	9355N	Medium Sheet, 40 x 71 in. (101 x 180cm)	20
9349	9349N	Three-Quarter Sheet, 52 x 76 in. (132 x 193cm)	20
TB9349CE	TB9349NI	Three-Quarter Sheet, absorbent, 60 x 76 in. (152 x 193cm)	20
29350	29350N	Three-Quarter Sheet, 56 x 77 in. (142 x 195cm), with absorbent reinforcement, 25 x 42 in. (63 x 106cm)	20
9446	9446N	Large Sheet, 72 x 85 in. (183 x 216cm)	30
9444	9444N	X-Large Sheet, 77 x 98 in. (195 x 249cm)	12
9462	9462N	Utility Drape Sheet, 44 x 60 in. (112 x 152cm), 4 x 6 in. (10 x 15cm) poly-reinforced fenestration	20
N/A	8470N	Plastic setup cover, 50 x 59 in. (127 x 150cm)	N/A
N/A	8750	Prep pad, absorbent, 9 in. cuff, 24 x 41 in. (61 x 104cm), nonsterile	50

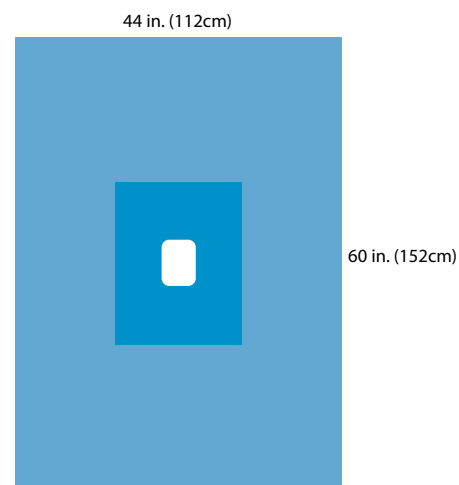

9462 Utility Drape Sheet

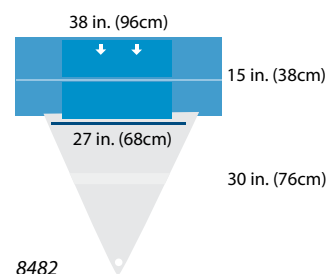

8482

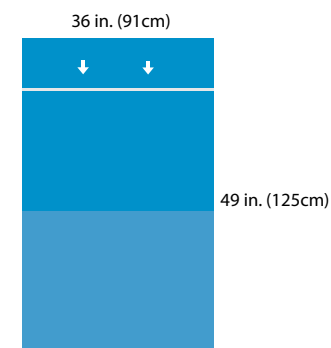

8483

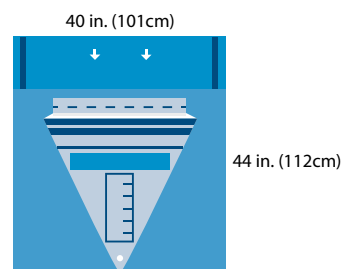

8487

### Drape Sheet, Square-Folded

Sterile No.	Nonsterile No.	Description	Qty. Cs
9461	9461N	Drape Sheet, square-folded, 38.5 x 38.5 in. (98 x 98cm)	30

### Drape Sheets with Adhesive

Sterile No.	Nonsterile No.	Description	Qty. Cs
M9471	N/A	Drape Sheet with adhesive, 38.5 x 38.5 in. (98 x 98cm)	30
9464	N/A	Three-Quarter Sheet with adhesive, 60 x 76 in. (152 x 193cm)	26

### Under-Buttocks Drapes

Sterile No.	Nonsterile No.	Description	Qty. Cs
8482	8482N	Under-buttocks drape, with fluid control pouch, filtering screen, drainage port and reinforcement	20
8483	8483N	Under-buttocks drape, reinforced poly, 9 in. cuff, 36 x 49 in. (91 x 125cm)	40
8484	8484N	Under-buttocks drape with fluid control pouch, reinforcement	20
8486	8486N	Under-buttocks drape, fluid control pouch with filtering screen and drainage port, plastic backing	20
8461	8461N	Under-buttocks drape, fluid control pouch with filtering screen and drainage port, plastic backing with reinforcement on cuff	20
8487	8487N	Under-buttocks drape with graduations, fluid control pouch with filtering screen and drainage port, plastic backing	20

# Ancillary Patient Drapes

 Basic drape fabric	 Reinforcements	 Side panel material
 Adhesive	 Incise	 Clear plastic panels, anesthesia screens and pouches

Ancillary

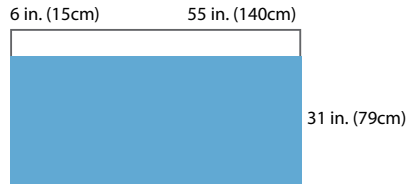

8430

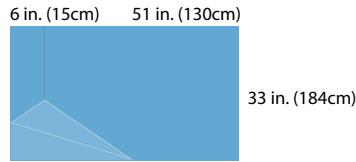

8433



1585

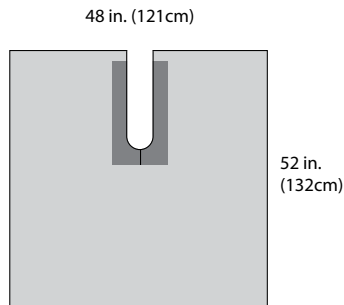

D1015

## Leggings

Sterile No.	Nonsterile No.	Description	Qty. Cs
8420	8420NA	Leggings, folded, 6 in. cuff, 28 x 43 in. (71 x 109cm), 2/pkg.	20
8421	8421N	Leggings, folded, 6 in. cuff, 31 x 48 in. (79 x 123cm), 2/pkg.	20
8430	8430NA	Clear leggings, folded, 6 in. cuff, 31 x 55 in. (79 x 140cm), 2/pkg	20
8433	8433N	Extra large leggings, folded, 6 in. cuff, 33 x 51 in. (84 x 130cm), 2/pkg.	20

## Stockinettes

Sterile No.	Nonsterile No.	Description	Size	Qty. Cs
1584	N/A	Stockinette, small	6 x 30 in. (15 x 76cm)	30
1585	1585N	Stockinette, medium	8 x 38 in. (20 x 96cm)	30
1586	1586N	Stockinette, large	9 x 48 in. (23 x 122cm)	40
1587	1582N	Stockinette, X-large	12 x 48 in. (31 x 122cm)	40

## Poly U-Drapes

Sterile No.	Nonsterile No.	Description	Size	Qty. Cs
8474	8474N	Blue poly U-drape, 6 x 21 in. split with adhesive	60 x 60 in. (152 x 152cm)	28
8475	8475N	Blue poly U-drape, 8 x 30 in. split with adhesive	60 x 84 in. (152 x 213cm)	22
8476	8476NA	Blue poly U-drape, 6 x 21 in. split with adhesive	60 x 72 in. (152 x 183cm)	24
D1015	D1015NS	Clear poly U-drape, Adhesive 9.5 x 19.5 in. (24 x 50cm), split 6 x 19 in. (15 x 48cm)	48 x 52 in. (121 x 132cm)	10
D1019	D1019NS	Clear poly U-drape, Adhesive 9.5 x 19.5 in. (24 x 50cm), Adhesive tab 3 x 1 in. (7 x 2.5cm), split 6 x 19 in. (15 x 48cm)	48 x 71 in. (121 x 180cm)	10



# Surgical Drapes and Packs

## Ancillary Patient Drapes

### Wound Protectors

Sterile No.	Nonsterile No.	Description	Qty. Cs
D37612210	N/A	Wound protector 35 x 35 in. (90 x 90cm), Ring 3 in. dia. (7cm dia.), Adhesive tabs (4) 2 x 2 in. (5 x 5cm)	40
D37106310	N/A	Wound protector 35 x 35 in. (90 x 90cm), Ring 9 in. dia. (23cm dia.), Adhesive tabs (4) 2 x 2 in. (5 x 5cm)	40
D37106210	N/A	Wound protector 35 x 35 in. (90 x 90cm), Ring 5 in. dia. (12cm dia.), Adhesive tabs (4) 2 x 2 in. (5 x 5cm)	40
D37106410	N/A	Wound protector 35 x 35 in. (90 x 90cm), Ring 11 in. dia. (28cm dia.), Adhesive tabs (4) 2 x 2 in. (5 x 5cm)	40
D37104910	N/A	Wound protector 35 x 35 in. (90 x 90cm), Ring 7 in. dia. (18cm dia.), Adhesive tabs (4) 2 x 2 in. (5 x 5cm)	40

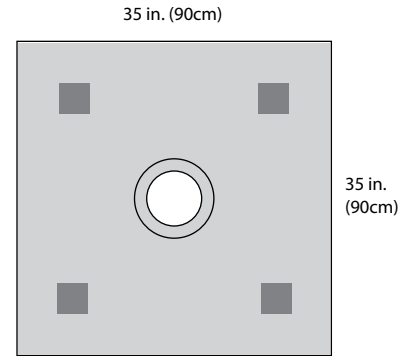

D37612210

### Adhesives and Drape Tape

Sterile No.	Nonsterile No.	Description	Qty. Cs
D2029	D2029NS	Tape strip 3.5 x 24 in. (9 x 61cm), Adhesive area 3.5 x 23.5 in. (9 x 60cm)	10
3524	N/A	Drape tape, 4 x 18.5 in. (10 x 47cm)	2

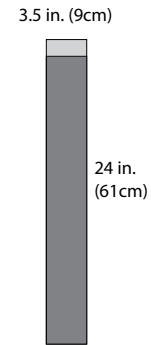

D2029

### Pouches

Sterile No.	Nonsterile No.	Description	Qty. Cs
D1018	D1018NS	Instrument pouch 6.75 x 11.5 in. (17 x 29cm), Adhesive (2) 6.75 x 2 in. (17 x 5cm)	10
D1018L	D1018LNS	Instrument pouch 10 x 18 in. (26 x 45cm), Adhesive (2) 10 x 2 in. (26 x 5cm)	10

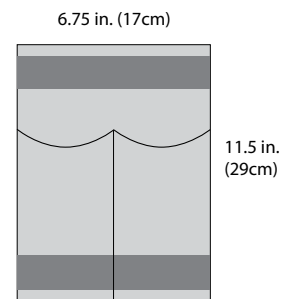

D1018

# Drape Accessories

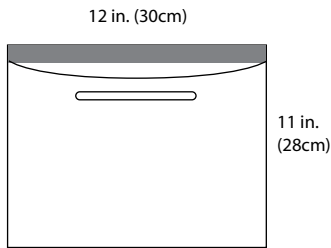

D2114

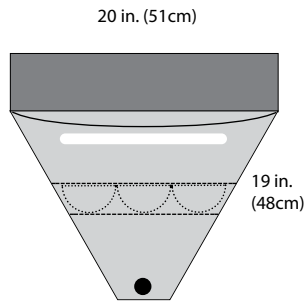

D1016

## Pouches

Sterile No.	Nonsterile No.	Description	Qty. Cs
D2021	D2021NS	Irrigation pouch 8.5 x 11 in. (21 x 28cm), Adhesive 8.5 x 1 in. (21 x 2.5cm)	10
D2114	D2114NS	Irrigation pouch 12 x 11 in. (30 x 28cm), Adhesive 12 x 1 in. (30 x 2.5cm)	10
C2326*	C2326NS*	Irrigation pouch 30 x 11 in. (76 x 28cm), Adhesive 30 x 1 in. (76 x 2.5cm)	10
D1016	D1016NS	Fluid pouch 20 x 19 in. (51 x 48cm), Adhesive 20 x 3.75 in. (50 x 9cm)	10
D1072	D1072NS	Aperture pouch 18 x 9 in. (45 x 22cm), Aperture 4.75 x 3.75 in. (12 x 9cm), Adhesive (9.5 x 9 in.)	10

\* Denotes a 6-8 week lead time

## Isolation Bags

Sterile No.	Nonsterile No.	Description	Qty. Cs
D5510	D5510NS	Isolation bag 18 x 18 in. (45 x 45cm)	40
D1003	D1003NS	Isolation bag 20 x 20 in. (51 x 51 cm)	10

# Equipment Drapes and Covers

## Standard Back Tables Covers

Sterile No.	Nonsterile No.	Description	Qty. Cs
8376	8145N	Standard back table cover, 44 x 75 in. (112 x 190cm), SMS reinforcement, 23 x 75 in. (58 x 190cm)	22
8377	8146N	Standard back table cover, 44 x 90 in. (112 x 228cm), SMS reinforcement, 23 x 90 in. (58 x 228cm)	22
8378	8184N	Standard back table cover, 50 x 90 in. (127 x 228cm), SMS reinforcement, 29 x 90 in. (73 x 228cm)	24
8380	8187N	Standard back table cover, 80 x 90 in. (203 x 228cm), SMS reinforcement, 40 x 90 in. (102 x 228cm)	22
N/A	8371NI	Standard back table cover, 55 x 75 in. (140 x 190cm), SMS reinforcement 29 x 75 in. (73 x 190cm)	N/A
N/A	8191N	Standard back table cover, 50 x 47 in. (127 x 119cm), SMS reinforcement, 30 x 47 in. (76 x 119cm)	N/A
9385	8188N	Overhead table cover, 80 x 90 in. (203 x 228cm), reinforced poly with 44 x 72 in. (112 x 183cm) fabric sterile field extension, SMS reinforcement, 40 x 90 in. (101 x 228cm)	12
8145W	8145NW	Standard back table cover for ophthalmic procedures, 44 x 75 in. (112 x 190cm), cellulose reinforcement, 23 x 75 in. (58 x 190cm)	22
8146W	8146NW	Standard back table cover for ophthalmic procedures, 44 x 90 in. (112 x 229cm), cellulose reinforcement, 23 x 90 in. (58 x 229cm)	22
N/A	8184NW	Standard back table cover for ophthalmic procedures, 50 x 90 in. (127 x 229cm), cellulose reinforcement, 29 x 90 in. (74 x 229cm)	N/A

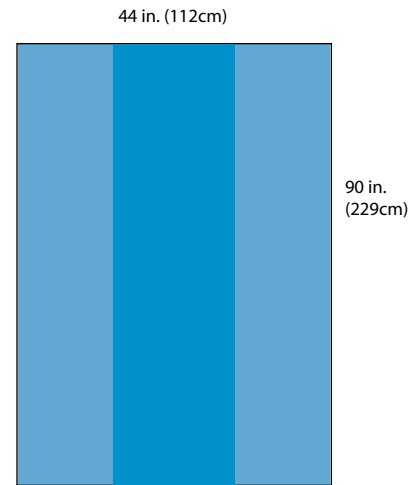

Ancillary

## Heavy-Duty Back Table Covers

Sterile No.	Nonsterile No.	Description	Qty. Cs
8186	8186N	Heavy-duty back table cover, 60 x 90 in. (152 x 229cm), thick SMS reinforcement, 29 x 90 in. (74 x 229cm)	24
8186W	8186NW	Heavy-duty back table cover for ophthalmic procedures, 65 x 90 in. (165 x 229cm), cellulose reinforcement, 29 x 90 in. (74 x 229cm)	24
8386	8153N	Extra heavy-duty back table cover, 65 x 90 in. (165 x 229cm), thick SMS reinforcement, 28 x 90 in. (71 x 229cm)	12
8385	8152N	Extra heavy-duty back table cover, 80 x 110 in. (203 x 279cm), thick SMS reinforcement, 37 x 110 in. (94 x 279cm)	10

# Equipment Drapes and Covers

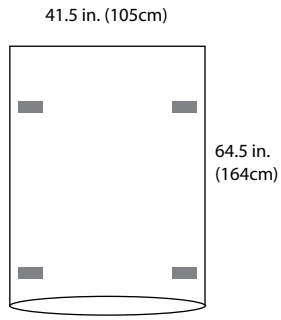

D1013

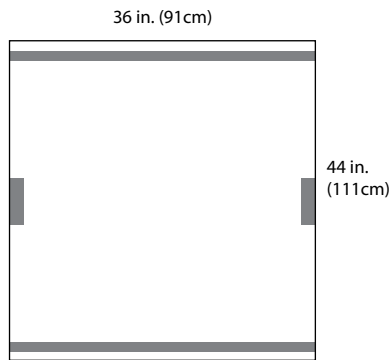

D1012

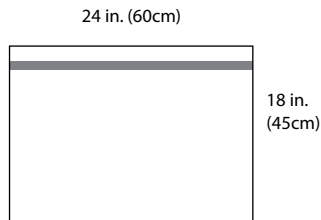

D2158

## Mayo Stand Covers

Sterile No.	Nonsterile No.	Description	Qty. Cs
8337	8337N	Mayo stand cover, reinforced poly, 23 x 55 in. (58 x 140cm)	30
8339	8339NI	Mayo stand cover, reinforced poly, 29.5 x 55 in. (75 x 140cm)	22

## Equipment Covers

Sterile No.	Nonsterile No.	Description	Qty. Cs
D1013	D1013NS	C-Arm Cover 41.5 x 64.5 in. (105 x 164cm), Adhesive (4) 1 x 3 in. (2.5 x 8cm)	10
D1012	D1012NS	Fluoroscope Cover 36 x 44 in. (91 x 111cm), Adhesive strips 36 x 0.5 in. (91 x 1.2cm), Adhesive tabs 2.5 x 4.25 in. (6 x 11cm)	10
D2158	D2158NS	Instrument Cover 24 x 18 in. (60 x 45cm), Adhesive 24 x 0.5 in. (60 x 1.2cm)	10
D2007	D2007NS	Clear Cover 36 x 44 in. (91 x 111cm)	30
D2008A	D2008NS	Clear Cover 44 x 72 in. (111 x 182cm)	25

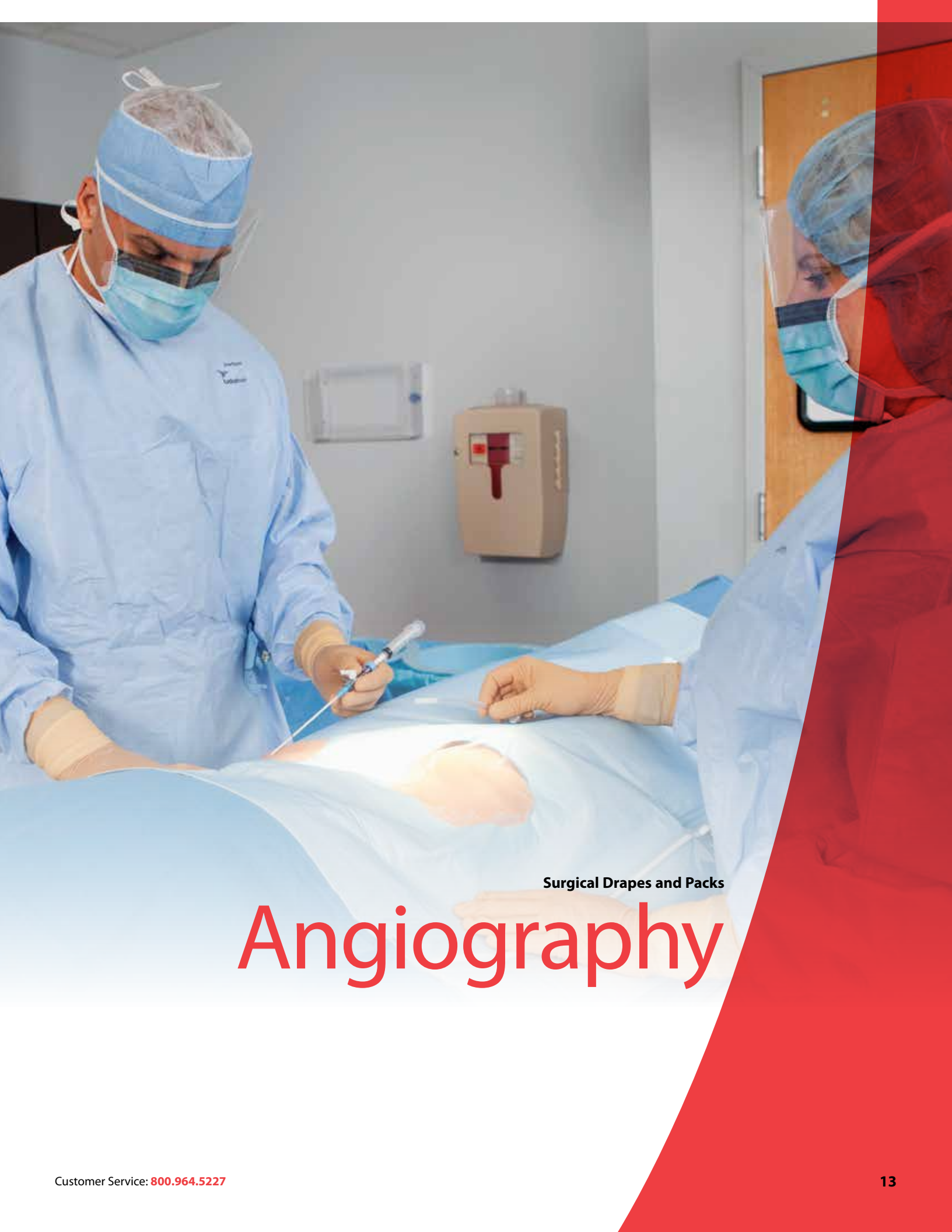

Surgical Drapes and Packs

# Angiography

# Angiography

 Basic drape fabric	 Reinforcements	 Side panel material
 Adhesive	 Incise	 Clear plastic panels, anesthesia screens and pouches

Angiography

## Femoral Angiography Drape with Catheter Pouch

Sterile No.	Nonsterile No.	Qty. Cs
29459	29459N	16

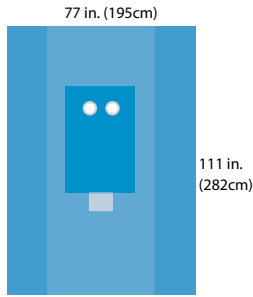

- Absorbent reinforcement, 28.75 x 44 in. (73 x 112cm)
- Fenestration, dual circular, 6 in. (15cm), with circular incise aperture, 3.5 in. (9cm)
- Catheter pouch, 8.5 x 11.5 in. (21.5 x 29cm)

## Femoral Angiography Drape

Sterile No.	Nonsterile No.	Qty. Cs
29456	29456N	14

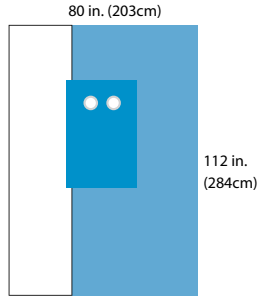

- Absorbent reinforcement, 28.75 x 44 in. (73 x 112cm)
- Fenestration, dual circular, 6 in. (15cm), with circular incise aperture, 3.5 in. (9cm)
- Single clear side panel on patient's right side

## Femoral Angiography Drape

Sterile No.	Nonsterile No.	Qty. Cs
29460	29460N	16

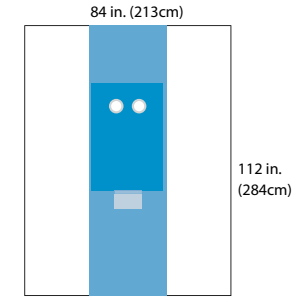

- Absorbent reinforcement, 28.75 x 44 in. (73 x 112cm)
- Fenestration, dual circular, 6 in. (15cm), with circular incise aperture, 3.5 in. (9cm)
- Catheter pouch, 8.5 x 11.5 in. (21 x 29cm)
- Clear side panels

## Angiography Sheet

Sterile No.	Nonsterile No.	Qty. Cs
D1195	D1195NS	20

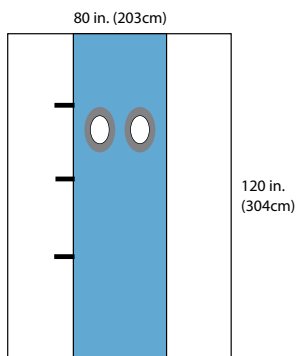

- Absorbent central panel, 29 x 120 in. (74 x 304cm)
- Apertures: 3.5 x 4.5 in. (9 x 11cm)
- Clear side panels
- Malleable bars on right panel

## Femoral Angiography Drape

Sterile No.	Nonsterile No.	Qty. Cs
29520	29520N	16

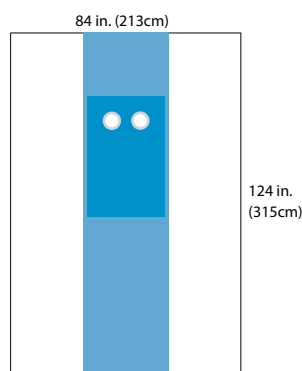

- Absorbent reinforcement, 28.75 x 44 in. (73 x 112cm)
- Fenestration, dual circular, 6 in. (15cm), with circular incise aperture, 3.5 in. (9cm)
- Clear side panels

## Angiography Sheet

Sterile No.	Nonsterile No.	Qty. Cs
N/A	D1495NS	N/A

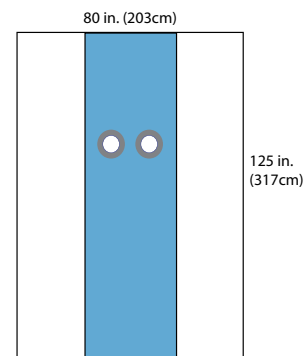

- Absorbent central panel, 29 x 125 in. (74 x 317cm)
- Apertures: 3.5 in. dia. (9cm dia.)
- Clear side panels

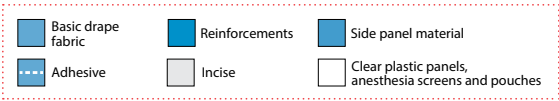

**Femoral Angiography Drape with Expanded Reinforcement**

Sterile No.	Nonsterile No.	Qty. Cs
29556	29556NA	8

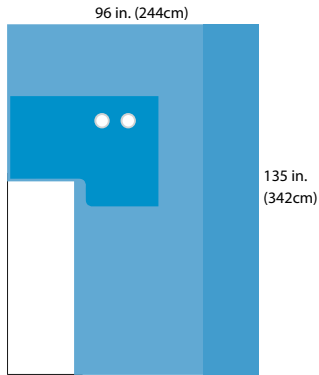

- Absorbent reinforcement, 28.75 x 44 in. (73 x 112cm) fenestrated area; 28.75 x 32 in. (73 x 81 cm) above clear panel
- Fenestration, dual circular, 6 in. (15cm), with circular incise aperture, 3.5 in. (9cm)
- Single clear side panel on patient's right side

**Angiography Sheet**

Sterile No.	Nonsterile No.	Qty. Cs
D2244	D2244NS	20

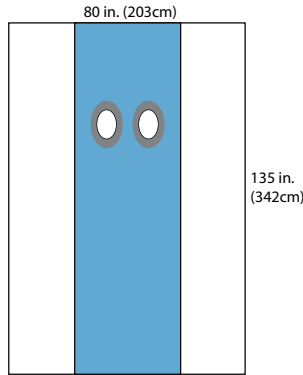

- Absorbent central panel, 29 x 135 in. (74 x 342cm)
- Apertures: 3.5 x 4.5 in. (9 x 11cm)
- Clear side panels

**Angiography Sheet**

Sterile No.	Nonsterile No.	Qty. Cs
D2286	D2286NS	20

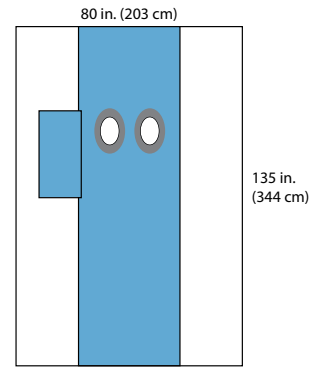

- Absorbent central panel, 29 x 135 in. (74 x 342cm)
- Additional absorbent pad: 14.5 x 33 in. (36 x 84cm)
- Apertures: 3.5 x 4.5 in. (9 x 11cm)
- Clear side panels

**Femoral Angiography Drape with Trough**

Sterile No.	Nonsterile No.	Qty. Cs
29560	29560N	8

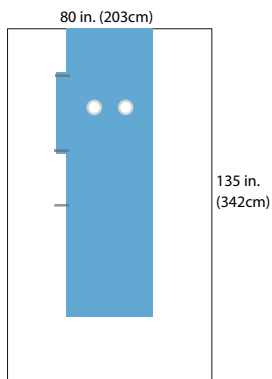

- Absorbent reinforcement, 33.5 x 111 in. (85 x 282cm)
- Fenestration, dual circular, 6 in. (15cm), with circular incise aperture, 3.5 in. (9cm)
- Clear side panels
- Clear foot panel
- Malleable bars with 4 x 32 in. (108 x 81cm) trough

**Angiography Sheet**

Sterile No.	Nonsterile No.	Qty. Cs
N/A	D2294NSC	N/A

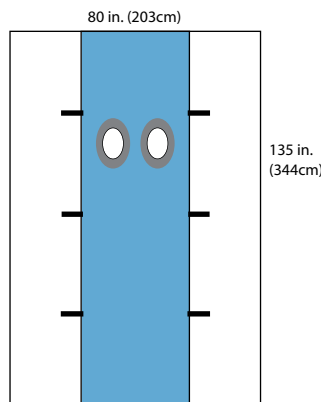

- Absorbent central panel, 29 x 135 in. (74 x 342cm)
- Apertures: 3.5 x 4.5 in. (9 x 11cm)
- Clear side panels
- Malleable bars on right and left panels

**Femoral Angiography Drape with Single Pouch**

Sterile No.	Nonsterile No.	Qty. Cs
29525	29525N	10

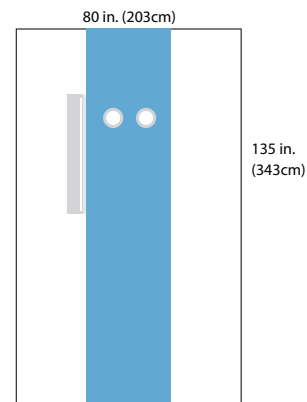

- Absorbent reinforcement, 36 x 135 in. (91 x 343cm)
- Fenestration, dual circular, 6 in. (15cm), with circular incise aperture, 3.5 in. (9cm)
- Clear side panels
- Clear pouch on patient right side, 6 x 44 in. (15 x 112cm)

# Angiography

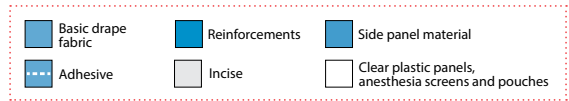

## Angiography Sheet

Sterile No.	Nonsterile No.	Qty. Cs
D2288C	D2288NSC	20

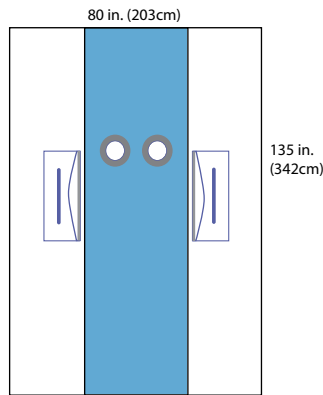

- Absorbent central panel, 29 x 135 in. (74 x 342cm)
- Aperture: 3.5 in. dia. (9cm dia.)
- Clear side panels
- Dual side pouches: 11 x 30 in. (28 x 76cm)

## Femoral Angiography Drape with Dual Pouches

Sterile No.	Nonsterile No.	Qty. Cs
29521	29521N	10

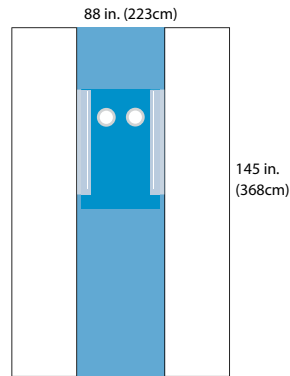

- Absorbent reinforcement, 32 x 50 in. (81 x 127cm)
- Fenestration, dual circular, 6 in. (15cm), with circular incise aperture, 3.5 in. (9cm)
- Clear side panels
- Clear pouches on patient left and right side

## Angiography Sheet

Sterile No.	Nonsterile No.	Qty. Cs
N/A	D2265NSC	N/A

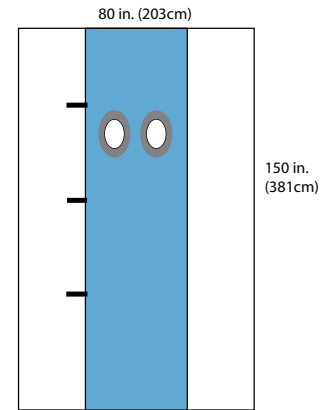

- Absorbent central panel, 29 x 150 in. (74 x 381cm)
- Apertures: 3.5 x 4.5 in. (9 x 11cm)
- Clear side panels
- Malleable bars on right panel

## Extra Large Femoral Angiography Drape

Sterile No.	Nonsterile No.	Qty. Cs
29570	29570N	8

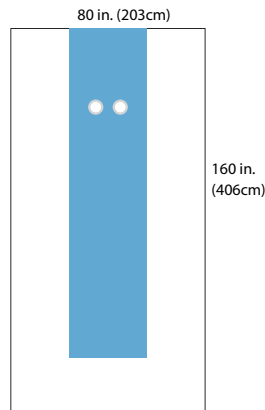

- Absorbent reinforcement, 33.5 x 135 in. (85 x 343cm)
- Fenestration, dual circular, 6 in. (15cm), with circular incise aperture, 3.5 in. (9cm)
- Clear side panels
- Clear foot panel





### Brachial Angiography Drape

Sterile No.	Nonsterile No.	Qty. Cs
29458	29458N	40

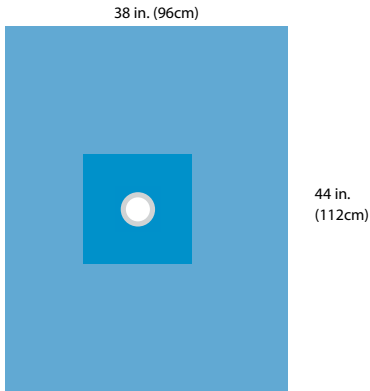

- Absorbent reinforcement, 18 x 20 in. (46 x 51 cm)
- Fenestration, circular incise aperture, 4 in. (10cm)

### Radial/Brachial Drape

Sterile No.	Nonsterile No.	Qty. Cs
D2364	N/A	20

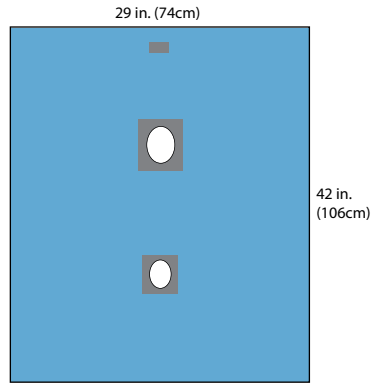

- Absorbent drape material
- Radial aperture: 2 x 3 in. (5 x 7.6cm)
- Brachial aperture: 2.5 x 3.5 in. (6 x 9cm)
- Adhesive tab: 2 x 1 in. (5 x 2.5cm)

### Radial/Brachial Drape

Sterile No.	Nonsterile No.	Qty. Cs
D2422	N/A	20

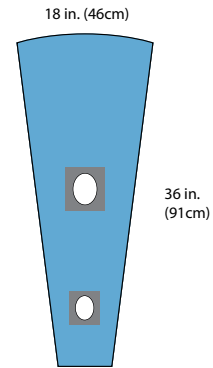

- Absorbent drape material
- Radial aperture: 2 x 3 in. (5 x 7.6cm)
- Brachial aperture: 2.5 x 3.5 in. (6 x 9cm)

### Brachial Angiography Drape

Sterile No.	Nonsterile No.	Qty. Cs
29461	N/A	10

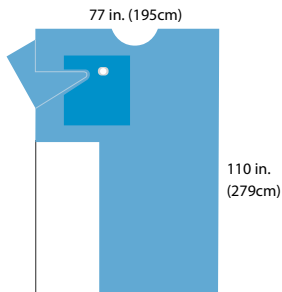

- Absorbent reinforcement, 28 x 29 in. (71 x 73cm)
- Fenestration, oval with aperture incise, 4.5 x 3.5 in. (11 x 9cm)
- Clear side panel on patient's right side
- Armboard cover on patient's right side only
- Clipping tabs by fenestration

# Angiography

Basic drape fabric	Reinforcements	Side panel material
Adhesive	Incise	Clear plastic panels, anesthesia screens and pouches

Angiography

## Radial/Femoral Angiography Drape

Sterile No.	Nonsterile No.	Qty. Cs
29529	29529N	12

- Absorbent reinforcement
- Fenestration, dual circular, 6 in. (15cm), with circular incise aperture, 3.5 in. (9cm)
- Radial access on patient right, 2 x 3 in. (5 x 7.5cm) oval incise aperture
- Clear side and foot panels
- Malleable bars

## Radial/Femoral Angiography Sheet

Sterile No.	Nonsterile No.	Qty. Cs
N/A	C2433NS	20

- Absorbent central panel, 29 x 150 in. (74 x 381cm)
- Absorbent radial reinforcement
- Femoral apertures 3.5 in. x 4.5 in. (8 cm x 11 cm)
- Radial aperture 2.5 in. x 3.5 in. (6 cm x 9 cm)
- Clear side panels

## Moveable Radial/Femoral Angio Sheet

Sterile No.	Nonsterile No.	Qty. Cs
D2399	D2399NS	20

- Absorbent central panel, 29 x 135 in. (74 x 342cm)
- Absorbent reinforcement on moveable radial extension
- Femoral apertures: 3.5 x 4.5 in. (9 x 11cm)
- Radial aperture: 2.5 x 3.5 in. (6 x 9cm)
- Clear side panels

## Lulu Radial/Femoral Angio Sheet

Sterile No.	Nonsterile No.	Qty. Cs
D2344	D2344NS	20

- Absorbent central panel, 29 x 135 in. (74 x 342cm)
- Radial width: 88.75 in. (225cm)
- Femoral apertures: 3.5 x 4.5 in. (9 x 11cm)
- Radial apertures: 2.5 x 3.5 in. (6 x 9cm)
- Clear side panels

## Lulu Radial/Femoral Angio Sheet

Sterile No.	Nonsterile No.	Qty. Cs
D2366	D2366NS	20

- Absorbent central panel, 29 x 135 in. (74 x 342cm)
- Radial width: 88.75 in. (225cm)
- Radial aperture: 2.5 x 3.5 in. (6 x 9cm)
- Femoral apertures: 3.5 x 4.5 in. (9 x 11cm)
- Clear side panels

## Orlando Radial/Femoral Angio Sheet

Sterile No.	Nonsterile No.	Qty. Cs
D2355	D2355NS	20

- Absorbent central panel, 29 x 135 in. (74 x 342cm)
- Additional absorbent pads on right and left side
- Radial width: 86 in. (218cm)
- Femoral apertures: 3.5 x 4.5 in. (9 x 11cm)
- Radial apertures: 2.5 x 6 in. (6 x 15cm)
- Clear side panels

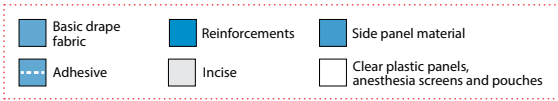

**Multiaccess IR Sheet**

Sterile No.	Nonsterile No.	Qty. Cs
C2411*	C2411NS	20

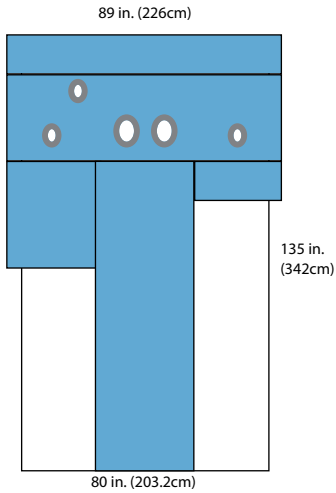

- Absorbent central panel, 29 x 135 in. (74 x 342cm)
- Femoral apertures: 3.5 x 4.5 in. (9 x 11cm)
- Radial apertures: 2.5 x 3.5 in. (6 x 9cm)
- Brachial aperture: 2.5 x 3.5 in. (6 x 9cm)
- Clear side panels

**Moveable Multiaccess IR Sheet**

Sterile No.	Nonsterile No.	Qty. Cs
C2444*	N/A	20

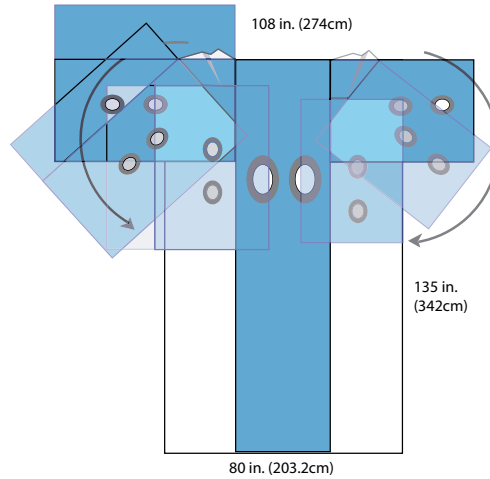

- Absorbent central panel, 29 x 135 in. (74 x 342cm)
- Femoral apertures: 3.5 x 4.5 in. (9 x 11cm)
- Radial apertures: 2.5 x 3.5 in. (6 x 9cm)
- Brachial aperture: 2.5 x 3.5 in. (6 x 9cm)
- Clear side panels

**Pediatric Angiography Sheet**

Sterile No.	Nonsterile No.	Qty. Cs
C2339	N/A	20

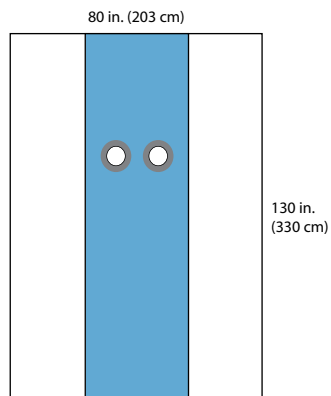

- Absorbent central panel, 29 x 135 in. (74 x 342cm)
- Apertures: 3.5 in. dia. (8 cm dia.)
- Close-set apertures to accommodate smaller patient size
- Clear side panels

**Neonatal Angio Sheet**

Sterile No.	Nonsterile No.	Qty. Cs
D1093	N/A	20

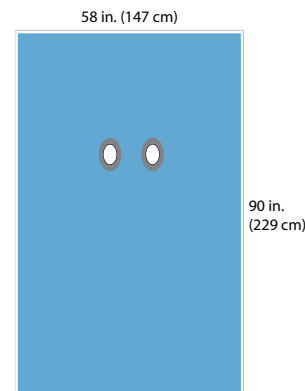

- Absorbent drape material
- Apertures: 1.5 x 2 in. (3 x 5 cm)
- Close-set apertures to accommodate smaller patient size

**Pediatric/Neonatal Angio Drape**

Sterile No.	Nonsterile No.	Qty. Cs
C2242*	N/A	20

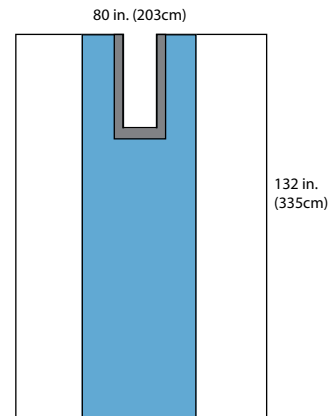

- Absorbent central panel, 29 x 132 in. (74 x 335cm)
- Aperture: 4 x 35 in. (10 x 89cm) with adhesive
- Clear side panels



Surgical Drapes and Packs

# Cardiovascular



**Cardiovascular Split Drape with Troughs**

Sterile No.	Nonsterile No.	Qty. Cs
9158	9158N	8

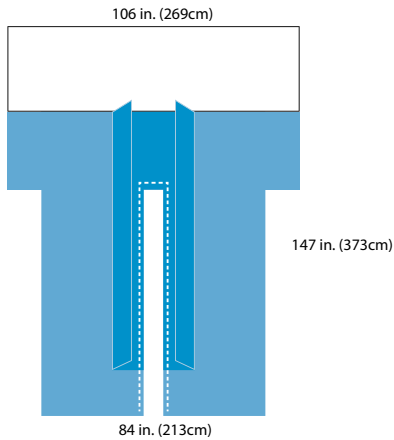

- Absorbent reinforcement
- Split with adhesive, 7 x 88 in. (18 x 223cm)
- Armboard covers
- Clear anesthesia screen
- Instrument trough
- Included in pack 29158

**Cardiovascular Split Drape with Pouches**

Sterile No.	Nonsterile No.	Qty. Cs
9155	9155N	12

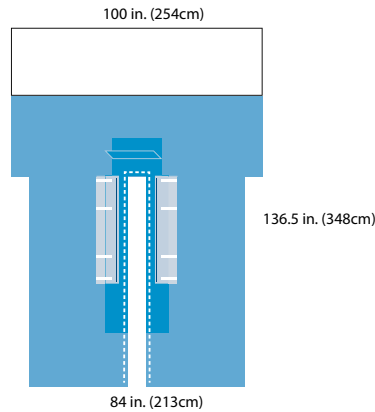

- Absorbent reinforcement, 10 x 57.5 in. (25.4 x 146cm) (sides) and 20 x 15 in. (51 x 38cm) (top)
- Split with adhesive, 7 x 81 in. (18 x 206cm)
- Armboard covers
- Clear anesthesia screen
- Clear pouches on patient right and left
- Clipping tab

**Cardiovascular Split Drape**

Sterile No.	Nonsterile No.	Qty. Cs
29154	29154N	8

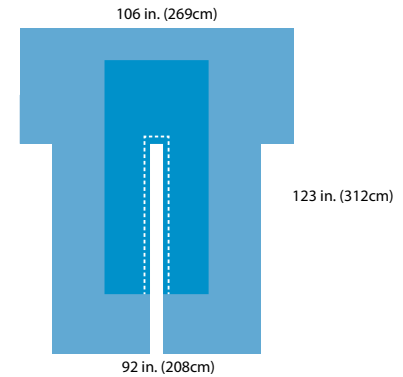

- Absorbent reinforcement
- Split with adhesive, 5 x 80 in. (13 x 203cm)
- Armboard covers

**Cardiovascular Peri-Groin Drape**

Sterile No.	Nonsterile No.	Qty. Cs
9154	9154N	10

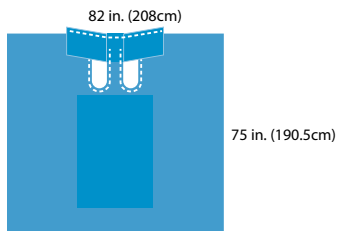

- Absorbent reinforcement, 30 x 42 in. (76 x 106cm)
- Splits, dual with adhesive, 6 x 20 in. (15 x 51cm)
- Attached groin sheet, 36 x 11 in. (91 x 28cm)
- Included in pack 29158

**Cardiovascular Incise Drape**

Sterile No.	Nonsterile No.	Qty. Cs
9156	9156N	7

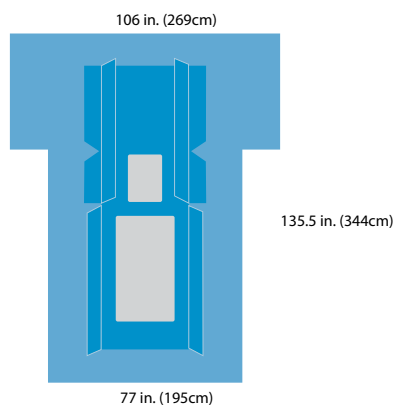

- Non-absorbent reinforcement
- Fenestration, chest incise, 18 x 22 in. (46 x 56cm)
- Fenestration, leg incise, 28 x 45 in. (71 x 114cm)
- Armboard covers
- Clipping tabs

**Cardiovascular Incise Drape**

Sterile No.	Nonsterile No.	Qty. Cs
9162	9162N	7

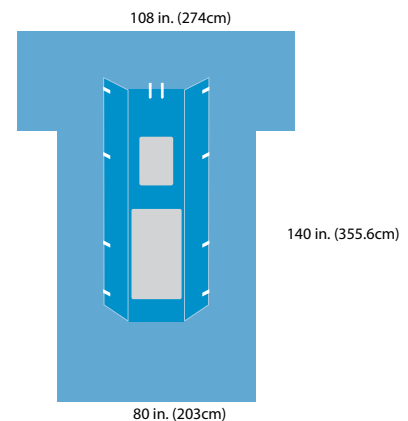

- Absorbent reinforcement, 42 x 88 in. (107 x 223cm)
- Fenestration, chest incise, 14 x 18 in. (25.5 x 46cm)
- Fenestration, leg incise, 24 x 41 in. (61 x 104cm)
- Armboard covers
- Instrument troughs, 8 x 88 in. (20 x 223cm)
- Velcro® Tabs

Surgical Drapes and Packs

# Cardiovascular



Cardiovascular

## Cardiovascular Drape

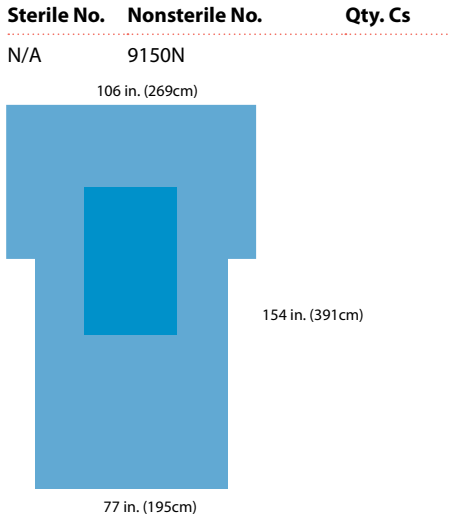

- Absorbent foam reinforcement, 38.5 x 60 in. (98 x 152cm)
- Non-fenestrated
- Armboard covers
- Included in pack 9150

## Head, Side and Foot Drapes

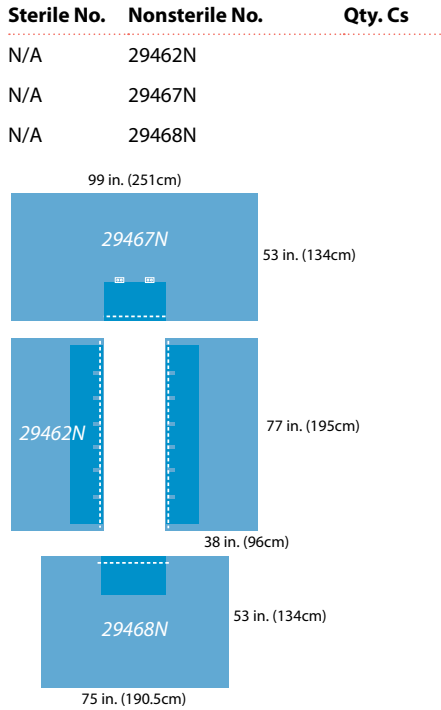

- Absorbent reinforcement
- Cord-holding tabs
- Included in pack 29153

## Bottom Drape with Reinforcement

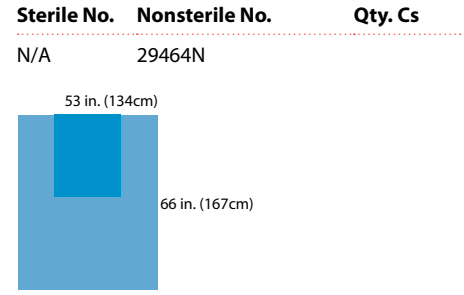

- Absorbent reinforcement, 26 x 30 in. (66 x 76cm)

## CV Universal Drape Pack

Sterile No.	Nonsterile No.	Qty. Cs
9153	9153N TB29667N 29663N TB29669N	5

- Absorbent troughs on side sheets with Velcro® closures
- Velcro® cord-holding tabs on head and foot sheet

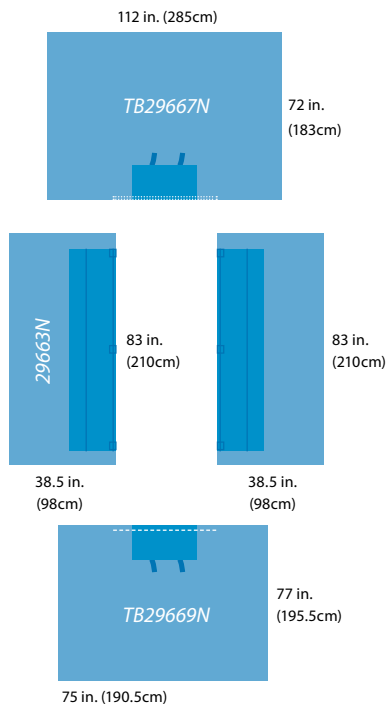

Surgical Drapes and Packs  
**Cardiovascular**

Cardiovascular Packs

Nonsterile No.	Description	9150 Cardiovascular Pack	9153 Cardiovascular Universal Pack	29153 Cardiovascular Pack with reinforced Gowns	29158 Cardiovascular Split Pack II
9150N	Cardiovascular Drape	1			
29467N	Head Drape, 99 x 53 in. (251 x 134.6cm), adhesive, absorbent reinforcement			1	
29462N	Side Drape, 38 x 77 in. (96 x 195cm), adhesive, absorbent reinforcement			2	
29468N	Foot Sheet, 75 x 53 in. (190 x 134.6cm), adhesive, absorbent reinforcement			1	
9349N	Three-Quarter Drape Sheet, 52 x 76 in. (132 x 193cm)	1			1
TB29667N	Head Drape, 112 x 72 in. (285 x 183cm), adhesive, absorbent reinforcement		1		
29663N	Side Sheet, 38.5 x 83 in. (98 x 210cm) with absorbent troughs and Velcro® Closures		2		
TB29669N	Foot Drape, 75 x 77 in. (190.5 x 195.5cm), adhesive, absorbent reinforcement		1		
9154N	Cardiovascular Peri-Groin Drape				1
9158N	Cardiovascular Split Drape II				1
29464N	Bottom Drape with reinforcement			1	
9541N	AAMI 3 Fabric Reinforced Surgical Gown, X-Large	3			
9040N	AAMI 4 Poly Reinforced Surgical Gown, X-Large			2	2
90780N	AAMI 4 Poly Reinforced Scrub Nurse Gown, Xlarge, with towel and wrap			1	
90680NA	AAMI 4 Poly Reinforced Scrub Nurse Gown, Large				1
8520N	Absorbent towel	2		1	
7554N	Drape Towel, with adhesive strip, 19 x 30 in. (48 x 76cm)				8
8694-60	Suture bag	1		1	1
8337N	Mayo stand cover, reinforced poly, 23 x 55 in. (58 x 140cm)	1			1
8188N	Overhead table cover, 80 x 90 in. (203 x 228.6cm), reinforced poly with a 44 x 72 in. (112 x 183cm) fabric sterile field extension, SMS reinforcement, 40 x 90 in. (101.6 x 228.6cm)			1	
8554N	Non-absorbent drape towel with adhesive strip, 15 x 26 in. (38 x 66cm)	6		6	
9460N	Peri-towel			1	
8470N	Plastic sheet, 50 x 59 in. (127 x 150cm)			1	
8152N	Heavy-duty back table cover, 80 x 110 in. (203 x 279cm), SMS reinforcement, 37 x 110 in. (94 x 279cm)				1
8143N	Standard back table cover, 50 x 90 in. (127 x 228.6cm), SMS reinforcement, 29 x 90 in. (73.6 x 228.6cm)	1		1	
	<b>Quantity per case</b>	<b>4</b>	<b>5</b>	<b>3</b>	<b>3</b>

Cardiovascular



**Surgical Drapes and Packs**

# Central line



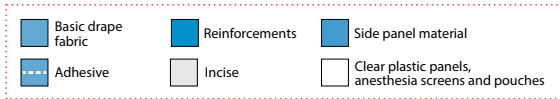

### Central Line Drape

Sterile No.	Nonsterile No.	Qty. Cs
C2324	C2324NS	30

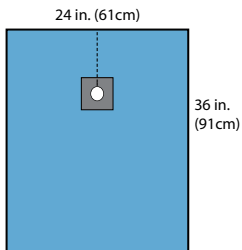

- Aperture: 4 in. dia. (10cm dia.)
- Perforated fenestration slit for easy removal

### Central Line Sheet

Sterile No.	Nonsterile No.	Qty. Cs
C2346	C2346NS	20/cs

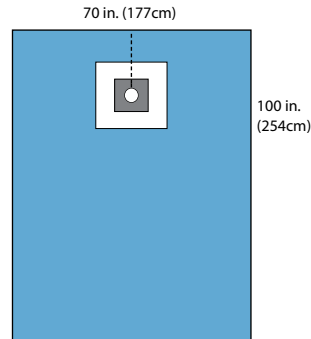

- Aperture: 4 in. dia. (10cm dia.)
- Perforated fenestration slit for easy removal

### Full Body Central Line Drape

Sterile No.	Nonsterile No.	Qty. Cs
29527	29527N	14

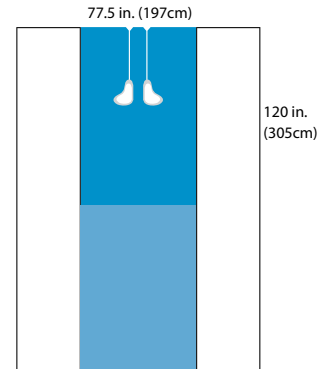

- Absorbent reinforcement, 36 x 57.5 in. (91 x 146cm)
- Fenestrations with incise aperture allow for intrajugular or subclavian access
- Clear side panels
- Easy removal feature on both fenestrations

### Jugular Sheet

Sterile No.	Nonsterile No.	Qty. Cs
C2315	C2315NS	20/cs

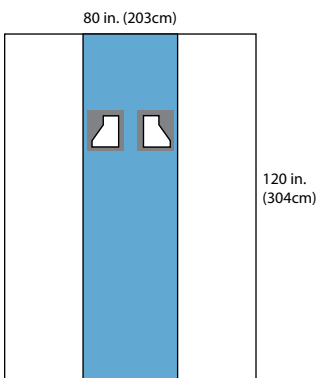

- Absorbent central panel, 29 x 120 in. (74 x 304cm)
- Clear side panels
- Apertures: 6 x 8 in. (15 x 20cm)



## PICC Line Insertion Drape

Sterile No.	Nonsterile No.	Qty. Cs
29668	29668N	10

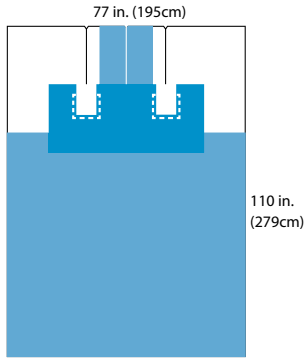

- Absorbent reinforcement, 52 x 27 in. (132 x 51cm)
- Fenestration with adhesive, dual for right or left side line placement, 6 x 4 in. (15 x 10cm)
- Notch at top center of drape allows user to create an opening to expose patient's face

## Line Insertion Draping System

Sterile No.	Nonsterile No.	Qty. Cs
29559	29559N	10

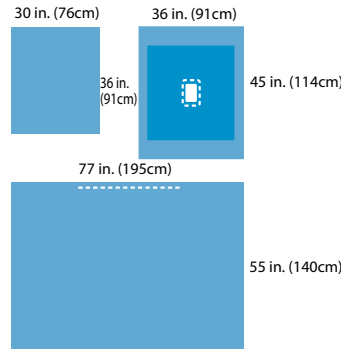

- Absorbent reinforcement, 30.5 x 30.5 in. (77.5 x 77.5cm)
- Fenestration with adhesive, 4 x 6 in. (10 x 15cm)
- Three-part draping system with prep pad, fenestrated drape and extension drape

## Line Insertion Drape

Sterile No.	Nonsterile No.	Qty. Cs
N/A	29557N	

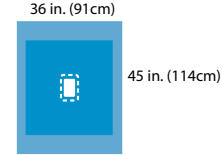

- Absorbent, reinforcement, 30.5 x 30.5 in. (77.5 x 77.5cm)
- Fenestration with adhesive, 4 x 6 in. (10 x 15cm)

## Dressing Change Pouch Organizer

Sterile No.	Nonsterile No.	Qty. Cs
N/A	2058NS	

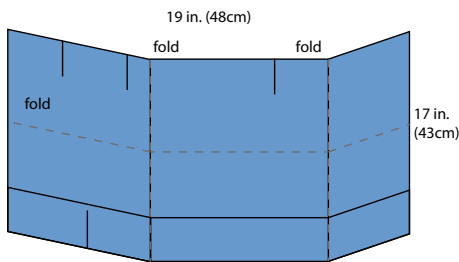

- Eight total pockets in organizer to allow for placement of dressing change supplies
- Four pockets on external fold
- Four pockets on internal fold
- Not AAMI rated

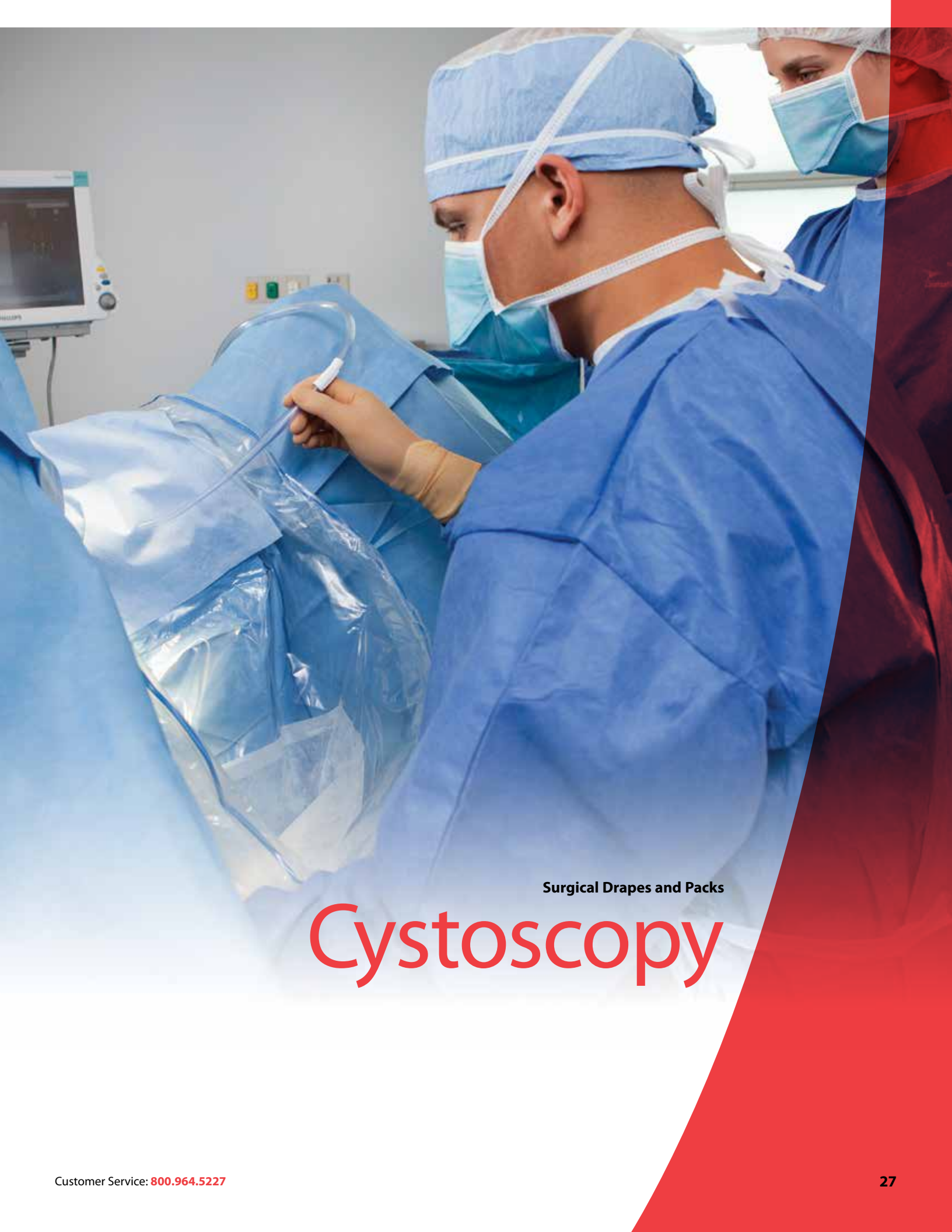

Surgical Drapes and Packs

# Cystoscopy

# Surgical Drapes and Packs

## Cystoscopy



Cystoscopy

### Cystoscopy "T" Drape

Sterile No.	Nonsterile No.	Qty. Cs
N/A	29437NA	

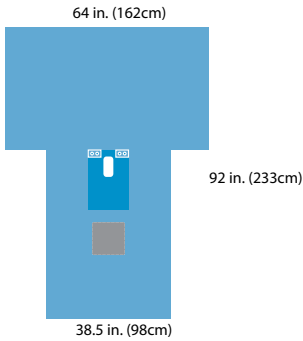

- Absorbent reinforcement, 12 x 21 in. (30.5 x 53cm)
- Fenestration, 3 x 6 in. (7.5 x 15cm)
- Mesh screen, 10 x 10 in. (25 x 25cm)
- Cord-holding tabs
- Included in packs 29470, 29471, 29480

### Urological Drape

Sterile No.	Nonsterile No.	Qty. Cs
N/A	29451N	

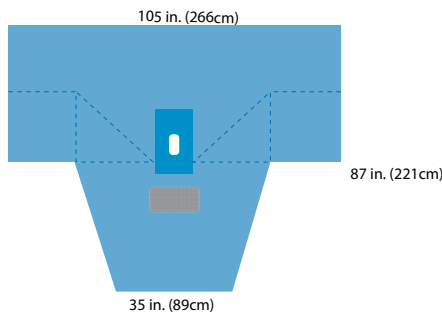

- Absorbent reinforcement, 12 x 19 in. (30.5 x 48cm)
- Fenestration, 3 x 6 in. (7.5 x 15cm)
- Mesh screen, 14 x 8 in. (35.5 x 20cm)
- Attached leggings
- Cord-holding tabs
- Included in pack 29360

### Lithotomy Drape with Fluid Control Pouch

Sterile No.	Nonsterile No.	Qty. Cs
29455	29455NA	8

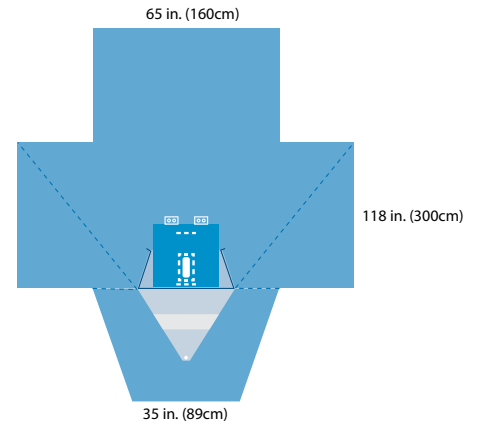

- Absorbent reinforcement, 20 x 19 in. (51 x 48cm)
- Fenestration with adhesive, 2.5 x 6.5 in. (6 x 16.5cm)
- Anesthesia screen
- Attached leggings
- Fluid control pouch with filtering screen, suction port, drawstring feature and side trough
- Cord-holding tabs

### Urological Drape

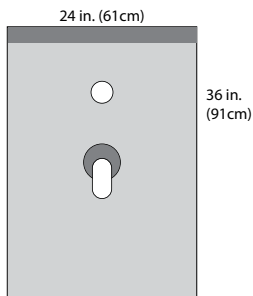

Sterile No.	Nonsterile No.	Qty. Cs
D1071	D1071NS	10

- Adhesive: 24 x 2.7 in. (61 x 7cm)
- Aperture: 1 in. dia. (2.5cm dia.)
- Finger Cot Adhesive: 4 in. dia. (10cm dia.)

### Cystoscopy Packs

Nonsterile No.	Description	29470 Cystoscopy Pack	29471 Cystoscopy Pack	29480 Cystoscopy Pack	29360 Cystoscopy Pack	9520E Cystoscopy Pack
29437NA	Cysto "T" drape, absorbent reinforcement	1	1	1		
29451N	Urological drape with absorbent reinforcement, attached leggings				1	
9461N	Drape Sheet, square-folded, 38.5 x 38.5 in. (98 x 98cm)					2
9515NA	AAMI 3 NonReinforced Surgical Gown, Large	1				
32474N	AAMI 4 Breathable Surgical Gown, X-large, X-long, Specialty		1			
8694-60	Suture bag	1	1	1	1	1
8520N	Absorbent towel	1	1	1	1	
8421N	Pair of leggings, X-large	1	1	1		1
8145N	Outer wrap/reinforced poly table cover 44 x 75 in. (112 x 190cm), reinforcement 24 x 75 in. (61 x 190cm)	1	1	1	1	1
<b>Quantity per case</b>		<b>10</b>	<b>8</b>	<b>14</b>	<b>10</b>	<b>10</b>



Surgical Drapes and Packs

# General surgery

# General surgery

## Setup Packs

Nonsterile No.	Description	114 Setup Pack	117 Setup Pack	119 Orthopedic Setup Pack	9102 Basic Pack
8554N	Drape towel, adhesive, nonabsorbent		4	4	
8337N	Mayo Stand Cover, reinforced poly, 23 in. (58cm) wide	1	1	1	1
8694-60	Suture bag	1	1	1	1
8476NA	U-Drape, poly, adhesive, 60 x 72 in. (152 x 183cm), 6 x 21 in. (15 x 53cm) split			1	
1582N	Stockinette, 12 x 48 in. (30 x 122cm), X-large			1	
3524N	Drape Tape			4	
8146N	Outer wrap, reinforced poly table cover, 44 x 90 in. (112 x 228cm)	1			
8143N	Outer wrap, reinforced poly table cover, 50 x 90 in. (127 x 228cm)		1		
8186N	Outer wrap, reinforced poly table cover, 60 x 90 in. (152 x 228cm), heavy-duty			1	1
<b>Quantity per case</b>		<b>12</b>	<b>13</b>	<b>4</b>	<b>12</b>

## Basic Packs

Nonsterile No.	Description	9100 Basic Pack	9101 Basic Pack	9103 Basic Pack	9111 Basic Pack	9112 Basic Pack	9113 Basic Pack	9114 Basic Pack	9131 Basic Pack
8520N	Absorbent towel				1		1	1	
8694-60	Suture bag	1	1	1	1	1	1	1	1
8337N	Mayo stand cover, reinforced poly, 23 in. (58cm) wide	1	1	1	1	1	1	1	1
8554N	Drape towel, adhesive, nonabsorbent	4		4	4	4	4	4	
9358N	Fan-folded Drape Sheet, 40 x 57 in. (101 x 145cm)	1		1					
9349N	Fan-folded Drape Sheet, 52 x 76 in. (132 x 193cm)	1		1	1	1	1	1	
90270NA	AAMI 3 NonReinforced Scrub Nurse Gown, Large, with towel and wrap		1	1			1		1
9515NA	AAMI 3 NonReinforced Surgical Gown, Large		1	1			1		1
90970N	AAMI 3 Fabric Reinforced Scrub Nurse Gown, Large, with towel and wrap				1				
9511N	AAMI 3 Fabric Reinforced Surgical Gown, Large				1				
9010N	AAMI 4 Poly Reinforced Surgical Gown, Large							1	
90680NA	AAMI 4 Poly Reinforced Scrub Nurse Gown, Large							1	
8143N	Outer wrap, reinforced poly table cover, 50 x 90 in. (127 x 228cm)							1	
8146N	Outer wrap, reinforced poly table cover, 44 x 90 in. (112 x 228cm)	1	1	1	1	1	1		
8186N	Outer wrap, reinforced poly table cover, 60 x 90 in. (152 x 228cm), heavy-duty								1
<b>Quantity per case</b>		<b>12</b>	<b>5</b>	<b>8</b>	<b>5</b>	<b>10</b>	<b>5</b>	<b>5</b>	<b>7</b>

# Surgical Drapes and Packs

## General surgery

General surgery



### Universal Pack

Sterile No.	Nonsterile No.
N/A	9467N
N/A	9465N
N/A	9468N

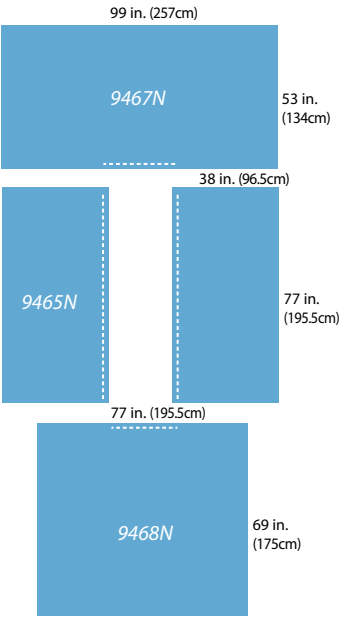

- Included in pack 9106

### Universal Pack

Sterile No.	Nonsterile No.
N/A	29467N
N/A	29465NA
N/A	29469N

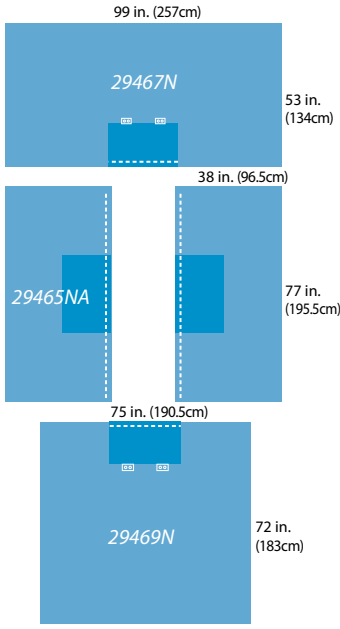

- Absorbent reinforcement with adhesive
- Cord-holding tabs
- Included in pack 29107

### Universal Pack

Sterile No.	Nonsterile No.
N/A	29667N
N/A	29665N
N/A	29669N

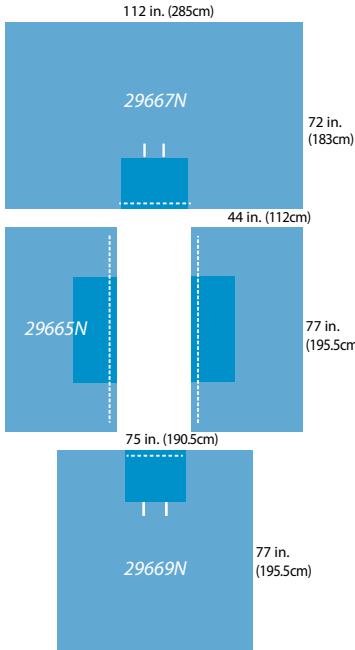

- Absorbent reinforcement with adhesive
- Cord-holding straps
- Included in pack 29118

### Universal Pack

Sterile No.	Nonsterile No.
N/A	TB29667N
N/A	TB29665N
N/A	TB29669N

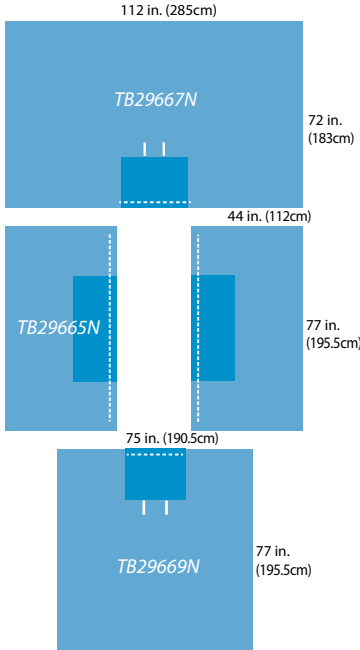

- Absorbent base drape fabric
- Absorbent reinforcement with adhesive
- Cord-holding straps
- Included in pack TB29118

### Universal Split Pack

Sterile No.	Nonsterile No.	Qty. Cs
29352	29351N	14
29440	29440NA	10

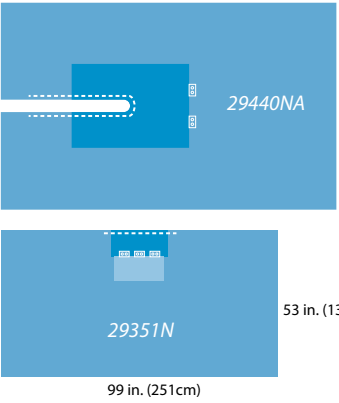

- Absorbent reinforcement
- Split, 6 x 46 in. (15 x 117cm) on 29440NA
- Instrument pad on 29351N
- Cord-holding tabs
- Included in pack 29131

### Universal Split Pack

Sterile No.	Nonsterile No.
N/A	29195N
N/A	29194N

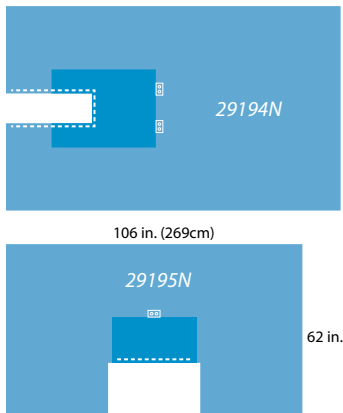

- Absorbent reinforcement
- Split, 12 x 30 in. (30.5 x 76cm) on 29194N
- Cord-holding tabs
- Included in pack 29133

 Basic drape fabric	 Reinforcements	 Side panel material
 Adhesive	 Incise	 Clear plastic panels, anesthesia screens and pouches

## Universal Packs

Nonsterile No.	Description	9106 Universal Pack	29107 Universal Pack	29118 Universal Pack	TB29118 Universal Pack, SFS	29131 Universal Split Pack	29133 Universal Split Pack II
9465N	Side Drape, 38 x 77 in. (96.5 x 195.5cm), adhesive	2					
9468N	Foot Drape, 77 x 69 in. (195.5 x 175cm), adhesive	1					
9467N	Head Drape, 99 x 53 in. (251 x 134cm), adhesive	1					
29465NA	Side Drape, 38 x 77 in. (96.5 x 195.5cm), adhesive, absorbent reinforcement		2				
29469N	Foot Drape, 75 x 72 in. (190.5 x 183cm), adhesive, absorbent reinforcement		1				
29467N	Head Drape, 99 x 53 in. (251 x 134cm), adhesive, absorbent reinforcement		1				
29440NA	Split Drape with absorbent reinforcement					1	
29351N	Top Drape, absorbent reinforcement, instrument pad					1	
29669N	Foot Drape, 75 x 77 in. (190.5 x 195.5cm), adhesive, absorbent reinforcement			1			
29667N	Head Drape, 112 x 72 in. (285 x 183cm), adhesive, absorbent reinforcement			1			
29665N	Side Drape, 44 x 77 in. (112 x 195.5cm), adhesive, absorbent reinforcement			2			
TB29667N	Head Drape, 112 x 72 in. (285 x 183cm), adhesive, absorbent reinforcement				1		
TB29665N	Side Drape, 44 x 77 in. (112 x 195.5cm), adhesive, absorbent reinforcement				2		
TB29669N	Foot Drape, 75 x 77 in. (190.5 x 195.5cm), adhesive, absorbent reinforcement				1		
29194N	Chest/Breast Drape						1
29195N	Bar Drape with armboard covers						1
90270NA	AAMI 3 NonReinforced Scrub Nurse Gown, Large, with towel and wrap		1				
9515NA	AAMI 3 NonReinforced Surgical Gown, Large		1				
8520N	Absorbent towel	1	1	1	1		
8554N	Drape towel, adhesive, nonabsorbent		4	4	4	4	4
8337N	Mayo stand cover, reinforced poly, 23 in. (58cm) wide	1	1	1	1	1	1
8694-60	Suture bag	1	1	1	1	1	1
8146N	Outer wrap, reinforced poly table cover, 44 x 90 in. (112 x 228.6cm)	1	1	1	1		
8143N	Outer wrap, reinforced poly table cover, 50 x 90 in. (127 x 228.6cm)					1	1
	<b>Quantity per case</b>	<b>5</b>	<b>6</b>	<b>6</b>	<b>6</b>	<b>4</b>	<b>10</b>



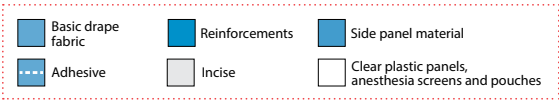

**Laparotomy Drape**

Sterile No.	Nonsterile No.	Qty. Cs
29410	29410N	12

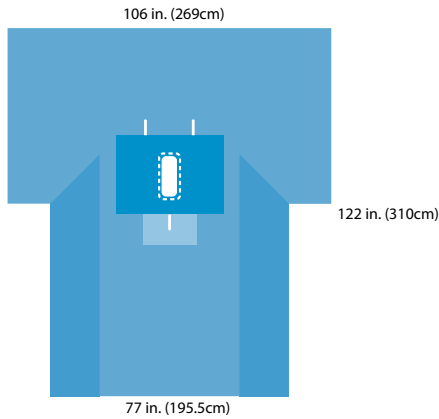

- Absorbent reinforcement, 30.5 x 30.5 in. (77.5 x 77.5 cm)
- Fenestration, 4 x 12 in. (10 x 30.5cm)
- Instrument pad
- Armboard covers
- Velcro® Cord-Holding Tabs
- Included in packs 29127, 29130, 29137, 29138, 29140

**Laparotomy Drape**

Sterile No.	Nonsterile No.	Qty. Cs
29411	N/A	9

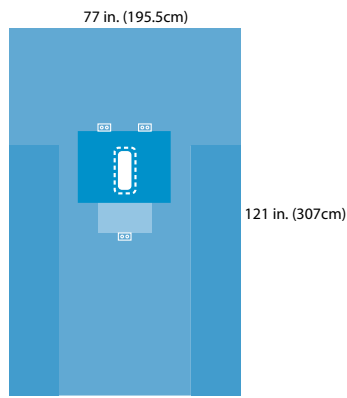

- Absorbent reinforcement, 30.5 x 30.5 in. (77.5 x 77.5 cm)
- Fenestration, 4 x 12 in. (10 x 30.5cm)
- Instrument pad
- Cord-holding tabs
- Included in pack 29120

**Transverse Laparotomy Drape**

Sterile No.	Nonsterile No.	Qty. Cs
29421	29421N	12

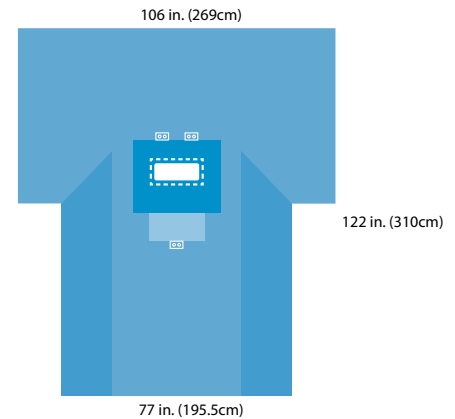

- Absorbent reinforcement, 30.5 x 30.5 in. (77.5 x 77.5 cm)
- Fenestration, 14 x 4 in. (35.5 x 10cm)
- Armboard covers
- Instrument pad
- Cord-holding tabs
- Included in pack 29121

**Pfannenstiel Laparotomy Drape**

Sterile No.	Nonsterile No.	Qty. Cs
29425	N/A	8

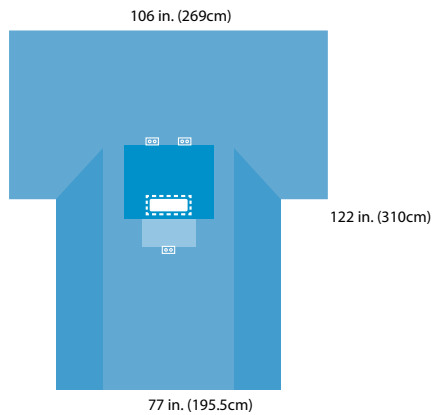

- Absorbent reinforcement, 30.5 x 30.5 in. (77.5 x 77.5 cm)
- Fenestration, 12 x 3 in. (30.5 x 7.5cm)
- Armboard covers
- Instrument pad
- Cord-holding tabs

**Laparotomy Incise Drape**

Sterile No.	Nonsterile No.	Qty. Cs
29510	29510N	14

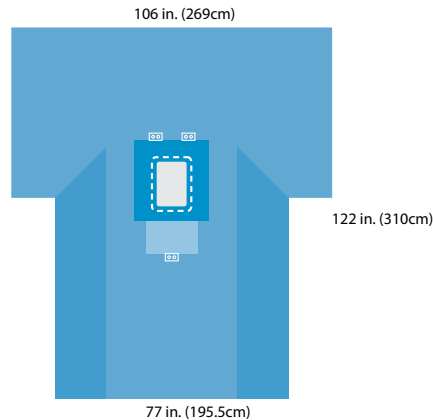

- Absorbent reinforcement, 30.5 x 30.5 in. (77.5 x 77.5 cm)
- Fenestration, full incise, 9 x 14.5 in. (23 x 37cm)
- Armboard covers
- Instrument pad
- Cord-holding tabs

**Laparotomy Drape with Pouches**

Sterile No.	Nonsterile No.	Qty. Cs
9430	9430N	12

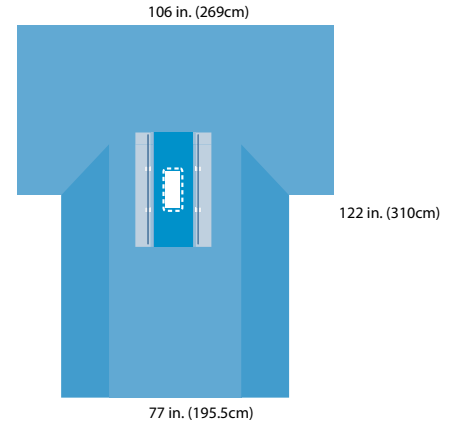

- Absorbent reinforcement, 14 x 38.5 in. (35.5 x 98cm)
- Fenestration, 4 x 12 in. (10 x 30.5cm)
- Armboard covers
- Dual clear closed end poly troughs with Velcro® Closures, 8 x 38.5 in (20 x 98cm)

# General surgery

 Basic drape fabric	 Reinforcements	 Side panel material
 Adhesive	 Incise	 Clear plastic panels, anesthesia screens and pouches

General surgery

## Minor Procedure Drape

Sterile No.	Nonsterile No.	Qty. Cs
29496	29496N	10

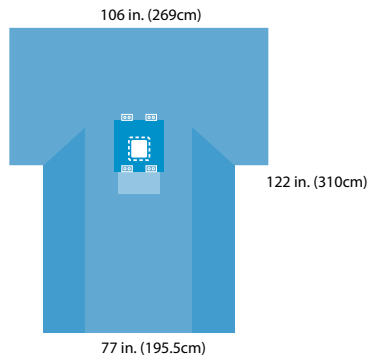

- Absorbent reinforcement, 19 x 19 in. (48 x 48cm)
- Fenestration, 6 x 6 in. (15 x 15cm)
- Armboard covers
- Instrument pad
- Cord-holding tabs

## Adolescent Laparotomy Drape

Sterile No.	Nonsterile No.	Qty. Cs
9418	9418N	10

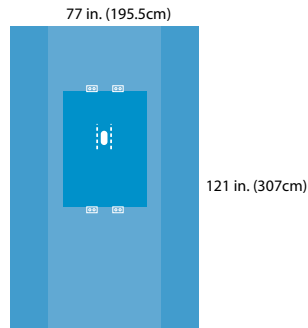

- Absorbent reinforcement, 35 x 44 in. (89 x 112cm)
- Fenestration, 2.5 x 5.5 in. (6 x 14cm)
- Cord-holding tabs

## Thyroid Drape

Sterile No.	Nonsterile No.	Qty. Cs
29522	29522N	12

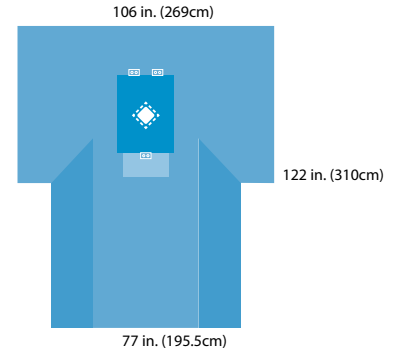

- Absorbent reinforcement, 23.5 x 30 in. (60 x 76cm)
- Fenestration, diamond, 5 x 5 in. (13 x 13cm)
- Armboard covers
- Instrument pad
- Cord-holding tabs

## Thyroid Drape

Sterile No.	Nonsterile No.	Qty. Cs
29422	29422N	10

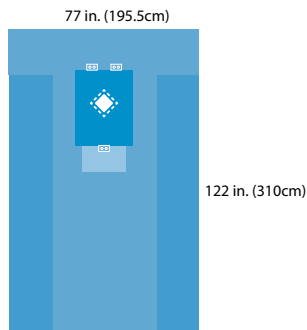

- Absorbent reinforcement, 22 x 30 in. (56 x 76cm)
- Fenestration, diamond, 5 x 5 in. (13 x 13cm)
- Instrument pad
- Cord-holding tabs

## Chest/Breast Drape

Sterile No.	Nonsterile No.	Qty. Cs
29420	29420N	12

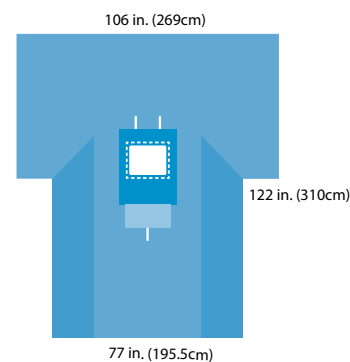

- Absorbent reinforcement, 30.5 x 30.5 in. (77.5 x 77.5 cm)
- Fenestration, 14 x 11 in. (35.5 x 28cm)
- Armboard covers
- Instrument pad
- Velcro® Cord-Holding Tabs

## Laparoscopic Cholecystectomy Drape with Pouches

Sterile No.	Nonsterile No.	Qty. Cs
9428	9428NA	8

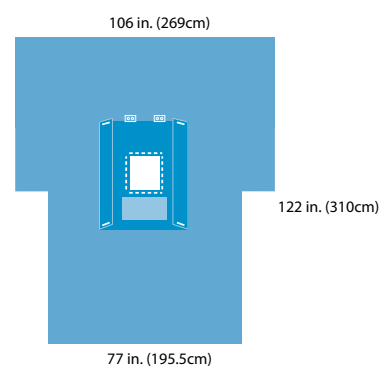

- Absorbent reinforcement, 36 x 42 in. (91 x 107cm)
- Fenestration, 14 x 11 in. (35.5 x 28cm)
- Armboard covers
- Instrument pad
- Velcro® Cord-Holding Tabs
- Instrument pad

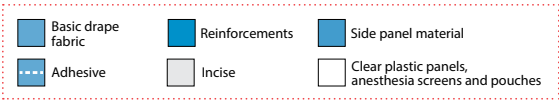

**Laparoscopic Abdominal Drape**

Sterile No.	Nonsterile No.	Qty. Cs
9438	9438N	12

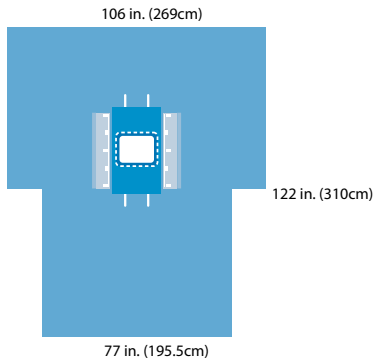

- Absorbent reinforcement, 20 x 35.5 in. (51 x 90cm)
- Fenestration, 14 x 11 in. (35.5 x 28cm)
- Armboard covers
- Two separate clear pouches on each side, 10.5 x 30 in. (27 x 76cm), feature a shared malleable wire
- Velcro® Cord-Holding Tabs

**General Endoscopy Drape**

Sterile No.	Nonsterile No.	Qty. Cs
9458	9458N	12

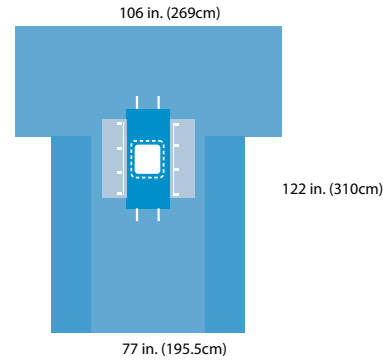

- Absorbent reinforcement, 16 x 38.5 in. (40.5 x 98cm)
- Fenestration, 10 x 11 in. (25.5 x 28cm)
- Armboard covers
- Dual clear open ended poly troughs with Velcro® Closure, 11.125 x 30 in. (28 x 76cm)
- Velcro® Cord-Holding Tabs
- Included in pack 9120

**Bariatric Drape**

Sterile No.	Nonsterile No.	Qty. Cs
94590	94590N	8

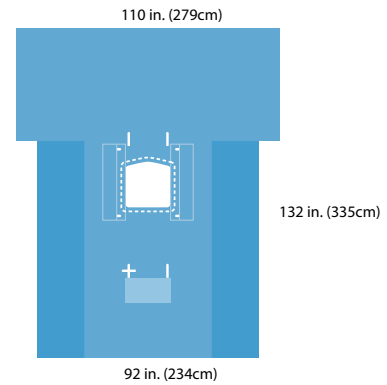

- Fenestration, chevron, 18 x 18 in. (45.5 x 45.5cm)
- Armboard covers
- Fabric instrument troughs, 28.5 x 24 in. (72 x 61cm)
- Instrument pad
- Velcro® Cord-Holding Tabs

**Major Abdominal Drape with Pouches**

Sterile No.	Nonsterile No.	Qty. Cs
9457	9457N	12

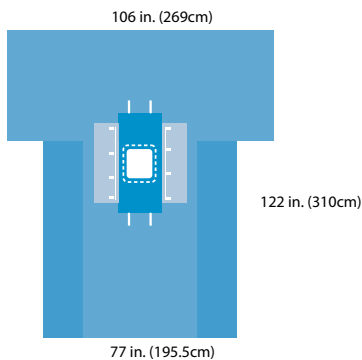

- Absorbent reinforcement, 16 x 38.5 in. (40.5 x 98cm)
- Fenestration, 10 x 11 in. (25.5 x 28cm)
- Armboard covers
- Dual clear pouches with Velcro® Closure, 11.125 x 30 in. (28 x 76cm)
- Velcro® Cord-Holding Tabs

# General surgery

## Laparotomy Packs

Nonsterile No.	Description	29127	29130	29137	29138	29140	29120	29121
		Laparotomy Pack	Laparotomy Pack	Laparotomy Pack	Laparotomy Pack	Laparotomy Pack	Laparotomy Pack	Transverse Laparotomy Pack
9358N	Half Drape, 40 x 57 in. (101 x 145cm)	2					2	
29410N	Laparotomy Drape, absorbent reinforcement	1	1	1	1	1		
29411N	Laparotomy Drape, absorbent reinforcement						1	
29421N	Laparotomy Drape, absorbent reinforcement							1
90680NA	AAMI 4 Poly Reinforced Scrub Nurse Gown, Large		1					
9010N	AAMI 4 Poly Reinforced Surgical Gown, Large		1					
90270NA	AAMI 3 NonReinforced Scrub Nurse Gown, Large, with towel and wrap					1		1
9515NA	AAMI 3 NonReinforced Surgical Gown, Large					1		1
9511N	AAMI 3 Fabric Reinforced Surgical Gown, Large	2		2				
8554N	Drape towel, adhesive, nonabsorbent	4	4	4	4	4	4	4
8520N	Absorbent towel	3	1	2	1		1	1
8337N	Mayo stand cover, reinforced poly, 23 in. (58cm) wide	1	1	1	1	1	1	1
8694-60	Suture bag	1	1	1	1	1	1	1
8146N	Outer wrap, reinforced poly table cover, 44 x 90 in. (111.7 x 228.6cm)	1		1	1	1	1	1
8143N	Outer wrap, reinforced poly table cover, 50 x 90 in. (127 x 228.6cm)		1					
<b>Quantity per case</b>		<b>6</b>	<b>4</b>	<b>6</b>	<b>10</b>	<b>4</b>	<b>5</b>	<b>6</b>

## General Endoscopy Pack

Nonsterile No.	Description	9120
		General Endoscopy Pack
9458N	General Endoscopy Drape	1
90270NA	AAMI 3 NonReinforced Scrub Nurse Gown, Large, with towel and wrap	1
9515NA	AAMI 3 NonReinforced Surgical Gown, Large	2
8554N	Drape towel, adhesive, nonabsorbent	4
7148N	X-ray detectable sponge, 4 x 4 in. (10 x 10cm)	10
8337N	Mayo stand cover, reinforced poly, 23 in. (58cm) wide	1
8694-60	Suture bag	1
8146N	Outer wrap, reinforced poly table cover, 44 x 90 in. (111.7 x 228.6cm)	1
<b>Quantity per case</b>		<b>6</b>



Surgical Drapes and Packs

# Neurosurgery



## Craniotomy Drape

Sterile No.	Nonsterile No.	Qty. Cs
9450	9450N	7

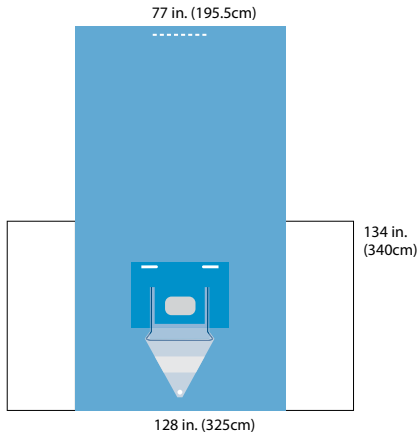

- Absorbent reinforcement, 35 x 22 in. (89 x 56cm)
- Fenestration, oval with full incise, 11 x 7 in. (28 x 18cm)
- Clear anesthesia panels
- Fluid control drawstring pouch with screen and port
- Velcro® Cord-Holding Tabs

## Neurological Drape

Sterile No.	Nonsterile No.	Qty. Cs
9448	9448N	8

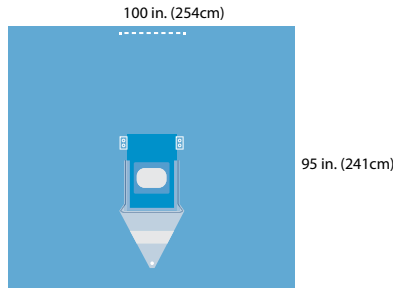

- Absorbent reinforcement, 18.5 x 28.5 in. (47 x 72cm)
- Fenestration, oval with full incise, 11 x 7 in. (28 x 18cm)
- Fluid control drawstring pouch with screen and port, 20.5 x 40 in. (52 x 101.5cm)
- Cord-holding tabs

## Neurological Drape

Sterile No.	Nonsterile No.	Qty. Cs
9449	9449N	8

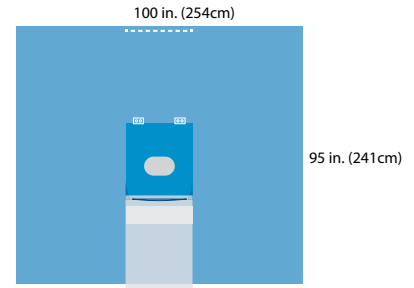

- Absorbent reinforcement, 35 x 28 in. (89 x 71cm)
- Fenestration, oval with full incise, 11 x 7 in. (28 x 18cm)
- Extra-large fluid control drawstring pouch with screen and port
- Cord-holding tabs

## Universal Spine Drape

Sterile No.	Nonsterile No.	Qty. Cs
29418	29418N	7

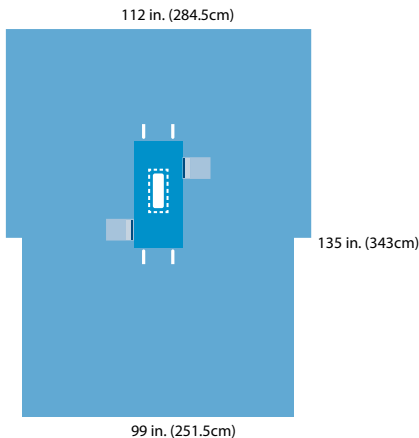

- Absorbent reinforcement, 20 x 37 in. (51 x 94cm)
- Fenestration, 4 x 12 in. (10 x 30.5cm)
- Armboard covers
- Instrument pouches, 7.5 x 12 in. (19 x 30.5cm)
- Velcro® Cord-Holding Tabs

## Craniotomy Split Drape

Sterile No.	Nonsterile No.	Qty. Cs
9439	9439N	8

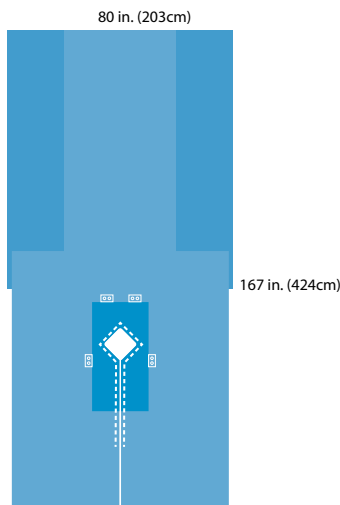

- Absorbent reinforcement, 20 x 38 in. (51 x 96.5cm)
- Fenestration, diamond, 8 x 8 in. (20 x 20cm)
- Split, 54 in. (137cm)
- Attached overhead table cover, 80 x 90 in. (203 x 228.5cm)
- Cord-holding tabs

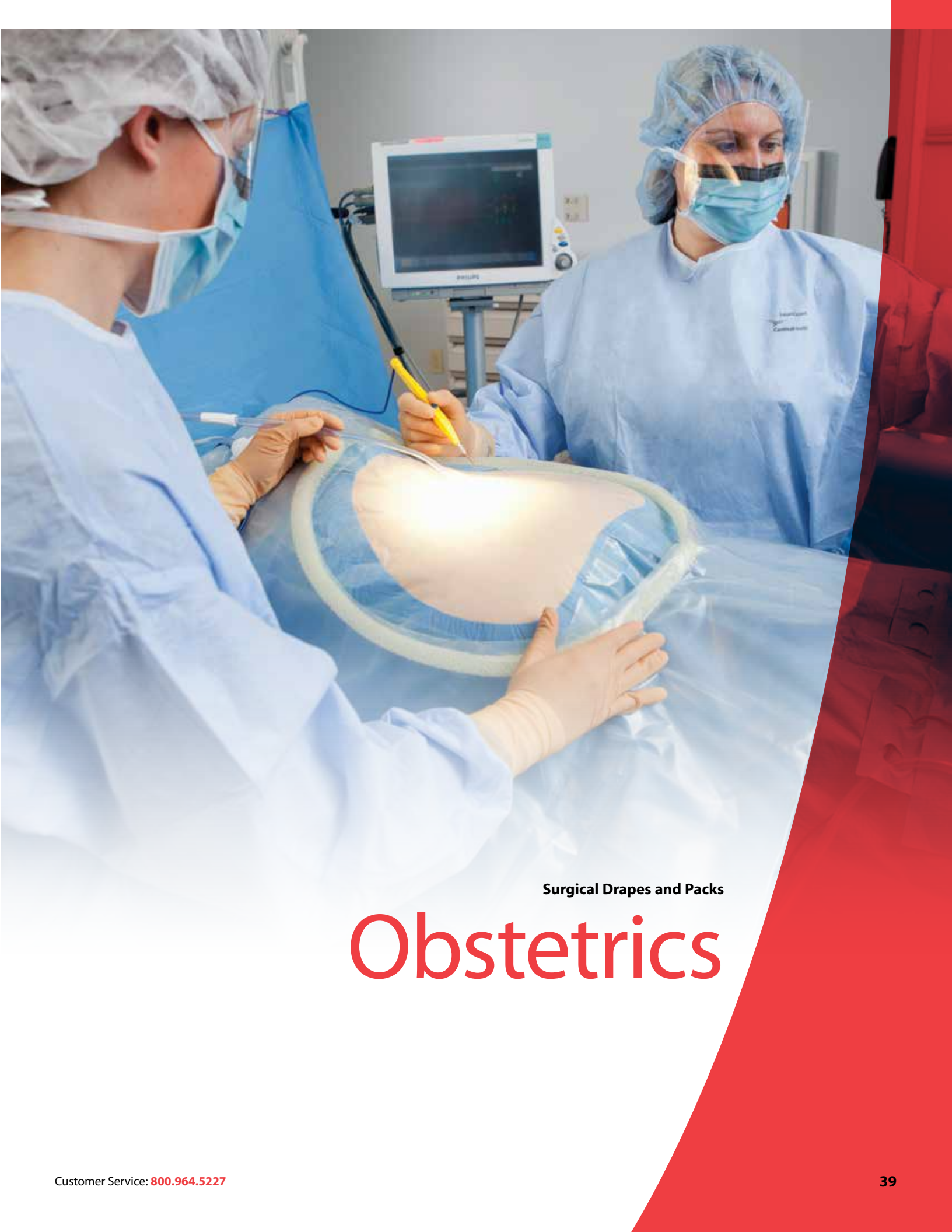

Surgical Drapes and Packs

# Obstetrics

# Surgical Drapes and Packs

## Obstetrics

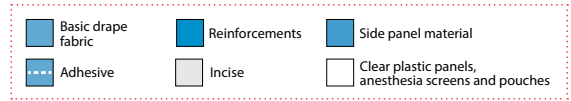

Obstetrics

### Cesarean Birth Drape

Sterile No.	Nonsterile No.	Qty. Cs
29449	29449N	7

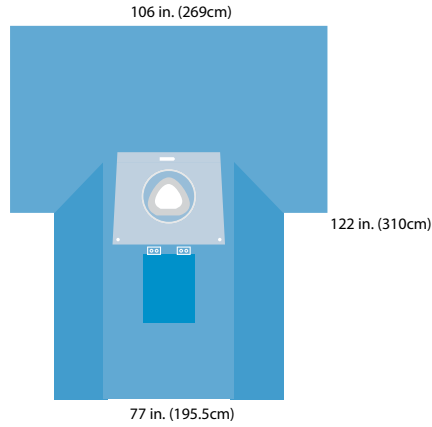

- Fenestration, pear-shaped with 2 in. (5cm) incise, 12 x 14 in. (30.5 x 35.5cm)
- Reinforcement below pouch, 17 x 22 in. (43 x 56cm)
- Armboard covers
- 360-degree fluid control pouch with contoured foam ring, Velcro® Cord-Holding tab and ports
- Cord-Holding Tabs

### Cesarean Birth Drape

Sterile No.	Nonsterile No.	Qty. Cs
29443	29443N	7

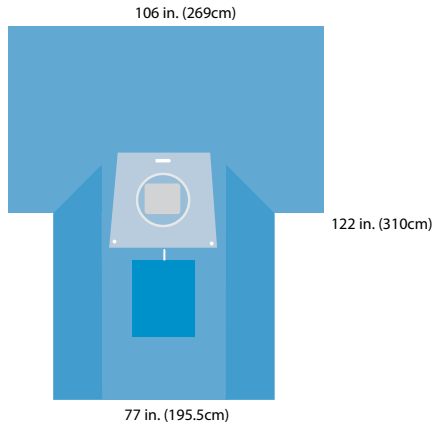

- Fenestration, full incise, 9 x 14 in. (23 x 35.5cm)
- Reinforcement below pouch, 17 x 22 in. (43 x 56cm)
- Armboard covers
- 360-degree fluid control pouch with contoured foam ring, Velcro® Cord-Holding tab and ports
- Velcro® Cord-Holding Tabs

### Cesarean Birth Drape

Sterile No.	Nonsterile No.	Qty. Cs
29448	29448N	7

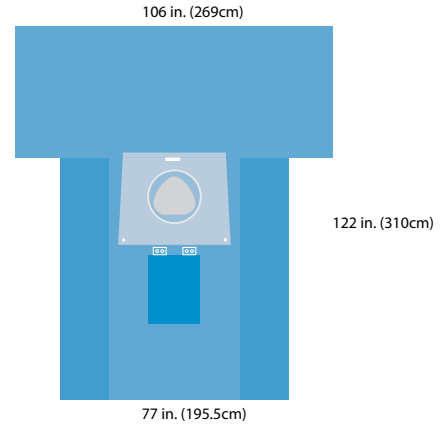

- Fenestration, pear-shaped with full incise, 12 x 14 in. (30.5 x 35.5cm)
- Reinforcement below pouch, 17 x 22 in. (43 x 56cm)
- Armboard covers
- 360-degree fluid control pouch with contoured foam ring, Velcro® Cord-Holding tab and ports
- Cord-holding tabs

### Cesarean Birth Drape

Sterile No.	Nonsterile No.	Qty. Cs
29452	29452N	8

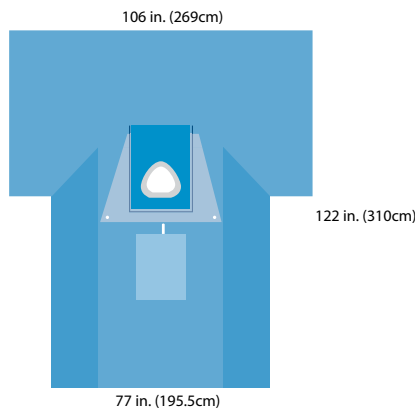

- Fenestration, pear-shaped with 2 in. (5cm) incise, 12 x 14 in. (30.5 x 35.5cm)
- Reinforcement around fenestration (20.375 x 27 in. (51.8 x 68.6cm)) and below pouch (17 x 22 in. (43 x 56cm))
- Armboard covers
- 270-degree fluid control pouch with malleable wire
- Velcro® Cord-Holding Tabs

### Cesarean Birth Drape

Sterile No.	Nonsterile No.	Qty. Cs
29447	29447N	8

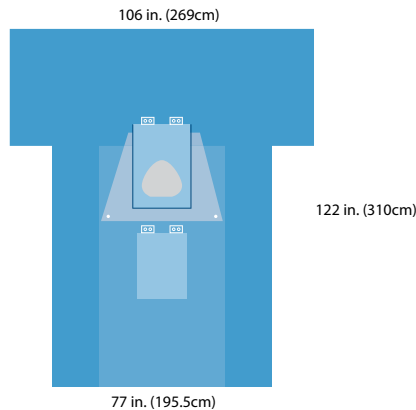

- Fenestration, pear-shaped with full incise, 12 x 14 in. (30.5 x 35.5cm)
- Reinforcement around fenestration (20.375 x 27 in. (51.8 x 68.6cm)) and below pouch (17 x 22 in. (43 x 56cm))
- Armboard covers
- 270-degree fluid control pouch with malleable wire and ports
- Cord-holding tabs

### Cesarean Birth Drape with Dual Layer Anesthesia Screen

Sterile No.	Nonsterile No.	Qty. Cs
29442	29442N	7

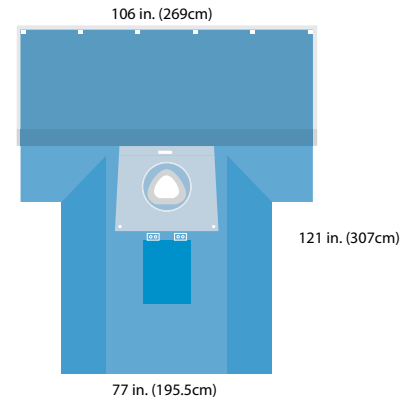

- Fenestration, pear-shaped with 2 in. (5cm) incise, 12 x 14 in. (30.5 x 35.5cm)
- Reinforcement below pouch, 17 x 22 in. (43 x 56cm)
- Armboard covers
- Dual layer anesthesia screen with clear film layer for patient visibility
- 360-degree fluid control pouch with contoured foam ring, Velcro® Cord-Holding tab and ports
- Cord-Holding Tabs



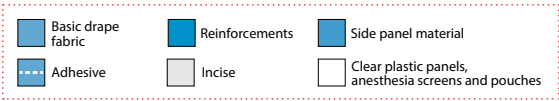

### Cesarean Birth Drape

Sterile No.	Nonsterile No.	Qty. Cs
N/A	29453N	

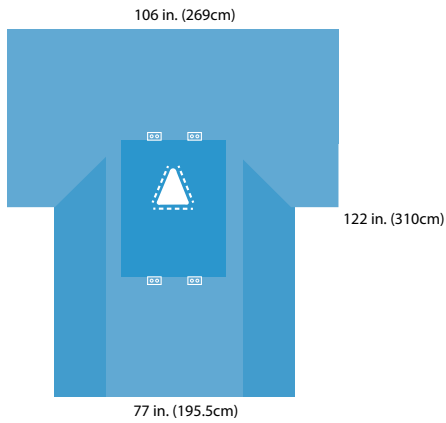

- Fenestration, triangular with adhesive, 12 x 10.5 in. (30.5 x 27cm)
- Reinforcement, 30.5 x 37 in. (77.5 x 94cm)
- Armboard covers
- Cord-holding tabs

### Cesarean Pouch

Sterile No.	Nonsterile No.	Qty. Cs
D2057	D2057NS	10

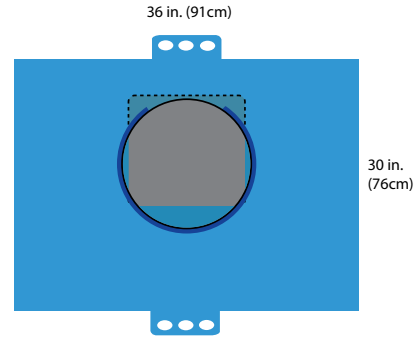

- Adhesive Area: 15 x 14.5 in. (38 x 36cm)
- 360-degree fluid control pouch with contoured foam ring

### Abdominal Cover

Sterile No.	Nonsterile No.	Qty. Cs
N/A	29357N	

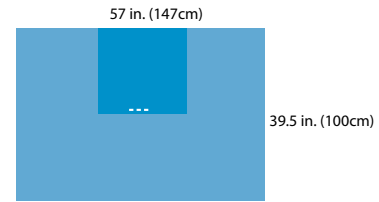

- Absorbent reinforcement, 19 x 19 in. (48 x 48cm)
- Included in pack 29920

### Obstetrical Pack

Nonsterile No.	Description	29920 Obstetrical Pack
29357N	Abdominal cover	1
8421N	Pair of leggings, X-large	1
8483N	Under-buttocks drape, reinforced poly	1
8365N	Setup cover, 44 x 71 in. (111.7 x 180cm)	1
8520N	Absorbent towel	2
8145N	Outer wrap/reinforced poly table cover 44 x 75 in. (111.7 x 190.5cm), reinforcement 24 x 75 in. (61 x 190.5cm)	1
<b>Quantity per case</b>		<b>6</b>



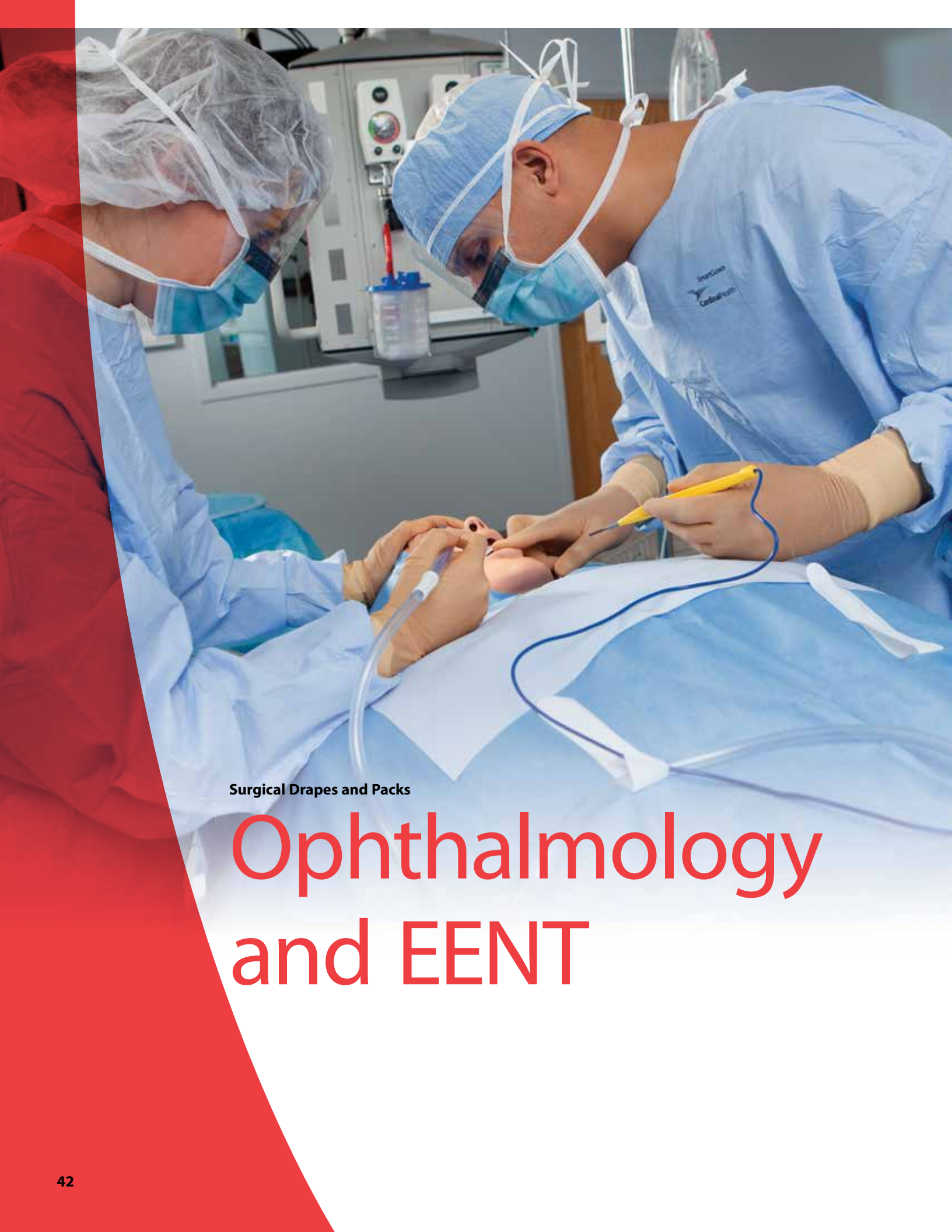

Surgical Drapes and Packs

# Ophthalmology and EENT

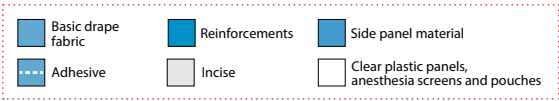

### Small Drape with Adhesive Aperture

Sterile No.	Nonsterile No.	Qty. Cs
8441	8441N	40

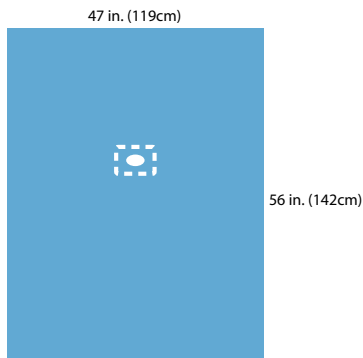

- Oval fenestration 2 x 3 in. (5 x 7.5cm)

### Ophthalmic Incise Drape

Sterile No.	Nonsterile No.	Qty. Cs
C2312*	C2312NS	30

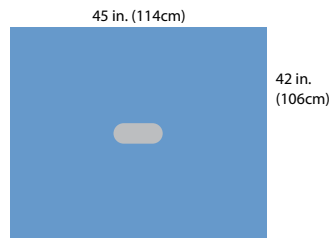

- Incise Area: 7.5 x 3.25 in. (18 x 8cm)

### Blepharoplasty Drape

Sterile No.	Nonsterile No.	Qty. Cs
D2361	N/A	10

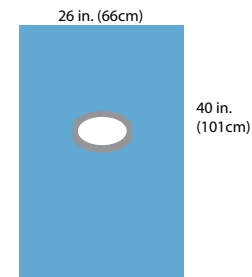

- Aperture: 8 x 5 in. (12.7 x 20.3 cm)

### Aperture Drape

Sterile No.	Nonsterile No.	Qty. Cs
D2147	N/A	30

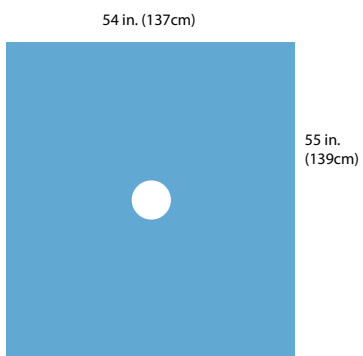

- Aperture: 4 in. dia. (10cm dia.)
- No adhesive

### Ophthalmic Incise Drape

Sterile No.	Nonsterile No.	Qty. Cs
D2019	D2019NS	30

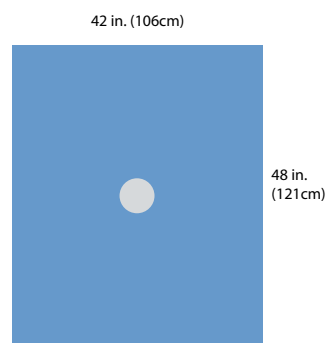

- Incise Area: 3 in. dia. (7cm dia.)

### Ophthalmic Drape

Sterile No.	Nonsterile No.	Qty. Cs
7444	7444N	10

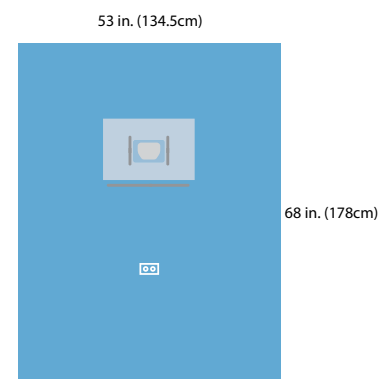

- Dual saddlebag fluid control pouches with malleable strips
- Malleable breather-bar
- Cord-holding tab
- Full incise, 4 x 5 in. (10 x 13cm)

# Ophthalmology and EENT

Basic drape fabric	Reinforcements	Side panel material
Adhesive	Incise	Clear plastic panels, anesthesia screens and pouches

## Ophthalmic Drape

Sterile No.	Nonsterile No.	Qty. Cs
7445	7445N	10

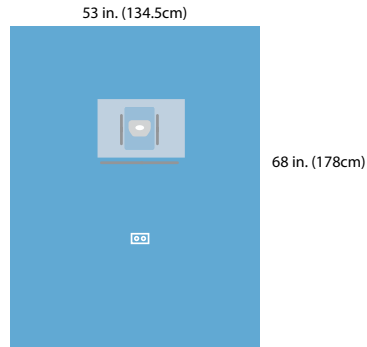

- Dual saddlebag fluid control pouches with malleable strips
- Malleable breather-bar
- Cord-holding tab
- Oval incise aperture, 1.5 x 2.5 in. (4 x 6cm)

## Ophthalmic Incise Drape

Sterile No.	Nonsterile No.	Qty. Cs
D1062	D1062NS	10

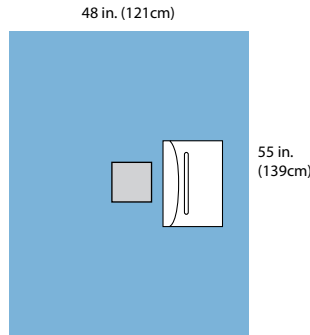

- Incise Area: 4 x 4 in. (10 x 10cm)
- Pouch: 11 x 12 in. (28 x 30cm)

## Aperture Drape

Sterile No.	Nonsterile No.	Qty. Cs
C2350A	N/A	10

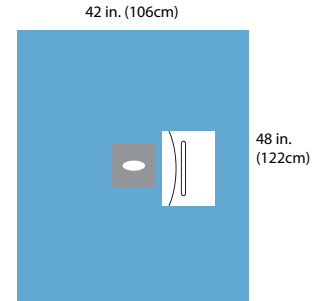

- Aperture: 2 x 1.25 in. (5 x 3cm)
- Pouch: 11 x 12 in. (28 x 30cm)

## Ophthalmic Drape with Pouch

Sterile No.	Nonsterile No.	Qty. Cs
9562	9562N	10

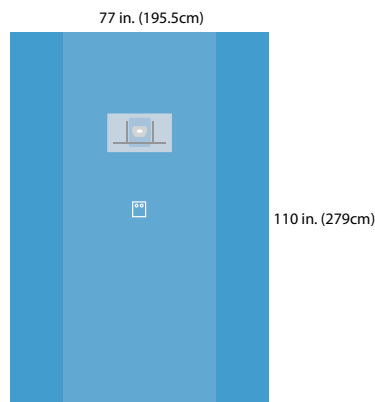

- Attached fluid control saddlebag pouch
- Malleable breathing bar
- Cord-holding tab
- Oval aperture with incise, 1.5 x 2.5 in. (4 x 6cm)
- Separate incise sheet, 5 x 4 in. (13 x 10cm)

## Ophthalmic Incise Sheet

Sterile No.	Nonsterile No.	Qty. Cs
D1165	D1165NS	20

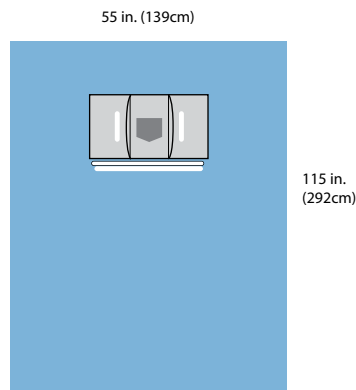

- Attached fluid control saddlebag pouch
- Malleable breathing bar
- Full incise, 5 x 4.5 in. (12 x 11cm)

## Eye Drape with Pouch

Sterile No.	Nonsterile No.	Qty. Cs
9565	9565N	10

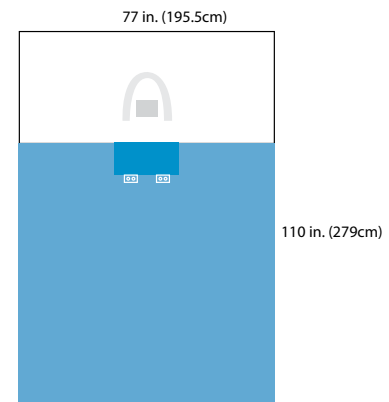

- Attached fluid control pouch with port specifically designed for use with a wrist rest
- Clear view top panel, 77 x 35 in. (195.5 x 89cm)
- Cord-holding tabs
- Full incise, 5 x 4 in. (13 x 10cm)
- Instrument pad



## EENT Split Drape

Sterile No.	Nonsterile No.	Qty. Cs
N/A	9442N	

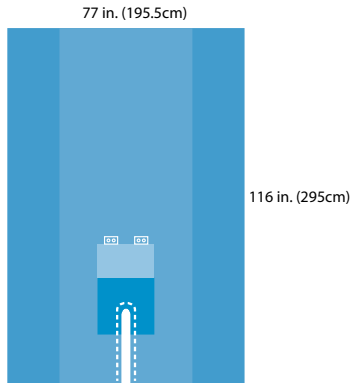

- Absorbent reinforcement, 17 x 20 in. (43 x 51 cm)
- Split with adhesive, 2.5 x 2.5 in. (63.5 x 6 cm)
- Instrument pad, 18 x 10 in. (46 x 25 cm)
- Cord-holding tabs
- Included in pack 9194

## Large EENT Split Drape

Sterile No.	Nonsterile No.	Qty. Cs
9447	9447N	8

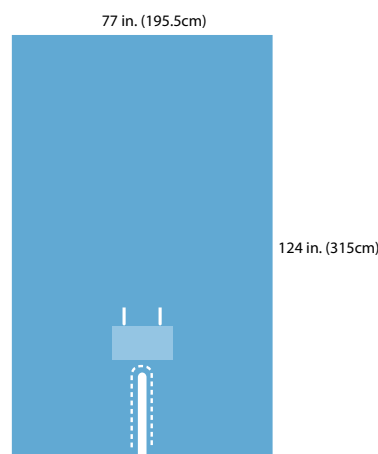

- Split with adhesive, 2.5 x 2.5 in. (6 x 63.5 cm)
- Instrument pad
- Velcro® Cord-Holding Tabs
- Included in pack 9196

## Large EENT Split Drape

Sterile No.	Nonsterile No.	Qty. Cs
TB9441	9441N	8

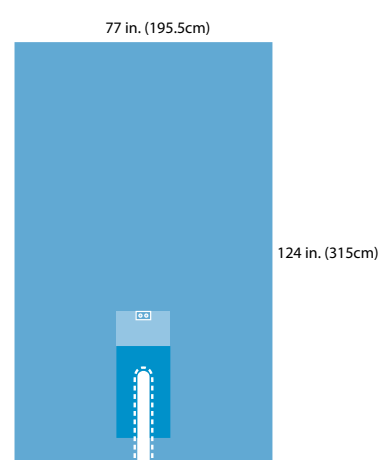

- Absorbent reinforcement, 15.25 x 28 in. (39 x 71 cm)
- Split with adhesive, 3.5 x 28 in. (9 x 71 cm)
- Instrument pad, 15.25 x 9.5 in. (38 x 24 cm)
- Cord-holding tabs

## Head/Bar Drape

Sterile No.	Nonsterile No.	Qty. Cs
9556	9556N	20

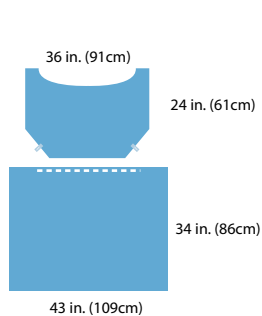

- Cord-holding tabs
- Turban
- Included in pack 9194, 9196

## Bar Drape

Sterile No.	Nonsterile No.	Qty. Cs
N/A	9557N	

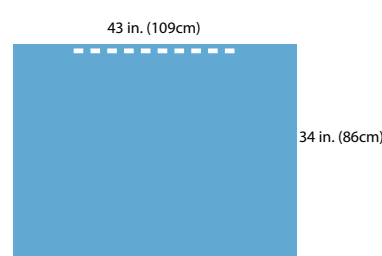

- Adhesive

# Ophthalmology and EENT

 Basic drape fabric	 Reinforcements	 Side panel material
 Adhesive	 Incise	 Clear plastic panels, anesthesia screens and pouches

## Ophthalmic Incise Drape

Sterile No.	Nonsterile No.	Qty. Cs
D1021	D1021NS	10

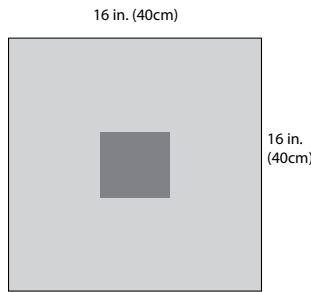

- Incise Area: 5 x 4.25 in. (12 x 11cm)

## Aperture Drape

Sterile No.	Nonsterile No.	Qty. Cs
D1020	D1020NS	10

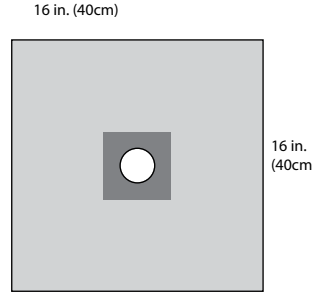

- Aperture: 2.5 in. dia. (6cm dia.)

## Refractive Drape

Sterile No.	Nonsterile No.	Qty. Cs
D1122	N/A	10

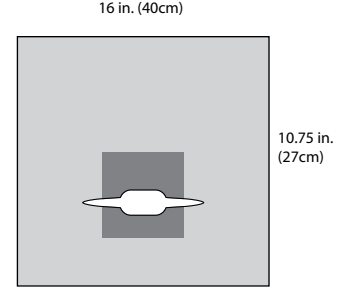

- Aperture: 1.5 x 1 in. (3.8 x 2.5cm)

## Ophthalmic Incise Pouch

Sterile No.	Nonsterile No.	Qty. Cs
D1025	D1025NS	10

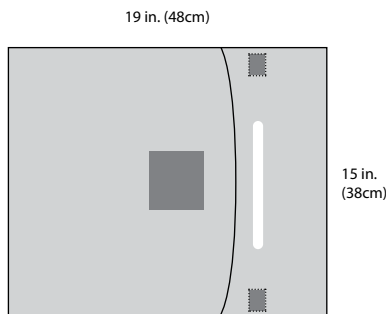

- Incise Area: 5 x 4.25 in. (12 x 11cm)
- Adhesive Tabs: (2) 1 x 2 in. (2.5 x 5cm)

## Ophthalmic Aperture Drape

Sterile No.	Nonsterile No.	Qty. Cs
D1024	D1024NS	10

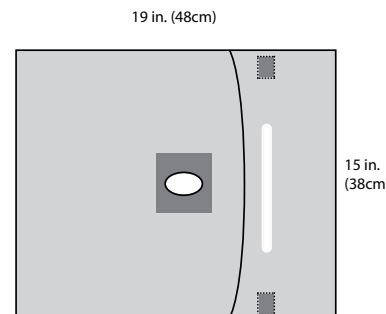

- Aperture: 2 x 1.5 in. (5cm x 4cm)
- Adhesive Tabs: (2) 1 x 2 in. (2.5 x 5cm)

## Aperture Drape

Sterile No.	Nonsterile No.	Qty. Cs
MCDC2321	N/A	30

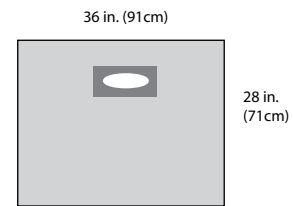

- Aperture: 6.3 x 2.3 in. (16 x 5.8cm)

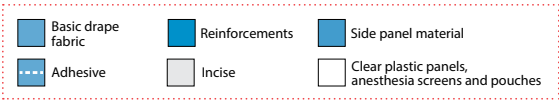

### Strabismus Drape

Sterile No.	Nonsterile No.	Qty. Cs
D2043	D2043NS	10

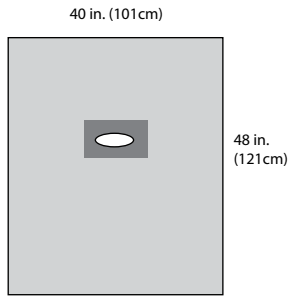

- Aperture: 5.2 x 1.5 in. (13 x 4cm)

### Ophthalmic Incise Drape

Sterile No.	Nonsterile No.	Qty. Cs
D1060	D1060NS	10

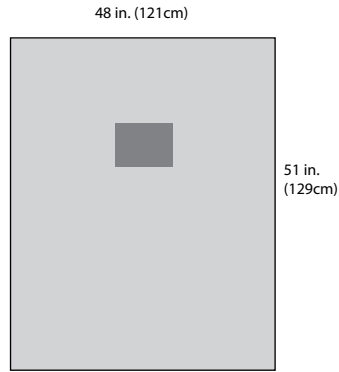

- Incise Area: 5 x 4.25 in. (12 x 11cm)

### Aperture Drape

Sterile No.	Nonsterile No.	Qty. Cs
D1030	D1030NS	10

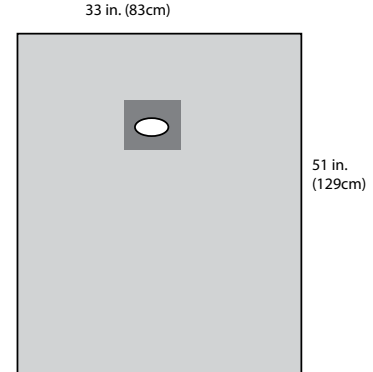

- Aperture: 3 x 2 in. (7 x 5cm)

### Ophthalmic Incise Drape

Sterile No.	Nonsterile No.	Qty. Cs
D1061	D1061NS	10

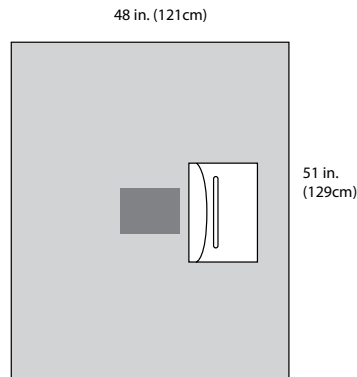

- Incise Area: 5 x 4.25 in. (12 x 11cm)
- Pouch: 11 x 12 in. (28 x 30cm)

### Ophthalmic Aperture Drape

Sterile No.	Nonsterile No.	Qty. Cs
D1031	D1031NS	10

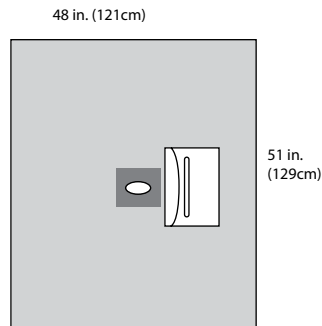

- Aperture: 3 x 2 in. (7 x 5cm)
- Pouch: 11 x 12 in. (28 x 30cm)

### Ophthalmic Incise Drape

Sterile No.	Nonsterile No.	Qty. Cs
D2258	N/A	10

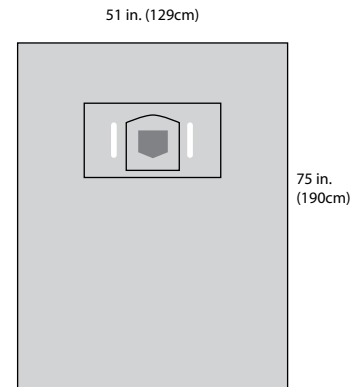

- Incise Area: 4.5 x 5 in. (11 x 12cm)
- Pouch: 21 x 11.5 in. (53 x 29cm)

# Ophthalmology and EENT

## Head and Neck Packs

Nonsterile No.	Description	9194 Head and Neck Pack	9196 Head and Neck Pack
9556N	Head/Bar Drape, adhesive	1	1
9442N	Split Drape, reinforced, adhesive	1	
9447N	Large EENT split drape		1
90270NA	AAMI 3 NonReinforced Scrub Nurse Gown, Large, with towel and wrap	1	1
9515NA	AAMI 3 NonReinforced Surgical Gown, Large	1	1
8554N	Drape towel, adhesive, nonabsorbent	2	2
8520N	Absorbent towel	1	1
8337N	Mayo stand cover, reinforced poly, 23 in. wide (58cm)	1	1
8694-60	Suture bag	1	1
8146N	Outer wrap, reinforced poly table cover, 44 x 90 in. (111.7 x 228.6cm)	1	1
	<b>Quantity per case</b>	<b>6</b>	<b>6</b>





Surgical Drapes and Packs

# Orthopedics

# Orthopedics - Heavy Duty



Orthopedics

## HD Extremity Drape

Sterile No.	Nonsterile No.	Qty. Cs
59405	59405N	6

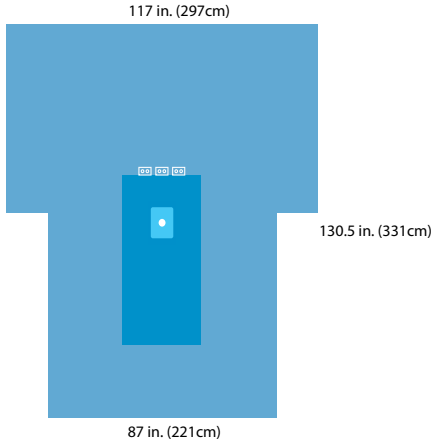

- Heavyweight, premium fabric
- Absorbent reinforcement, 30.5 x 55.5 in. (77.5 x 141cm)
- Fenestration, circular elastic, 2.5 in. (6cm)
- Anesthesia screen
- Armboard covers
- Cord-holding tabs
- Included in pack 59180

## HD Arthroscopy Drape

Sterile No.	Nonsterile No.	Qty. Cs
59413	59413N	6

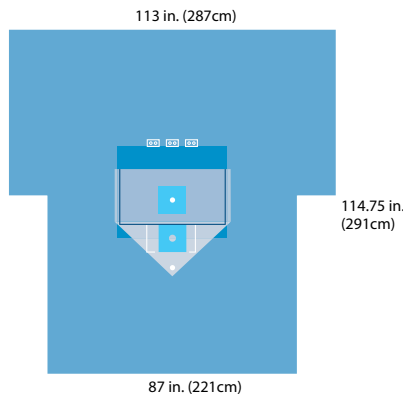

- Heavyweight, premium fabric
- Absorbent reinforcement
- Dual fenestration, circular elastic, 2 in. (6cm)
- Anesthesia screen
- Armboard covers
- Cord-holding tabs
- Fluid control pouch with malleable wire drawstring pouch and port
- Included in pack 9197

## HD Hip Drape with Pouches

Sterile No.	Nonsterile No.	Qty. Cs
59439	59439N	4

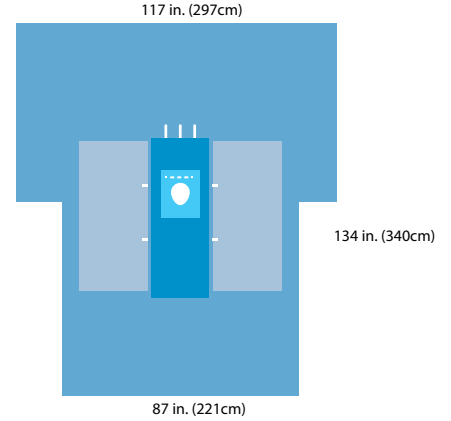

- Heavyweight, premium fabric
- Absorbent reinforcement, 21 x 57 in. (53 x 145cm)
- Fenestration, pear-shaped elastic, 6.75 x 8.25 in. (17 x 21cm)
- Anesthesia screen
- Armboard covers
- Velcro® Cord-Holding Tabs
- Clear leg positioning pouches, 54 x 30 in. (137 x 76cm)

## HD Split Drape

Sterile No.	Nonsterile No.	Qty. Cs
59438	59438N	10

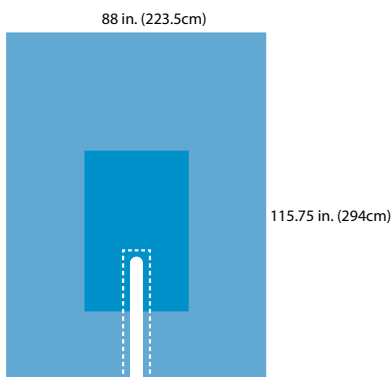

- Heavyweight, premium fabric
- Absorbent reinforcement, 33.5 x 53 in. (79 x 134.5cm)
- Split with adhesive, 4 x 40 in. (10 x 101.5cm)

## HD Top Drape

Sterile No.	Nonsterile No.	Qty. Cs
59352	59352N	10

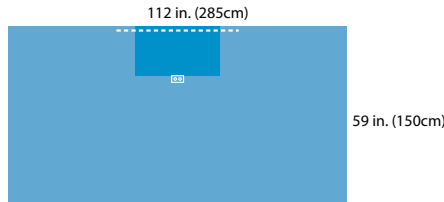

- Heavyweight, premium fabric
- Absorbent reinforcement, 31 x 16.75 in. (79 x 42.5cm)
- Cord-holding tab

## HD Hand Drape

Sterile No.	Nonsterile No.	Qty. Cs
59427	59427N	18

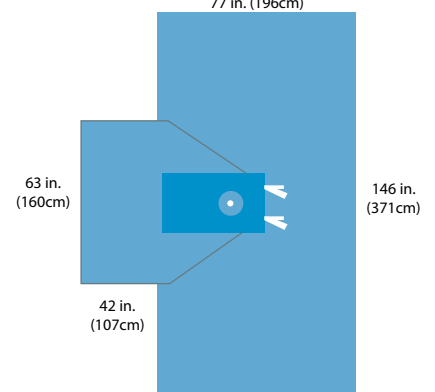

- Heavyweight, premium fabric
- Absorbent reinforcement, 16.75 x 34 in. (42.5 x 89cm)
- Fenestration, circular elastic, 2 in. (5cm).
- Hand table extension
- Velcro® Cord-Holding Tabs

# Orthopedics - Heavy Duty

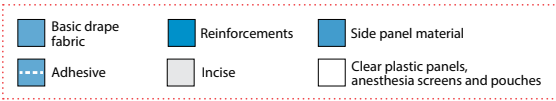

## HD Dual Split Shoulder Drape

Sterile No.	Nonsterile No.	Qty. Cs
59274	59274N	10

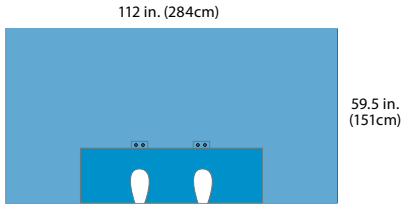

- Heavyweight, premium fabric
- Absorbent reinforcement 20.5 x 48 in. (52 x 122cm)
- Dual 6 x 8 in. (15 x 20cm) split fenestrations with adhesive

## HD Shoulder Drape with Pouch

Sterile No.	Nonsterile No.	Qty. Cs
59362	59362N	10

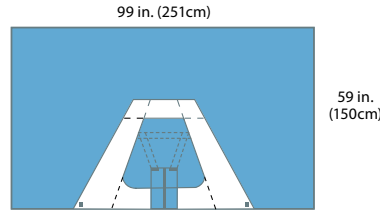

- Heavyweight, premium fabric
- Fenestration, pear-shaped split with adhesive
- Fluid control pouch with malleable wire and two suction ports
- Included in pack 59368

## HD Split Drape

Sterile No.	Nonsterile No.	Qty. Cs
59363	59363N	10

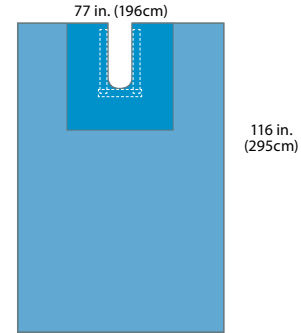

- Heavyweight, premium fabric
- Reinforcement, 40 x 40 in. (101.5 x 101.5cm)
- Split with adhesive, 10 x 25 in. (25.5 x 63.5cm)
- Included in pack 59368

## HD Packs

Nonsterile No.	Description	59180 HD Lower Extremity Pack	9197 HD Arthroscopy Pack	59368 HD Arthroscopy Pack
59405N	HD Extremity Drape	1		
59413N	HD Arthroscopy Drape		1	
59362N	HD Shoulder Drape with Pouch			1
59363N	HD Split Drape			1
90270NA	AAMI 3 NonReinforced Scrub Nurse Gown, Large, with towel and wrap	1	1	
32474N	AAMI 4 Breathable Surgical Gown, X-large, X-long, Specialty	1	1	
8520N	Absorbent towel	1	1	
8474N	Prep U-drape, 60 x 60 in. (152 x 152cm), 6 x 21 in. (15 x 53cm), split	1	1	
8476NA	Prep U-drape, 60 x 72 in. (152 x 183cm), 6 x 21 in. (15 x 53cm), split	1	1	
8694-60	Suture bag	1	1	
8337N	Mayo stand cover, reinforced poly, 23 in. (58cm) wide	1	1	
1582N	Stockinette, 12 x 48 in. (30.5 x 122cm), X-large	1	1	
FG71-2384C	Tubing, 12 ft. x 6 mm	1	1	
3524N	Drape tape	3	3	
8186N	Outer wrap, reinforced poly table cover, 60 x 90 in. (152 x 228.6cm), heavy-duty	1	1	
<b>Quantity per case</b>		<b>6</b>	<b>6</b>	



# Surgical Drapes and Packs

## Orthopedics

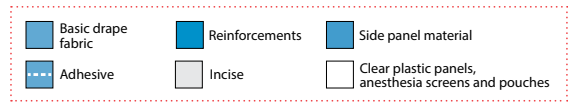

Orthopedics

### Split Drape

Sterile No.	Nonsterile No.	Qty. Cs
29431	29431N	10

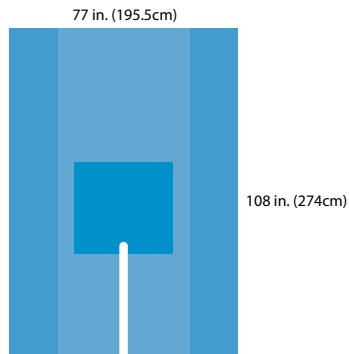

- Absorbent reinforcement, 30.5 x 42 in. (77.5 x 107cm)
- Split without adhesive, 2.5 x 37 in. (6 x 94cm)

### Split Drape

Sterile No.	Nonsterile No.	Qty. Cs
29434	29434N	20

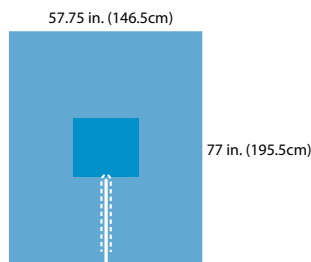

- Absorbent reinforcement, 20 x 18.5 in. (51 x 47cm)
- Split with adhesive, 1 x 28.25 in. (2.5 x 72cm)

### Split Drape

Sterile No.	Nonsterile No.	Qty. Cs
29436	29436N	10

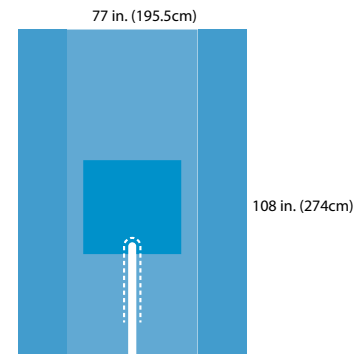

- Absorbent reinforcement, 30.5 x 42 in. (77.5 x 107cm)
- Split with adhesive, 2.5 x 37 in. (6 x 94cm)
- Included in packs 29182

### Split Drape

Sterile No.	Nonsterile No.	Qty. Cs
29440	29440NA	10

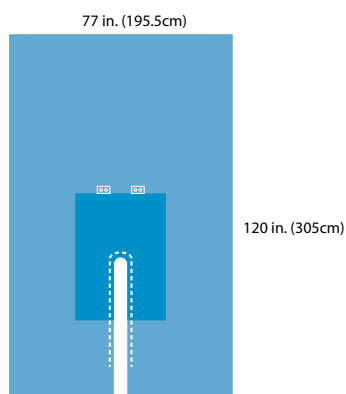

- Absorbent reinforcement, 30.5 x 42 in. (77.5 x 107cm)
- Split with adhesive, 6 x 46 in. (15 x 117cm)
- Cord-holding tabs

### Orthopedic Split Drape

Sterile No.	Nonsterile No.	Qty. Cs
29476	29476N	10

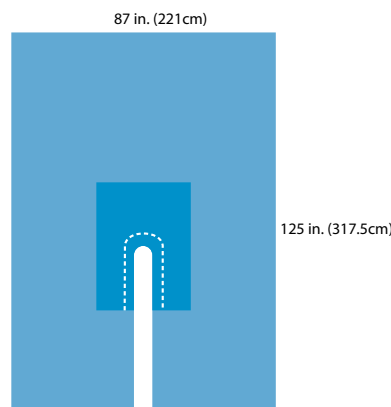

- Absorbent reinforcement, 30.5 x 42 in. (77.5 x 107cm)
- Split with adhesive, 6 x 54 in. (15 x 137cm)

### Split Sheet Drape

Sterile No.	Nonsterile No.	Qty. Cs
29445	29445N	8

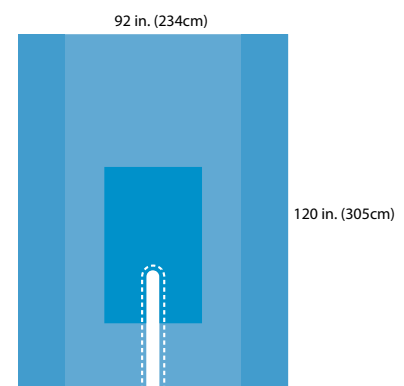

- Absorbent reinforcement, 30.5 x 42 in. (77.5 x 107cm)
- Split with adhesive, 4 x 40 in. (10 x 101cm)

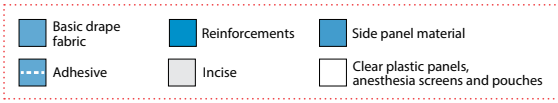

### Split Drape

Sterile No.	Nonsterile No.	Qty. Cs
N/A	9361N	

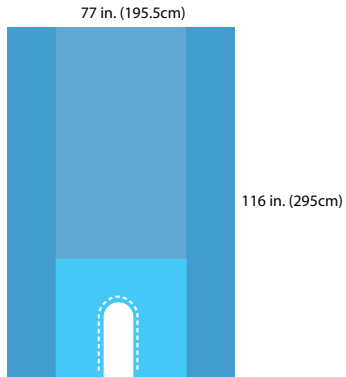

- Reinforcement, 44 x 40 in. (112 x 101.5cm)
- Split with adhesive, 10 x 25 in. (25.5 x 63.5cm)
- Included in packs 9183, 29367, 29365, 29160

### General Ortho Packs

Nonsterile No.	Description	29181 General Orthopedic Pack	29182 Orthopedic Pack
29440N	Split Drape with absorbent reinforcement, adhesive	1	
29351N	Top Drape with absorbent reinforcement, adhesive	1	
9349N	Fan-Folded Drape Sheet, 52 x 76 in. (132 x 193cm)		1
29436N	split drape, adhesive		1
9040N	AAMI 4 Poly Reinforced Surgical Gown, X-Large	2	
8520N	Absorbent towel	2	
8694-60	Suture bag	1	1
8337N	Mayo stand cover, reinforced poly, 23 in. (58cm) wide	1	1
8475N	U-Drape, poly, adhesive, 60 x 84 in. (152 x 213cm), 8 x 30 in. (20 x 76cm) split	1	
8476NA	U-Drape, poly, adhesive, 60 x 72 in. (152 x 183cm), 6 x 21 in. (15 x 53cm) split		1
1582N	Stockinette, 12 x 48 in. (30.5 x 122cm), X-large	1	
8554N	Drape towel, adhesive, nonabsorbent	4	4
8143N	Outer wrap, reinforced poly table cover, 50 x 90 in. (127 x 228.6cm)	1	1
<b>Quantity per case</b>		<b>4</b>	<b>5</b>

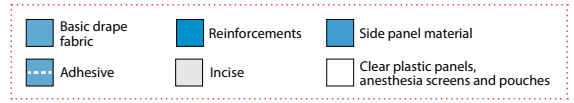

## Arthroscopy Drape for Dropped Leg Procedures

Sterile No.	Nonsterile No.	Qty. Cs
9414	9414NA	12

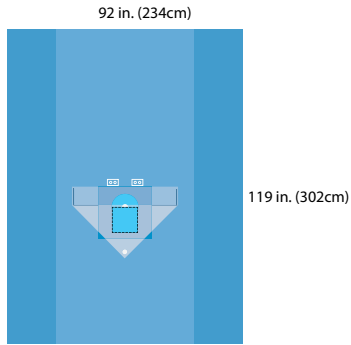

- Absorbent reinforcement, 20 x 20 in. (51 x 51cm)
- Dual fenestration, circular elastic, 2.5 in. (6cm)
- Fluid control pouch with malleable wire and port
- Cord-holding tabs
- Included in pack 9185

## Arthroscopy Drape with Armboard Covers

Sterile No.	Nonsterile No.	Qty. Cs
9423	9423N	12

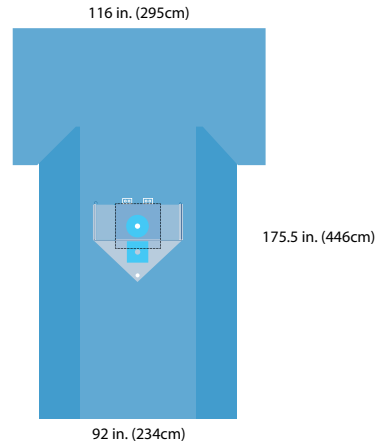

- Reinforcement, 20 x 20 in. (51 x 51cm)
- Dual fenestration, circular elastic, 2.5 in. (6cm)
- Anesthesia screen
- Armboard covers
- Fluid control pouch with malleable wire and port, 40 x 34 in. (101.5 x 88cm)
- Cord-holding tabs

## Hand Drape

Sterile No.	Nonsterile No.	Qty. Cs
29427	29427N	18

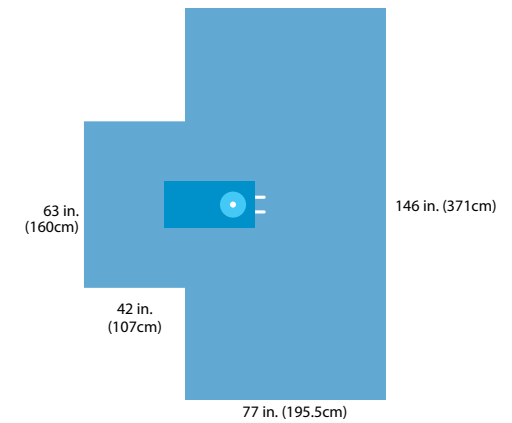

- Absorbent reinforcement, 16.75 x 34 in. (42.5 x 89cm)
- Fenestration, circular elastic, 2 in. (5cm)
- Hand table extension
- Velcro® Cord-Holding Tabs

## Hip Drape

Sterile No.	Nonsterile No.	Qty. Cs
29430	29430N	12

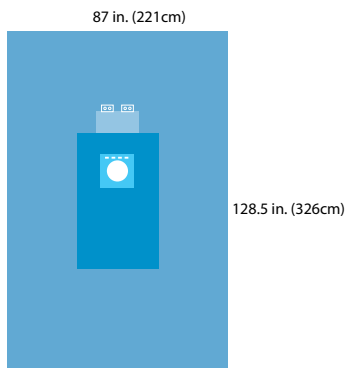

- Absorbent reinforcement, 30.5 x 50 in. (77.5 x 127cm)
- Fenestration, circular elastic, 8 in. (20cm)
- Instrument pad
- Cord-holding tabs
- Included in pack 29187

## Hip Drape with Pouches

Sterile No.	Nonsterile No.	Qty. Cs
29439	29439N	5

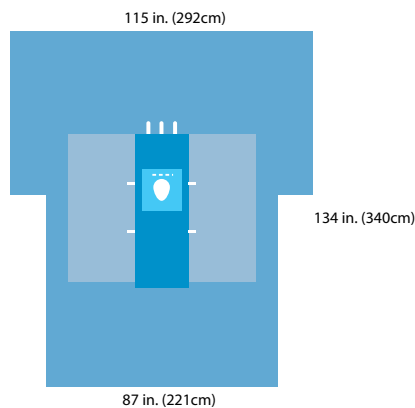

- Absorbent reinforcement, 21.375 x 57 in. (54 x 145cm)
- Fenestration, pear-shaped elastic, 6.75 x 8.25 in. (17 x 21cm)
- Anesthesia screen
- Armboard covers
- Velcro® Cord-Holding Tabs
- Clear leg positioning pouches, 54.5 x 30 in. (138 x 76cm)

## Hip Drape

Sterile No.	Nonsterile No.	Qty. Cs
29444	29444N	5

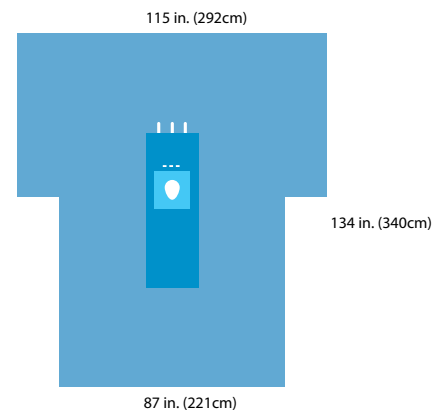

- Absorbent reinforcement, 21.375 x 57 in. (54 x 145cm)
- Fenestration, pear-shaped elastic, 6.75 x 8.25 in. (17 x 21cm)
- Anesthesia screen
- Armboard covers
- Velcro® Cord-Holding Tabs

Arthroscopy Hand and Hip Packs

<b>Nonsterile No.</b>	<b>Description</b>	<b>9419 Hand Pack</b>	<b>29187 Hip Pack</b>	<b>9185 Arthroscopy Pack II for Dropped Leg Procedures</b>
29427N	Hand Drape	1		
29430N	Hip Drape		1	
9414NA	Arthroscopy Drape with pouch for dropped leg procedures			1
9040N	AAMI 4 Poly Reinforced Surgical Gown, X-Large		2	
32474N	AAMI 4 Breathable Surgical Gown,X-large, X-long, Specialty			1
90270NA	AAMI 3 NonReinforced Scrub Nurse Gown, Large, with towel and wrap			1
8520N	Absorbent towel		2	
8694-60	Suture bag	1	1	1
8337N	Mayo Stand Cover, reinforced poly, 23 in. (58cm) wide	1	1	1
8475N	U-Drape, poly, adhesive, 60 x 84 in. (152 x 213cm), 8 x 30 in. (20 x 76.2cm) split		1	
8476NA	Prep U-drape, 60 x 72 in. (152 x 183cm), 6 x 21 in. (15 x 53cm) split	1		2
1582N	Stockinette, 12 x 48 in. (30.5 x 122cm), X-large		1	
1586N	Stockinette, 9 x 48 in. (23 x 122cm), large			1
3524	Drape tape			4
8554N	Drape towel, adhesive, nonabsorbent		2	
8143N	Outer wrap, reinforced poly table cover, 50 x 90 in. (127 x 228.6cm)	1	1	1
	<b>Quantity per case</b>	<b>5</b>	<b>6</b>	<b>6</b>

# Surgical Drapes and Packs

## Orthopedics



Orthopedics

### Extremity Drape

Sterile No.	Nonsterile No.	Qty. Cs
29414	29414N	12

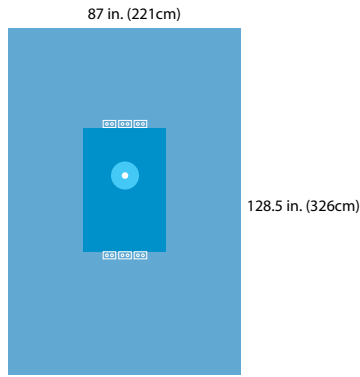

- Absorbent reinforcement, 30.5 x 42 in. (77.5 x 107cm)
- Fenestration, circular elastic, 2.5 in. (6cm)
- Cord-holding tabs
- Included in packs 29188, 29189

### Extremity Drape

Sterile No.	Nonsterile No.	Qty. Cs
29405	29405N	6

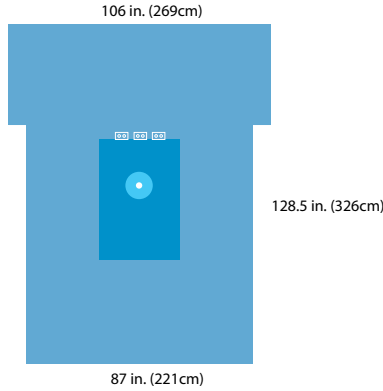

- Absorbent reinforcement, 30.5 x 42 in. (77.5 x 107cm)
- Fenestration, circular elastic, 2.5 in. (6cm)
- Anesthesia screen
- Armboard covers
- Cord-holding tabs

### Extremity Drape with Armboard Covers

Sterile No.	Nonsterile No.	Qty. Cs
29435	29435N	8

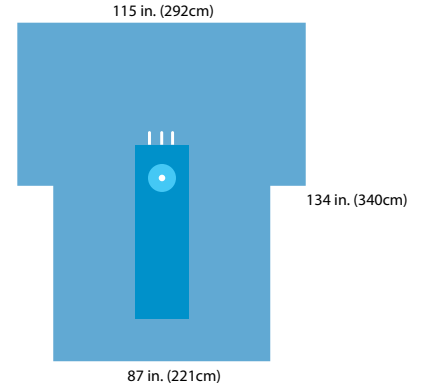

- Absorbent reinforcement, 24 x 66.5 in. (61 x 169cm)
- Fenestration, circular elastic, 2.5 in. (6cm)
- Anesthesia screen
- Armboard covers
- Velcro® Cord-Holding Tabs

### Bilateral Limb Drape

Sterile No.	Nonsterile No.	Qty. Cs
29416	29416N	12

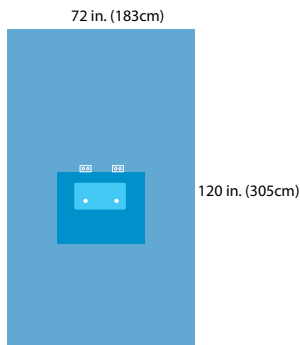

- Absorbent, reinforcement, 31 x 27 in. (79 x 68.5cm)
- Dual fenestration, circular elastic, 1.5 in. (4cm)
- Cord-holding tabs

### Bilateral Limb Drape

Sterile No.	Nonsterile No.	Qty. Cs
29417	29417N	8

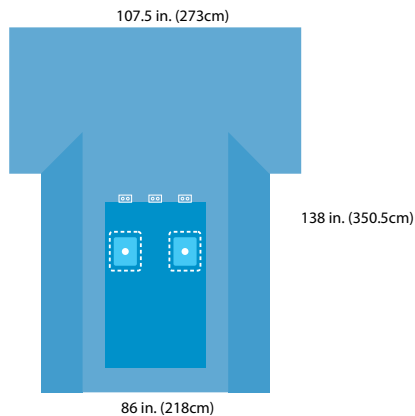

- Absorbent, reinforcement, 37.5 x 61 in. (95 x 155cm)
- Dual fenestration, circular elastic, 2.5 in. (6cm)
- Anesthesia screen
- Armboard covers
- Cord-holding tabs



Extremity Packs

Nonsterile No.	Description	29180 Arthroscopy Pack	29186 Arthroscopy Pack	29188 Fluid	29189 Fluid Control Extremity Pack
29414N	Extremity Drape	1	1	1	1
9040N	AAMI 4 Poly Reinforced Surgical Gown, X-Large	1			2
32474N	AAMI 4 Breathable Surgical Gown,X-large, X-long, Specialty		1		
90270NA	AAMI 3 NonReinforced Scrub Nurse Gown, Large, with towel and wrap		1		
8520N	Absorbent towel	1			1
8694-60	Suture bag	1	1	1	1
8337N	Mayo stand cover, reinforced poly, 23 in. (58cm) wide	1	1	1	1
8476NA	Prep U-drape, 60 x 72 in. (152 x 183cm), 6 x 21 in. (15 x 53cm) split	1	2		
8375N	Plastic sheet, fan-folded, 44 x 60 in. (112 x 152cm)			1	1
1582N	Stockinette, 12 x 48 in. (30.5 x 122cm), X-large	1			
1586N	Stockinette, 9 x 48 in. (23 x 122cm), large		1		
3524	Drape tape		4		
8554N	Drape towel, adhesive, nonabsorbent			2	3
8143N	Outer wrap, reinforced poly table cover, 50 x 90 in. (127 x 228.6cm)	1	1	1	1
<b>Quantity per case</b>		<b>6</b>	<b>6</b>	<b>5</b>	<b>6</b>

# Surgical Drapes and Packs

## Orthopedics

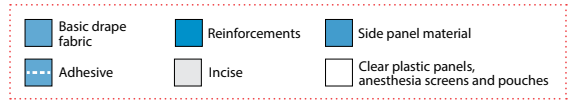

Orthopedics

### Beach Chair Shoulder Drape

Sterile No.	Nonsterile No.	Qty. Cs
29369	29369NA	5

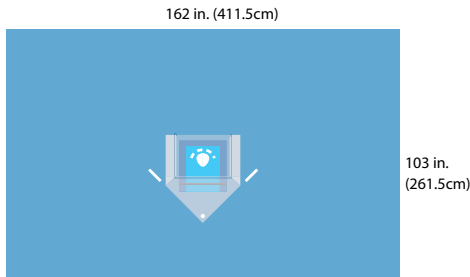

- Fenestration, pear-shaped, 5.5 x 5.75 in. (14 x 14.5cm)
- Fluid control pouch with malleable wire drawstring pouch and port
- Velcro® Cord-Holding Tabs

### Beach Chair Shoulder Drape

Sterile No.	Nonsterile No.	Qty. Cs
29063	29063N	5

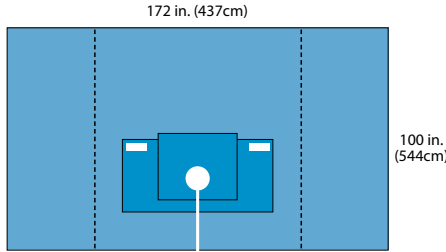

- Circular 10 in. (25 cm) fenestration with 32 in. (81 cm) split
- VELCRO® cord-holding tabs
- Pouch attachment zone

### Beach Chair Shoulder Drape with Attachable Pouch

Sterile No.	Nonsterile No.	Qty. Cs
29066	29066N	5

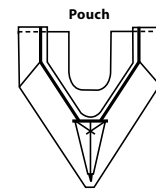
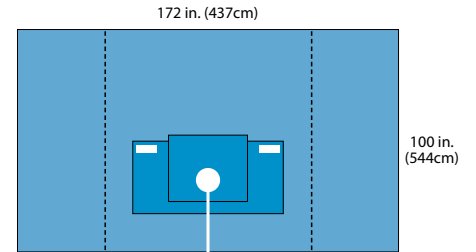

- Circular 10 in. (25 cm) fenestration with 32 in. (81 cm) split
- VELCRO® cord-holding tabs
- Pouch attachment zone
- Includes attachable pouch

### Shoulder Drape

Sterile No.	Nonsterile No.	Qty. Cs
N/A	9360N	

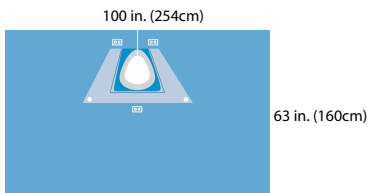

- Fenestration, pear-shaped with split and incise aperture, 11.5 x 14 in. (29 x 35.5cm)
- Fluid control pouch with drawstring and ports
- Cord-holding tabs
- Included in packs 9183, 29367

### Split Drape

Sterile No.	Nonsterile No.	Qty. Cs
N/A	9361N	

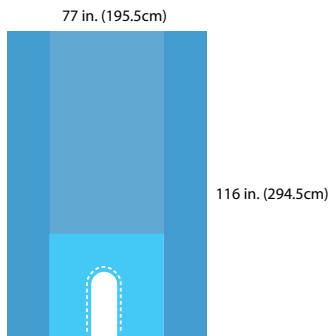

- Reinforcement, 44 x 40 in. (112 x 101.5cm)
- Split with adhesive, 10 x 25 in. (25 x 63.5cm)
- Included in packs 9183, 29367, 29365, 29160

### Shoulder Drape

Sterile No.	Nonsterile No.	Qty. Cs
N/A	29365N	

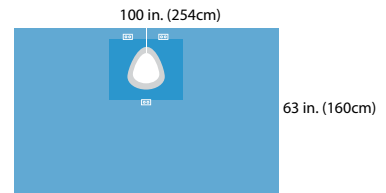

- Absorbent reinforcement, 31 x 22 in. (79 x 56cm)
- Fenestration, pear-shaped with split and incise aperture, 11.5 x 14 in. (29 x 35.5cm)
- Cord-holding tabs
- Included in packs 29365, 29160

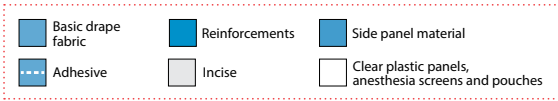

**Top Drape**

Sterile No.	Nonsterile No.	Qty. Cs
29352	29351N	14

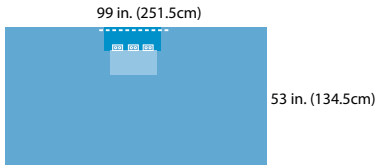

- Absorbent reinforcement, 20 x 9.375 in. (51 x 24cm)
- Cord-holding tabs
- Instrument pad
- Included in packs 29181, 29131

**Top Drape**

Sterile No.	Nonsterile No.	Qty. Cs
N/A	29478N	

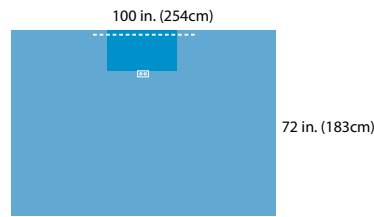

- Absorbent reinforcement, 26 x 15.25 in. (66 x 39cm)
- Cord-holding tabs

**Shoulder Packs**

Nonsterile No.	Description	9183 Fluid Control Shoulder Pack	29367 Fluid Control Shoulder Drape Pack	29365 Shoulder Drape Pack	29160 Shoulder Pack
9360N	Shoulder Drape with attached fluid control pouch, with incise	1	1		
9361N	Split Drape, poly reinforced, adhesive	1	1	1	1
29365N	Shoulder Drape with incise, adhesive			1	1
32474N	AAMI 4 Breathable Surgical Gown,X-large, X-long, Specialty	1			1
90270NA	AAMI 3 NonReinforced Scrub Nurse Gown, Large, with towel and wrap	1			1
8520N	Absorbent towel				1
8694-60	Suture Bag	1			1
8337N	Mayo Stand Cover, reinforced poly, 23 in. (58cm) wide	1			1
8476NA	U-Drape, poly, adhesive, 60 x 72 in. (152 x 183cm), 6 x 21 in. (15 x 53cm) split				1
8554N	Drape towel, adhesive, nonabsorbent	4			4
8146N	Outer wrap, reinforced poly table cover, 44 x 90 in. (112 x 228.6cm)	1			1
<b>Quantity per case</b>		<b>3</b>	<b>10</b>	<b>8</b>	<b>3</b>

# Orthopedics

## Patient Isolation Drape

Sterile No.	Nonsterile No.	Qty. Cs
D1014	D1014NS	5

125 in. (317cm)

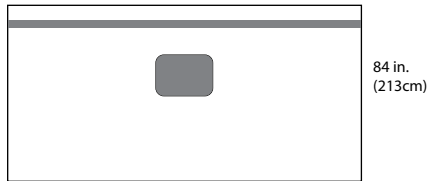

84 in.  
(213cm)

- Adhesive Area: 9.5 x 19.5 in. (24 x 50cm)
- Adhesive Strip: 125 x 0.5 in. (317 x 1.3cm)

## Patient Isolation Drape

Sterile No.	Nonsterile No.	Qty. Cs
D1017	D1017NS	5

125 in. (317cm)

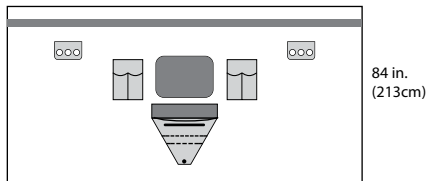

84 in.  
(213cm)

- Adhesive Area  
9.5 x 19.5 in. (24 x 50cm)
- Adhesive Strip  
125 x 0.5 in. (317 x 1.3cm)
- Fluid Pouch  
20 x 19 in. (51 x 48cm)
- Instrument Pouches  
(2) 6.7 x 11.5 in. (17 x 29cm)

## Shoulder Pouch

Sterile No.	Nonsterile No.	Qty. Cs
D1067	D1067NS	5

36 in. (91cm)

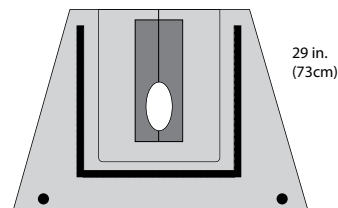

29 in.  
(73cm)

- Adhesive:  
9.5 x 19.5 in. (24 x 50cm)
- Aperture:  
7.5 x 10 in. (19 x 25cm)

PRODUCT KEY:  Adhesive  Matte Film  Clear Film



Surgical Drapes and Packs

# Pacemaker

# Pacemaker

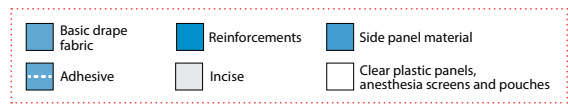

## Pacemaker Drape

Sterile No.	Nonsterile No.	Qty. Cs
29013	29013N	8

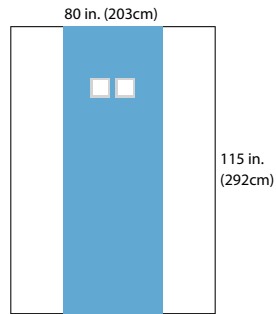

- Absorbent reinforcement, 33.5 x 115 in. (85 x 292cm)
- Fenestration, dual square, 6 in. (15cm), with square incise aperture, 4 in. (10cm)
- Clear side panels

## Pacemaker Drape

Sterile No.	Nonsterile No.	Qty. Cs
D2310C	D2310NSC	30

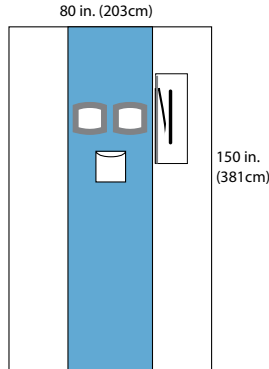

- Absorbent central panel, 29 x 150 in. (74 x 381cm)
- Apertures: 6 x 4 in. (15 x 10cm)
- Clear side panels
- Attachable pouches: 11 x 23 in. (27 x 58cm) 8.5 x 11 in. (21 x 25cm)

## Pacemaker Sheet

Sterile No.	Nonsterile No.	Qty. Cs
N/A	C2325NS*	N/A

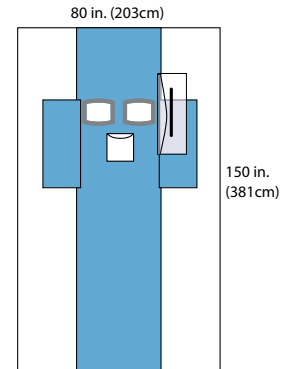

- Absorbent central panel, 29 x 150 in. (74 x 381cm)
- Additional pads: (2) 15 x 30 in. (38.1 x 76.2cm)
- Apertures: 8 x 6 in. (20 x 15cm)
- Clear side panels
- Attachable pouches: 11 x 23 in. (27 x 58cm) 8.5 x 11 in. (21 x 25cm)

## Pacemaker Angiography Sheet

Sterile No.	Nonsterile No.	Qty. Cs
C2362	C2362NS	20

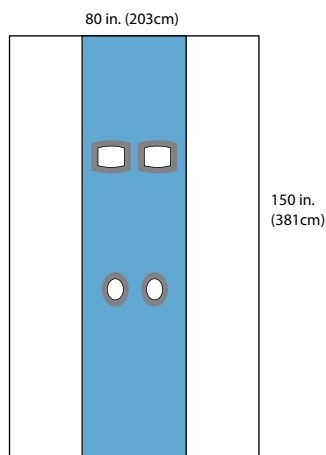

- Absorbent central panel, 29 x 150 in. (74 x 381cm)
- Rectangular apertures: 6 x 4 in. (15 x 20cm)
- Oval apertures: 3.5 x 4.5 in. (9 x 11cm)
- Clear side panels

## Pacemaker Sheet

Sterile No.	Nonsterile No.	Qty. Cs
C2319*	C2319NS*	20

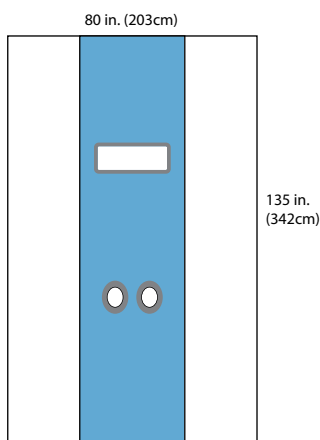

- Absorbent central panel, 29 x 135 in. (74 x 342cm)
- Rectangular aperture: 16 x 6 in. (41 x 15cm)
- Oval apertures: 3.5 x 4.5 in. (9 x 11cm)
- Clear side panels

## Pacemaker Drape

Sterile No.	Nonsterile No.	Qty. Cs
C2304*	C2304NS*	20

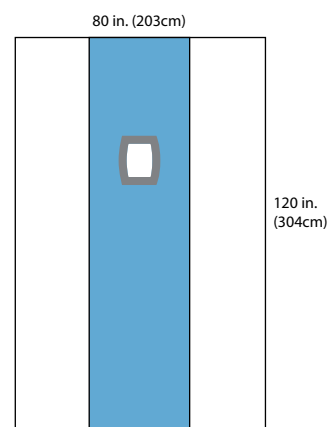

- Absorbent central panel, 29 x 120 in (74 x 304cm)
- Aperture: 6 x 8 in. (15 x 20cm)
- Clear side panels

\* Denotes a 6-8 week lead time



## Fluoroscope Procedure Sheet

Sterile No.	Nonsterile No.	Qty. Cs
D2221	D2221NS 80 in. (203cm)	20

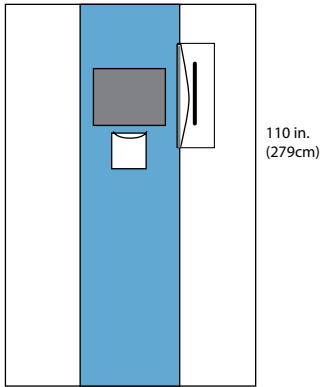

- Absorbent central panel, 29 x 110 in. (74 x 279cm)
- Adhesive area: 19.75 x 14 in. (43 x 33cm)
- Clear side panels
- Attachable pouches: 11 x 23 in. (27 x 58cm) 8.5 x 11 in. (21 x 25cm)



Surgical Drapes and Packs

# Pediatrics



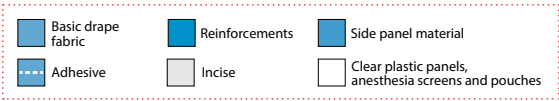

### Pediatric Drape

Sterile No.	Nonsterile No.	Qty. Cs
29492	29492N	10

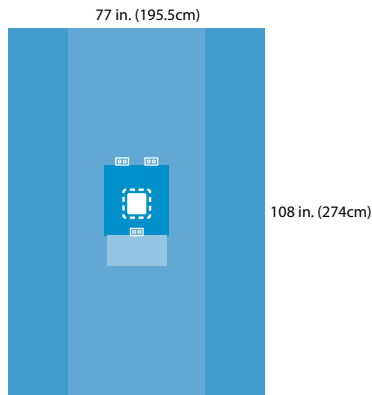

- Absorbent reinforcement, 19 x 20.375 in. (48 x 52cm)
- Fenestration, 6 x 6 in. (15 x 15cm)
- Instrument pad
- Cord-holding tabs

### Minor Procedure Drape

Sterile No.	Nonsterile No.	Qty. Cs
29496	29496N	10

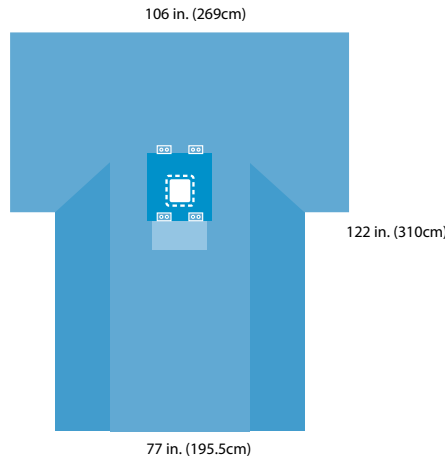

- Absorbent reinforcement, 19 x 19 in. (48 x 48cm)
- Fenestration, 6 x 6 in. (15 x 15cm)
- Armboard covers
- Instrument pad
- Cord-holding tabs

### Neonatal Drape

Sterile No.	Nonsterile No.	Qty. Cs
29494	29494N	20

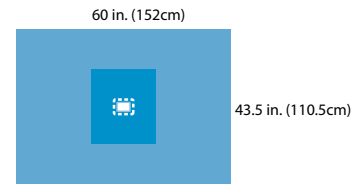

- Absorbent reinforcement, 18 x 20 in. (46 x 51cm)
- Fenestration, 3 x 4 in. (7.5 x 10cm)

### Neonatal Drape

Sterile No.	Nonsterile No.	Qty. Cs
9133	N/A	15

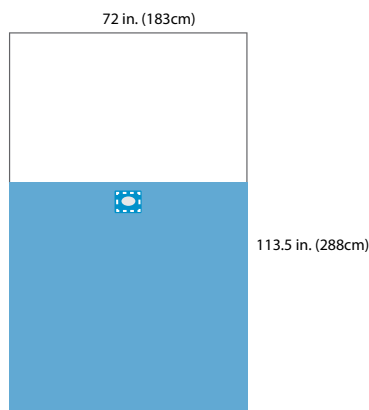

- Film, 10 x 8 in. (25 x 20cm)
- Clear anesthesia screen
- Drapeable blue poly film base material
- Fenestration, oval, 2 x 4 in. (5 x 10cm)

### Split Drape

Sterile No.	Nonsterile No.	Qty. Cs
29434	29434N	20

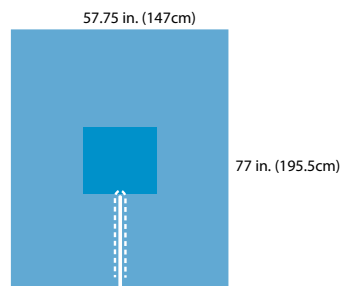

- Absorbent reinforcement, 20.375 x 18.5 in. (52 x 47cm)
- Split with adhesive, 1 x 28.25 in. (2.5 x 72cm)

### Circumcision Drape

Sterile No.	Nonsterile No.	Qty. Cs
74210	74210N	160

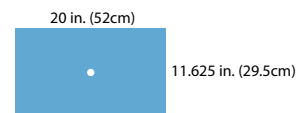

- Fenestration, circular, 0.625 in. (29.5cm)

### Pediatric Directional Incision Drape

Sterile No.	Nonsterile No.	Qty. Cs
9777	9777N	60

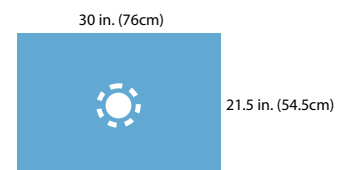

- Fenestration, circular, 4 in. (10cm)

# Pediatrics

## Pediatric Pack

Nonsterile No.	Description	29490 Pediatric Pack
29496N	Minor Procedure Drape	1
9545NA	AAMI 3 NonReinforced Surgical Gown, X-Large	2
8520N	Absorbent towel	2
8337N	Mayo stand cover, reinforced poly, 23 in. (58cm) wide	1
8694-60	Suture bag	1
8554N	Drape towel, adhesive, nonabsorbent	4
8146N	Outer wrap, reinforced poly table cover, 44 x 90 in. (112 x 228.6cm)	1
<b>Quantity per case</b>		<b>8</b>



Surgical Drapes and Packs

# Peri-GYN

## Surgical Drapes and Packs

# Peri-GYN

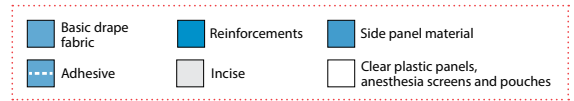

### Abdominal Lithotomy Drape

Sterile No.	Nonsterile No.	Qty. Cs
N/A	29300N	

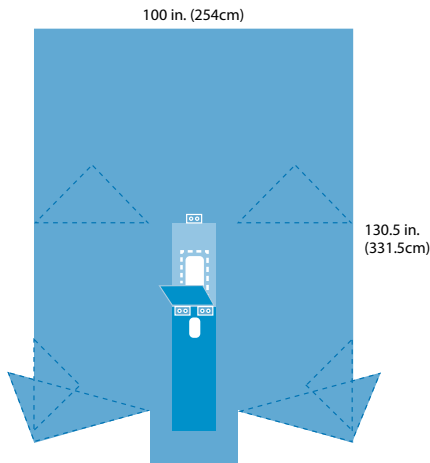

- Absorbent reinforcement, 13.375 x 29 in. (34 x 74cm)
- Fenestration, abdominal with adhesive, 5.6875 x 12.125 in. (14 x 31cm)
- Fenestration, perineal, 3 x 6 in. (7.5 x 15cm)
- Perineal flap
- Attached leggings
- Cord-holding tabs
- Included in pack 29146

### Laparoscopy Drape

Sterile No.	Nonsterile No.	Qty. Cs
N/A	29402N	

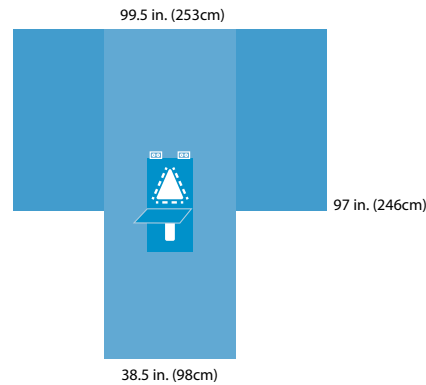

- Absorbent reinforcement, 15.25 x 30 in. (39 x 76cm)
- Fenestration, triangular abdominal with adhesive, 7.875 x 8.75 in. (20 x 22cm)
- Fenestration, perineal, 3 x 6 in. (7.5 x 15cm)
- Perineal flap
- Cord-holding tabs
- Included in pack 29242, 29245

### Laparoscopy/ Pelviscopy Drape

Sterile No.	Nonsterile No.	Qty. Cs
N/A	29404N	

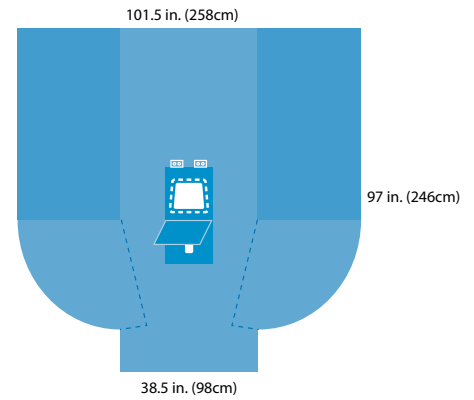

- Absorbent reinforcement, 15.375 x 27 in. (39 x 68.5cm)
- Fenestration, trapezoidal abdominal with adhesive, 7 x 7 x 9 in. (18 x 18 x 23cm)
- Fenestration, perineal, 3 x 6 in. (7.5 x 15cm)
- Perineal flap
- Side gussets for added coverage
- Cord-holding tabs
- Included in pack 29606, 29604

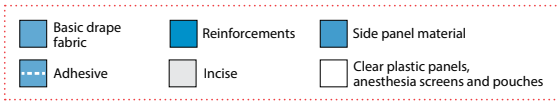

### Laparoscopy/ Pelviscopy Drape

Sterile No.	Nonsterile No.	Qty. Cs
29407	29407N	10

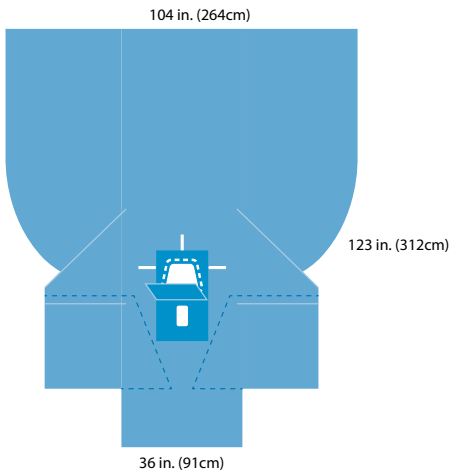

- Absorbent reinforcement, 15.25 x 26.5 in. (39 x 67cm)
- Fenestration, abdominal with adhesive, 7 x 7 x 7 x 9 in. (18 x 18 x 23cm)
- Fenestration, perineal, 3 x 6 in. (7.5 x 15cm)
- Perineal flap
- Armboard covers
- Velcro® Cord-Holding Straps
- Included in pack 29408

### Laparoscopy Drape

Sterile No.	Nonsterile No.	Qty. Cs
N/A	29403N	

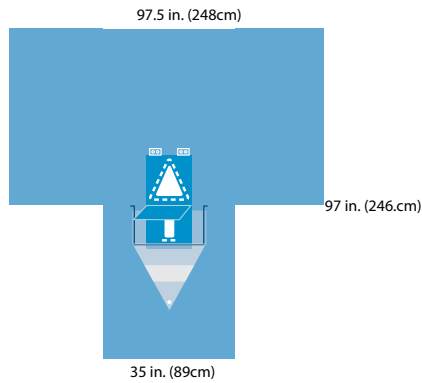

- Absorbent reinforcement, 15.375 x 27 in. (39 x 67cm)
- Triangular abdominal fenestration with adhesive, 7.875 x 8.75 in. (20 x 22cm)
- Fenestration, perineal, with adhesive, 3 x 6 in. (7.5 x 15cm)
- Perineal flap
- Fluid control pouch with filtering screen, closed suction port and drawstring
- Cord-holding tabs
- Included in pack 29503

### Lithotomy Drape

Sterile No.	Nonsterile No.	Qty. Cs
29455	29455N	8

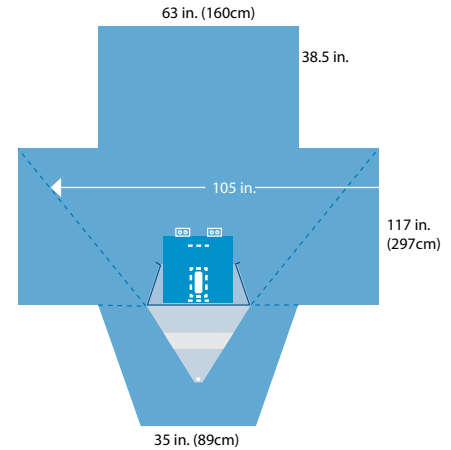

- Absorbent reinforcement, 20.375 x 19 in. (52 x 48 cm)
- Fenestration, perineal, with adhesive, 2.5 x 6.5 in. (6 x 16.5cm)
- Anesthesia screen
- Attached leggings
- Cord-holding tabs
- Fluid control pouch with filtering screen and suction port

# Surgical Drapes and Packs

## Peri-GYN



Peri-GYN

### Lithotomy "T" Drape

Sterile No.	Nonsterile No.	Qty. Cs
N/A	29438N	

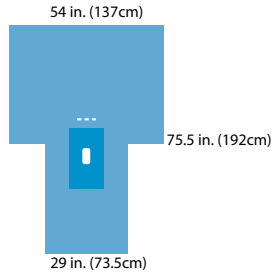

- Absorbent reinforcement, 12 x 20.375 in. (30.5 x 52cm)
- Fenestration, perineal, 2.5 x 5.5 in. (6 x 14cm)
- Included in pack 29276

### Lithotomy Drape

Sterile No.	Nonsterile No.	Qty. Cs
29450	29450N	10

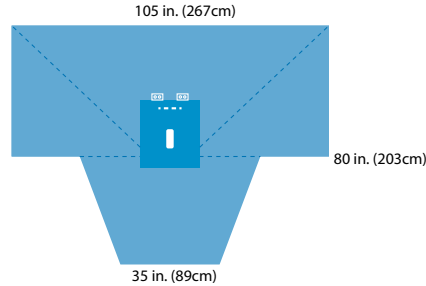

- Absorbent reinforcement, 20.375 x 22 in. (52 x 56 cm)
- Fenestration, perineal, 2.5 x 6.5 in. (6 x 16.5cm)
- Attached leggings
- Cord-holding tabs
- Included in pack 29170, 29171

### LAVH Drape

Sterile No.	Nonsterile No.	Qty. Cs
29474	29474N	8

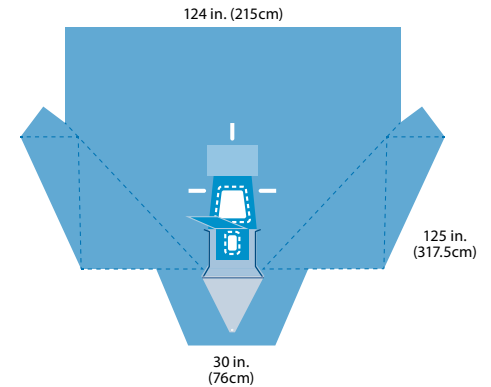

- Absorbent reinforcement, 12 x 19.25 x 16.75 in. (30.5 x 49 x 42.5cm)
- Trapezoidal abdominal fenestration with adhesive, 7 x 9 x 9 in. (18 x 23 x 23cm)
- Fenestration, perineal, with adhesive, 3 x 6 in. (7.5 x 15cm)
- Perineal flap
- Anesthesia screen
- Armboard covers
- Attached leggings with tieback straps
- Fluid control pouch with closed suction port and drawstring
- Instrument pad
- Velcro® Cord-Holding Tabs
- Included in pack 29475

### Robotic Drape with Attached Leggings

Sterile No.	Nonsterile No.	Qty. Cs
29574	29574N	8

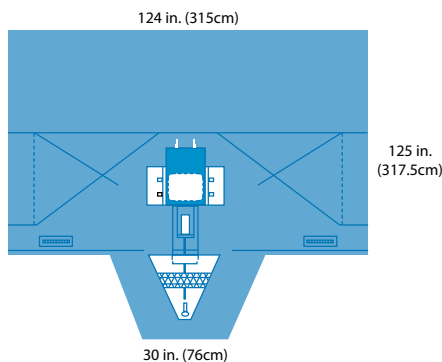

- Absorbent reinforcement 36.5 x 20.25 in (92.7 x 51.4 cm)
- Abdominal fenestration with adhesive, 14 x 11 in. (35.5 x 28cm)
- Perineal fenestration with adhesive, 3 x 6 in. (7.5 x 15cm)
- Perineal flap
- Attached leggings
- Fluid control pouch with filtering screen and port
- Instrument pouches 9 x 20 in (23 x 51 cm)

### Robotic Drape

Sterile No.	Nonsterile No.	Qty. Cs
29575	29575N	10

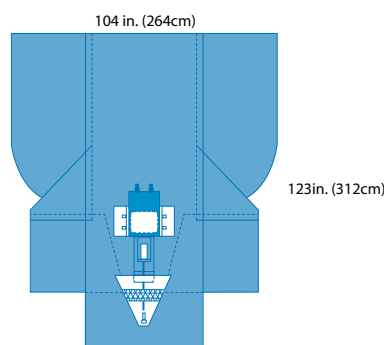

- Absorbent reinforcement 36.5 x 20.25 in (92.7 x 51.4 cm)
- Abdominal fenestration with adhesive, 14 x 11 in. (35.5 x 28cm)
- Perineal fenestration with adhesive, 3 x 6 in. (7.5 x 15cm)
- Perineal flap
- Fluid control pouch with filtering screen and port
- Instrument pouches 9 x 20 in (23 x 51 cm)

Peri-GYN Packs

Nonsterile No.	Description	29242Laparoscopy Pack	29245Laparoscopy Pack	29606Laparoscopy/Pelviscopy Pack I	29604Laparoscopy/Pelviscopy Pack II	29408Laparoscopy/Pelviscopy Pack III	29503Fluid Control Laparoscopy Pack	29146Abdominal Lithotomy Pack	29276Peri-GYN Pack	29170Peri-GYN Pack	29171Peri-GYN Pack	29475LAVH/Laparoscopy Pack	9165Peri-GYN Pack	9274Peri-GYN Pack
29438N	Lithotomy "T" Drape with absorbent reinforcement, adhesive								1					
29450N	Lithotomy Drape with absorbent reinforcement, attached leggings									1	1			
29474N	LAVH Drape											1		
29402N	Laparoscopy Drape with absorbent reinforcement, adhesive	1	1											
29404N	Laparoscopy/Pelviscopy Drape with gussets, absorbent reinforcement, adhesive			1	1									
29407N	Laparotomy/Pelviscopy Drape					1								
29403N	Laparoscopy Drape						1							
29300N	Abdominal lithotomy drape							1						
9359N	Drape sheet, adhesive												1	1
8483N	Under-buttocks drape, reinforced poly		1	1	1	1		1		1	1	1	1	1
90680NA	AAMI 4 Poly Reinforced Scrub Nurse Gown, Large											1		
9040N	AAMI 4 Poly Reinforced Surgical Gown, X-Large											2		
90270NA	AAMI 3 NonReinforced Scrub Nurse Gown, Large, with towel and wrap		1											
9515NA	AAMI 3 NonReinforced Surgical Gown, Large		1								1			1
8554N	Drape towel, adhesive, nonabsorbent	1	1		2	2			1	1	1		1	1
8520N	Absorbent towel	1	1						1	1	1		1	1
8421N	Pair of leggings, X-large	1	1	1	1	1	1		1				1	1
8694-60	Suture bag	1	1		1	1			1	1	1	1	1	1
8337N	Mayo Stand Cover, reinforced poly, 23 in. (58cm) wide		1		1	1						1		
8146N	Outer wrap, reinforced poly table cover, 44 x 90 in. (111.8 x 228cm)	1	1		1	1			1				1	1
8149N	Outer wrap, reinforced poly table cover, 44 x 85 in. (111.8 x 216cm), reinforcement 24 x 85 in. (61 x 216cm)									1	1			
8143N	Outer wrap, reinforced poly table cover, 50 x 90 in. (127 x 228cm)											1		
	<b>Quantity per case</b>	<b>10</b>	<b>8</b>	<b>10</b>	<b>10</b>	<b>10</b>	<b>10</b>	<b>8</b>	<b>10</b>	<b>12</b>	<b>5</b>	<b>4</b>	<b>12</b>	<b>10</b>





Surgical Drapes and Packs

# Special procedures



# Surgical Drapes and Packs

## Special procedures



### Minor Procedure Drape

Sterile No.	Nonsterile No.	Qty. Cs
D1092	D1092NS	25

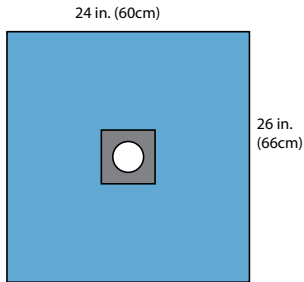

- Aperture: 2.5 in. dia. (6cm dia.)

### Small Aperture Drape

Sterile No.	Nonsterile No.	Qty. Cs
C2299*	C2299NS	20

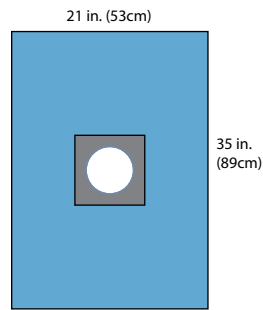

- Absorbent drape material
- Aperture: 5 in. dia. (13cm dia.)

### Epidural Drape

Sterile No.	Nonsterile No.	Qty. Cs
C2348*	N/A	20

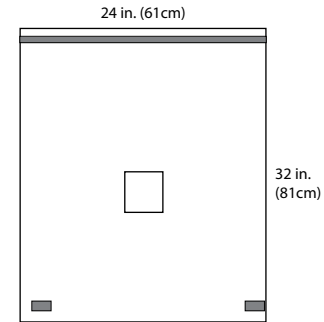

- Aperture: 4 x 4 in. (10 x 10cm)
- Adhesive strip: 24 x 1 in. (61 x 1cm)
- Adhesive tabs: (2) 2 x 1 in. (5 x 2.5cm)

### Special Procedure Sheet

Sterile No.	Nonsterile No.	Qty. Cs
D2224	D2224NS	20

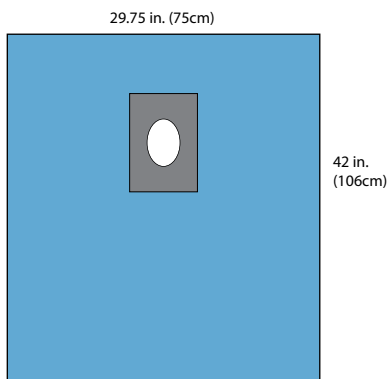

- Absorbent drape material
- Adhesive areas: 8.25 x 10 in. (20 x 15cm)
- Aperture: 3.5 x 4.5 in (8 cm x 11 cm)

### Special Procedure Drape

Sterile No.	Nonsterile No.	Qty. Cs
C2289*	N/A	20

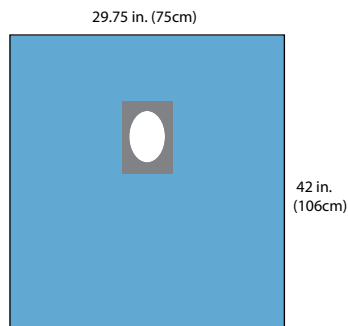

- Absorbent drape material
- Aperture: 4.75 x 6.5 in (12 x 16cm)

### Epidural Drape

Sterile No.	Nonsterile No.	Qty. Cs
C2358*	N/A	20

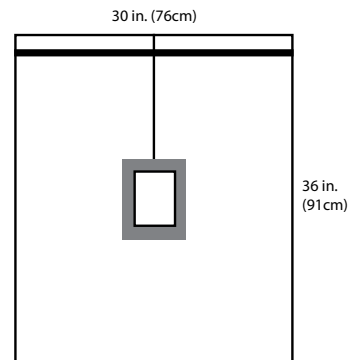

- Aperture: 4 x 6 in (10 x 15cm)
- Adhesive strip: 30 x 1 in. (76cm x 2.5cm)

\* Denotes a 6-8 week lead time

# Special Procedures

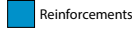
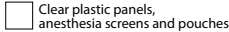
 Basic drape fabric	 Reinforcements	 Side panel material
 Adhesive	 Incise	 Clear plastic panels, anesthesia screens and pouches

## Fistula Drape

Sterile No.	Nonsterile No.	Qty. Cs
D2264	D2264NS	10

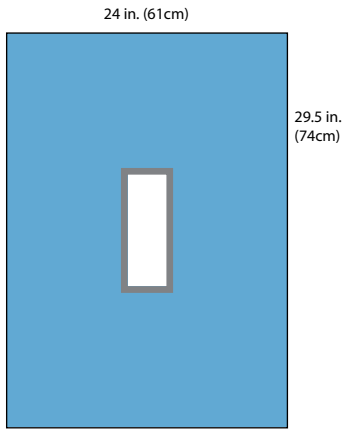

- Absorbent drape material
- Aperture: 3 x 9 in. (8 x 23cm)

## Fistula Drape with Window

Sterile No.	Nonsterile No.	Qty. Cs
N/A	C2290NS*	N/A

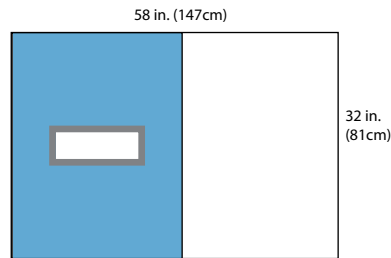

- Absorbent drape material and clear film
- Aperture: 9 x 3 in. (23 x 8cm)

## Fistula Sheet

Sterile No.	Nonsterile No.	Qty. Cs
D2318C	D2318NSC	20

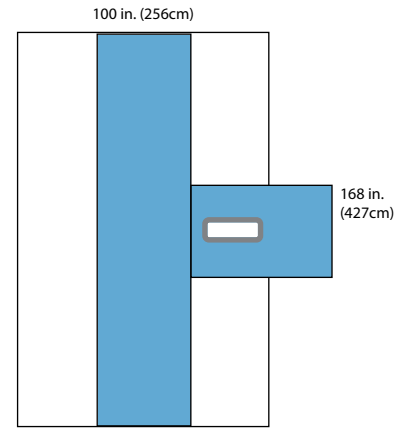

- Absorbent central panel, 29 x 168 in. (74 x 427cm)
- Aperture: 9 x 3 in. (23 x 8cm)
- Clear side panels

\* Denotes a 6-8 week lead time



Surgical Drapes and Packs

# Standard packs

# Standard packs

## Setup Packs

### Setup Pack Sterile No. 114

NS Cat. No.	Contents	Qty. Cs12
8694-60	1 Suture bag	
8337N	1 Mayo stand cover, reinforced poly, 23 in. (58cm) wide	
8146N	1 Outer wrap, reinforced poly table cover, 44 x 90 in. (111.8 x 228.6cm)	

### Setup Pack Sterile No. 117

NS Cat. No.	Contents	Qty. Cs13
8694-60	1 Suture bag	
8337N	1 Mayo stand cover, reinforced poly, 23 in. (58cm) wide	
8554N	4 Drape towel, adhesive, nonabsorbent	
8143N	1 Outer wrap, reinforced poly table cover, 50 x 90 in. (127 x 228.6cm)	

### Setup Pack Sterile No. 9102

NS Cat. No.	Contents	Qty. Cs12
8694-60	1 Suture bag	
8337N	1 Mayo stand cover, reinforced poly, 23 in. (58cm) wide	
8186N	1 Outer wrap, reinforced poly table cover, 60 x 90 in. (165.1 x 228.6cm), heavy duty	

## General Surgery

### Basic Pack Sterile No. 9100

NS Cat. No.	Contents	Qty. Cs12
8694-60	1 Suture bag	
8337N	1 Mayo stand cover, reinforced poly, 23 in. (58cm) wide	
8554N	4 Drape towel, adhesive, nonabsorbent	
9358N	1 Fan-Folded Drape Sheet, 40 x 57 in. (101 x 145cm)	
9349N	1 Fan-Folded Drape Sheet, 52 x 76 in. (132 x 193cm)	
8146N	1 Outer wrap, reinforced poly table cover, 44 x 90 in. (111.8 x 228.6cm)	

### Basic Pack Sterile No. 9101

NS Cat. No.	Contents	Qty. Cs5
8694-60	1 Suture bag	
8337N	1 Mayo stand cover, reinforced poly, 23 in. (58cm) wide	
90270NA	1 AAMI 3 NonReinforced Scrub Nurse Gown, Large, with towel and wrap	
9515NA	1 AAMI 3 NonReinforced Surgical Gown, Large	
8146N	1 Outer wrap, reinforced poly table cover, 44 x 90 in. (111.8 x 228.6cm)	

## General Surgery

### Basic Pack Sterile No. 9103

NS Cat. No.	Contents	Qty. Cs8
8694-60	1 Suture bag	
8337N	1 Mayo stand cover, reinforced poly, 23 in. (58cm) wide	
8554N	4 Drape towel, adhesive, nonabsorbent	
9358N	1 Fan-Folded Drape Sheet, 40 x 57 in. (101 x 145cm)	
9349N	1 Fan-Folded Drape Sheet, 52 x 76 in. (132 x 193cm)	
90270NA	1 AAMI 3 NonReinforced Scrub Nurse Gown, Large, with towel and wrap	
9515NA	1 AAMI 3 NonReinforced Surgical Gown, Large	
8146N	1 Outer wrap, reinforced poly table cover, 44 x 90 in. (111.8 x 228.6cm)	

### Basic Pack Sterile No. 9111

NS Cat. No.	Contents	Qty. Cs5
8694-60	1 Suture bag	
8337N	1 Mayo stand cover, reinforced poly, 23 in. (58cm) wide	
8554N	4 Drape towel, adhesive, nonabsorbent	
9349N	1 Fan-Folded Drape Sheet, 52 x 76 in. (132 x 193cm)	
90970N	1 AAMI 3 Fabric Reinforced Scrub Nurse Gown, Large, with towel and wrap	
9511N	1 AAMI 3 Fabric Reinforced Surgical Gown, Large	
8146N	1 Outer wrap, reinforced poly table cover, 44 x 90 in. (111.8 x 228.6cm)	
8520N	1 Absorbent towel	

### Basic Pack Sterile No. 9112

NS Cat. No.	Contents	Qty. Cs10
8694-60	1 Suture bag	
8337N	1 Mayo stand cover, reinforced poly, 23 in. (58cm) wide	
8554N	4 Drape towel, adhesive, nonabsorbent	
9349N	1 Fan-Folded Drape Sheet, 52 x 76 in. (132 x 193cm)	
8146N	1 Outer wrap, reinforced poly table cover, 44 x 90 in. (111.8 x 228.6cm)	

### Basic Pack Sterile No. 9113

NS Cat. No.	Contents	Qty. Cs5
8694-60	1 Suture bag	
8337N	1 Mayo stand cover, reinforced poly, 23 in. (58cm) wide	
8554N	4 Drape towel, adhesive, nonabsorbent	
9349N	1 Fan-Folded Drape Sheet, 52 x 76 in. (132 x 193cm)	
90270NA	1 AAMI 3 NonReinforced Scrub Nurse Gown, Large, with towel and wrap	
9515NA	1 AAMI 3 NonReinforced Surgical Gown, Large	
8146N	1 Outer wrap, reinforced poly table cover, 44 x 90 in. (111.8 x 228.6cm)	
8520N	1 Absorbent towel	

# Standard packs

## General Surgery

### Basic Pack Sterile No. 9114

NS Cat. No.	Contents	Qty. Cs5
8520N	1 Absorbent towel	
8694-60	1 Suture bag	
8337N	1 Mayo stand cover, reinforced poly, 23 in. (58cm) wide	
8554N	4 Drape towel, adhesive, nonabsorbent	
9349N	1 Fan-Folded Drape Sheet, 52 x 76 in. (132 x 193cm)	
8143N	1 Outer wrap, reinforced poly table cover, 44 x 90 in. (127 x 228.6cm)	
9010N	1 AAMI 4 Poly Reinforced Surgical Gown, Large	
90680NA	1 AAMI 4 Poly Reinforced Scrub Nurse Gown, Large	

### Basic Pack Sterile No. 9131

NS Cat. No.	Contents	Qty. Cs7
8694-60	1 Suture bag	
8337N	1 Mayo stand cover, reinforced poly, 23 in. (58cm) wide	
90270NA	1 AAMI 3 NonReinforced Scrub Nurse Gown, Large, with towel and wrap	
9515NA	1 AAMI 3 NonReinforced Surgical Gown, Large	
8186N	1 Outer wrap, reinforced poly table cover, 65 x 90 in. (165.1 x 228.6cm), heavy duty	

## Universal Packs

### Universal Pack Sterile No. 9106

NS Cat. No.	Contents	Qty. Cs5
9465N	2 Side Drape, adhesive	
9468N	1 Foot Drape, adhesive	
9467N	1 Head Drape, adhesive	
8520N	1 Absorbent towel	
8337N	1 Mayo stand cover, reinforced poly, 23 in. (58cm) wide	
8694-60	1 Suture bag	
8146N	1 Outer wrap, reinforced poly table cover, 44 x 90 in. (111.8 x 228.6cm)	

### Universal Pack Sterile No. 29107

NS Cat. No.	Contents	Qty. Cs6
29465NA	2 Side Drape with tape	
29469N	1 Foot Drape	
29467N	1 Head Drape with reinforcement	
90270NA	1 AAMI 3 NonReinforced Scrub Nurse Gown, Large, with towel and wrap	
9515NA	1 AAMI 3 NonReinforced Surgical Gown, Large	
8520N	1 Absorbent towel	
8554N	4 Drape towel, adhesive, nonabsorbent	
8337N	1 Mayo stand cover, reinforced poly, 23 in. (58cm) wide	
8694-60	1 Suture bag	
8146N	1 Outer wrap, reinforced poly table cover, 44 x 90 in. (111.8 x 228.6cm)	

## Universal Packs

### Universal Pack Sterile No. 29118

NS Cat. No.	Contents	Qty. Cs 6
29669N	1 Foot Drape with adhesive, 77 x 75 in. (195.6 x 190.5cm)	
29667N	1 Head Drape with adhesive, 72 x 112 in. (182.9 x 284.5cm)	
29665N	2 Side Drape with tape, 44 x 77 in. (111.8 x 195.6cm)	
8554N	4 Drape towel, adhesive, nonabsorbent	
8337N	1 Mayo stand cover, reinforced poly, 23 in.(58cm) wide	
8694-60	1 Suture bag	
8146N	1 Outer wrap, reinforced poly table cover, 44 x 90 in. (111.8 x 228.6cm)	
8520N	1 Absorbent towel	

### Universal Split Pack Sterile No. 29131

NS Cat. No.	Contents	Qty. Cs4
29440NA	1 Split Drape with absorbent reinforcement	
29351N	1 Top Drape, absorbent reinforcement/instrument pad 53 x 99 in. (134.6 x 251.5cm)	
8554N	4 Drape towel, adhesive, nonabsorbent	
8337N	1 Mayo stand cover, reinforced poly, 23 in. (58cm) wide	
8694-60	1 Suture bag	
8143N	1 Outer wrap, reinforced poly table cover, 50 x 90 in. (127 x 228.6cm)	

### Universal Split Pack II Sterile No. 29133

NS Cat. No.	Contents	Qty. Cs10
29194N	1 Chest/Breast U-Drape with 29 x 39 in. (73.7 x 99.1cm) absorbent reinforcement, 12 x 30.5 in. (30.5 x 77.5cm), split	
29195N	1 Bar Sheet with armboard covers	
8554N	4 Drape towel, adhesive, nonabsorbent	
8337N	1 Mayo stand cover, reinforced poly, 23 in. (58cm) wide	
8694-60	1 Suture bag	
8143N	1 Outer wrap, reinforced poly table cover, 50 x 90 in. (127 x 228.6cm)	

## Laparotomy Packs

### Laparotomy Pack Sterile No. 29127

NS Cat. No.	Contents	Qty. Cs6
9358N	2 Fan-Folded Drape Sheet, 40 x 57 in. (101 x 145cm)	
29410N	1 Laparotomy Drape with absorbent reinforcement and armboard covers	
9511N	2 AAMI 3 Fabric Reinforced Surgical Gown, Large	
8554N	4 Drape towel, adhesive, nonabsorbent	
8520N	3 Absorbent towel	
8337N	1 Mayo stand cover, reinforced poly, 23 in. (58cm) wide	
8694-60	1 Suture bag	
8146N	1 Outer wrap, reinforced poly table cover, 44 x 90 in. (111.8 x 228.6cm)	

# Standard packs

## Laparotomy Packs

### Laparotomy Pack Sterile No. 29130

NS Cat. No.	Contents	Qty. Cs4
29410N	1 Laparotomy Drape with absorbent reinforcement and armboard covers	
90680NA	1 AAMI 4 Poly Reinforced Scrub Nurse Gown, Large	
9010N	1 AAMI 4 Poly Reinforced Surgical Gown, Large	
8554N	4 Drape towel, adhesive, nonabsorbent	
8520N	1 Absorbent towel	
8337N	1 Mayo stand cover, reinforced poly, 23 in. (58cm) wide	
8694-60	1 Suture bag	
8143N	1 Outer wrap, reinforced poly table cover, 50 x 90 in. (127 x 228.6cm)	

### Laparotomy Pack Sterile No. 29137

NS Cat. No.	Contents	Qty. Cs6
29410N	1 Laparotomy Drape with absorbent reinforcement and armboard covers	
9511N	2 AAMI 3 Fabric Reinforced Surgical Gown, Large	
8554N	4 Drape towel, adhesive, nonabsorbent	
8520N	2 Absorbent towel	
8337N	1 Mayo stand cover, reinforced poly, 23 in. (58cm) wide	
8694-60	1 Suture bag	
8146N	1 Outer wrap, reinforced poly table cover, 44 x 90 in. (111.8 x 228.6cm)	

### Laparotomy Pack Sterile No. 29138

NS Cat. No.	Contents	Qty. Cs10
29410N	1 Laparotomy Drape with absorbent reinforcement and armboard covers	
8554N	4 Drape towel, adhesive, nonabsorbent	
8520N	1 Absorbent towel	
8337N	1 Mayo stand cover, reinforced poly, 23 in. (58cm) wide	
8694-60	1 Suture bag	
8146N	1 Outer wrap, reinforced poly table cover, 44 x 90 in. (111.8 x 228.6cm)	

### Laparotomy Pack Sterile No. 29140

NS Cat. No.	Contents	Qty. Cs4
29410N	1 Laparotomy Drape with absorbent reinforcement and armboard covers	
9515NA	1 AAMI 3 NonReinforced Surgical Gown, Large	
8554N	4 Drape towel, adhesive, nonabsorbent	
90270NA	1 AAMI 3 NonReinforced Scrub Nurse Gown, Large, with towel and wrap	
8337N	1 Mayo stand cover, reinforced poly, 23 in. (58cm) wide	
8694-60	1 Suture bag	
8146N	1 Outer wrap, reinforced poly table cover, 44 x 90 in. (111.8 x 228.6cm)	



## Laparotomy Packs

### Laparotomy Pack Sterile No. 29120

NS Cat. No.	Contents	Qty. Cs5
9358N	2 Fan-Folded Drape Sheet, 40 x 57 in. (101 x 145cm)	
29411N	1 Laparotomy Drape, absorbent reinforcement	
8554N	4 Drape towel, adhesive, nonabsorbent	
8520N	1 Absorbent towel	
8337N	1 Mayo stand cover, reinforced poly, 23 in. (58cm) wide	
8694-60	1 Suture bag	
8146N	1 Outer wrap, reinforced poly table cover, 44 x 90 in. (111.8 x 228.6cm)	

### Transverse Laparotomy Pack Sterile No. 29121

NS Cat. No.	Contents	Qty. Cs6
29421N	1 Transverse laparotomy drape, absorbent reinforcement	
9515NA	1 AAMI 3 NonReinforced Surgical Gown, Large	
90270NA	1 AAMI 3 NonReinforced Scrub Nurse Gown, Large, with towel and wrap	
8554N	4 Drape towel, adhesive, nonabsorbent	
8520N	1 Absorbent towel	
8337N	1 Mayo stand cover, reinforced poly, 23 in. (58cm) wide	
8694-60	1 Suture bag	
8146N	1 Outer wrap, reinforced poly table cover, 44 x 90 in. (111.8 x 228.6cm)	

### General Endoscopy Pack Sterile No. 9120

NS Cat. No.	Contents	Qty. Cs6
9458N	1 General Endoscopy Drape	
90270NA	1 AAMI 3 NonReinforced Scrub Nurse Gown, Large, with towel and wrap	
9515NA	2 AAMI 3 NonReinforced Surgical Gown, Large	
8554N	4 Drape towel, adhesive, nonabsorbent	
7148N	10 x-ray detectable sponge, 4 x 4 in. (10.2 x 10.2cm)	
8337N	1 Mayo stand cover, reinforced poly, 23 in.(58cm) wide	
8694-60	1 Suture bag	
8146N	1 Outer wrap, reinforced poly table cover, 44 x 90 in. (111.8 x 228.6cm)	

# Standard packs

## Cardiovascular Packs

### CV Pack Sterile No. 9150

NS Cat. No.	Contents	Qty. Cs4
8694-60	1 Suture bag	
8520N	2 Absorbent towel	
8337N	1 Mayo stand cover, reinforced poly, 23 in. (58cm) wide	
9541N	3 AAMI 3 Fabric Reinforced Surgical Gown, X-Large	
8554N	6 Drape towel, adhesive, nonabsorbent	
9150N	1 CV drape, non-fenestrated	
9349N	1 Fan-Folded Drape Sheet, 52 x 76 in. (132 x 193cm)	
8143N	1 Outer wrap, reinforced poly table cover, 50 x 90 in. (127 x 228.6cm)	

### CV Pack with Reinforced Gowns Sterile No. 29153

NS Cat. No.	Contents	Qty. Cs3
8694-60	1 Suture bag	
8554N	6 Drape towel, adhesive, nonabsorbent	
8520N	1 Absorbent towel	
9040N	2 AAMI 4 Poly Reinforced Surgical Gown, X-Large	
90780N	1 AAMI 4 Poly Reinforced Scrub Nurse Gown, Xlarge, with towel and wrap	
8188N	1 Overhead table cover with sterile extension	
8470N	1 Plastic sheet	
29464N	1 Bottom drape with reinforcement	
29462N	2 Side drapes with tape	
29467N	1 Head drape with reinforcement (on bottom)	
29468N	1 Foot drape with reinforcement (on top)	
9460N	1 Peri-towel	
8143N	1 Outer wrap, reinforced poly table cover, 50 x 90 in. (127 x 228.6cm)	

### CV Split Pack II Sterile No. 29158

NS Cat. No.	Contents	Qty. Cs3
8694-60	1 Suture bag	
8337N	1 Mayo stand cover, reinforced poly, 23 in. (58cm) wide	
9040N	2 AAMI 4 Poly Reinforced Surgical Gown, X-Large	
90680NA	1 AAMI 4 Poly Reinforced Scrub Nurse Gown, Large	
7554N	8 Drape towel with adhesive strip, 19 x 30 in. (48.3 x 76.2cm)	
9158N	1 CV split drape II	
9154N	1 Cardiovascular peri-groin drape, 82 x 75 in. (208.3 x 190.5cm)	
9349N	1 Fan-Folded Drape Sheet, 52 x 76 in. (132 x 193cm)	
8152N	1 Outer wrap/table cover, heavy-duty absorbent, 80 x 110 in. (203.2 x 279.4cm)	

## Cystoscopy Packs

### Cystoscopy Pack Sterile No. 29470

NS Cat. No.	Contents	Qty. Cs10
8694-60	1 Suture bag	
8520N	1 Absorbent towel	
9515NA	1 AAMI 3 NonReinforced Surgical Gown, Large	
8421N	1 Pair of leggings, X-large	
29437NA	1 Cystoscopy T-drape	
8145N	1 Outer wrap, reinforced poly table cover, 44 x 75 in. (111.8 x 190.5cm)	

### Cystoscopy Pack Sterile No. 29471

NS Cat. No.	Contents	Qty. Cs8
8694-60	1 Suture bag	
8520N	1 Absorbent towel	
32474N	1 AAMI 4 Breathable Surgical Gown,X-large, X-long, Specialty	
8421N	1 Pair of leggings, X-large	
29437NA	1 Cystoscopy T-drape	
8145N	1 Outer wrap, reinforced poly table cover, 44 x 75 in. (111.8 x 190.5cm)	

### Cystoscopy Pack Sterile No. 29480

NS Cat. No.	Contents	Qty. Cs14
8694-60	1 Suture bag	
8520N	1 Absorbent towel	
8421N	1 Pair of leggings, X-large	
29437NA	1 Cystoscopy T-drape	
8145N	1 Outer wrap, reinforced poly table cover, 44 x 75 in. (111.8 x 190.5cm)	

### Cystoscopy Pack Sterile No. 29360

NS Cat. No.	Contents	Qty. Cs10
8694-60	1 Suture bag	
8520N	1 Absorbent towel	
29451N	1 Urological Drape	
8145N	1 Outer wrap, reinforced poly table cover, 44 x 75 in. (111.8 x 190.5cm)	

### Cystoscopy Pack Sterile No. 9520E

NS Cat. No.	Contents	Qty. Cs10
8694-60	1 Suture bag	
8421N	1 Pair of leggings, X-large	
9461N	2 Drape Sheet, square-folded, 38.5 x 39.5 in. (97.8 x 100.3cm)	
8145N	1 Outer wrap, reinforced poly table cover, 44 x 75 in. (111.8 x 190.5cm)	

# Standard packs

## Obstetrical Pack

### Obstetrical Pack Sterile No. 29920

NS Cat. No.	Contents	Qty. Cs6
29357N	1 Abdominal Cover with absorbent reinforcement	
8421N	1 Pair of leggings, X-large	
8483N	1 Under-buttocks drape, reinforced poly	
8365N	1 Setup cover, 44 x 71 in. (111.8 x 180.3cm)	
8520N	2 Absorbent towel	
8145N	1 Outer wrap/reinforced poly table cover, 44 x 75 in. (111.8 x 190.5cm), reinforcement 24 x 75 in. (61 x 190.5cm)	

## Head and Neck Packs

### Head and Neck Pack Sterile No. 9194

NS Cat. No.	Contents	Qty. Cs6
9556N	1 Head/Bar Drape, adhesive	
9442N	1 Split Sheet Drape, reinforced, adhesive	
90270NA	1 AAMI 3 NonReinforced Scrub Nurse Gown, Large, with towel and wrap	
9515NA	1 AAMI 3 NonReinforced Surgical Gown, Large	
8554N	2 Drape towel, adhesive, nonabsorbent	
8520N	1 Absorbent towel	
8337N	1 Mayo stand cover, reinforced poly, 23 in. (58cm) wide	
8694-60	1 Suture bag	
8146N	1 Outer wrap, reinforced poly table cover, 44 x 90 in. (111.8 x 228.6cm)	

### Head and Neck Pack Sterile No. 9196

NS Cat. No.	Contents	Qty. Cs6
9556N	1 Head/Bar Drape, adhesive	
9447N	1 Large EENT Split Drape	
90270NA	1 AAMI 3 NonReinforced Scrub Nurse Gown, Large, with towel and wrap	
9515NA	1 AAMI 3 NonReinforced Surgical Gown, Large	
8520N	1 Absorbent towel	
8337N	1 Mayo stand cover, reinforced poly, 23 in. (58cm) wide	
8694-60	1 Suture bag	
8554N	2 Drape towel, adhesive, non-absorbant	
8146N	1 Outer wrap, reinforced poly table cover, 44 x 90 in. (111.8 x 228.6cm)	

## HD Lower Extremity Packs

### HD Lower Extremity Pack Sterile No. 59180

NS Cat. No.	Contents	Qty. Cs6
59405N	1 HD Extremity Drape	
90270NA	1 AAMI 3 NonReinforced Scrub Nurse Gown, Large, with towel and wrap	
32474N	1 AAMI 4 Breathable Surgical Gown,X-large, X-long, Specialty	
8520N	1 Absorbent towel	
8474N	1 Prep U-drape, 60 x 60 in. (152.4 x 152.4cm)	
8476NA	1 Prep U-drape, 60 x 72 in. (152.4 x 182.9cm)	
8694-60	1 Suture bag	
8337N	1 Mayo stand cover, reinforced poly, 23 in. (58cm) wide	
1582N	1 Stockinette, 12 x 48 in. (30.5 x 121.9cm), X-large	
FG71-2384C	1 Tubing, 6mm x 12 ft.	
3524	3 Drape tape	
8186N	1 Outer wrap, reinforced poly table cover, 65 x 90 in. (165.1 x 228.6cm), heavy duty	

### HD Arthroscopy Pack Sterile No. 9197

NS Cat. No.	Contents	Qty. Cs6
59413N	1 HD Arthroscopy Drape	
90270NA	1 AAMI 3 NonReinforced Scrub Nurse Gown, Large, with towel and wrap	
32474N	1 AAMI 4 Breathable Surgical Gown,X-large, X-long, Specialty	
8520N	1 Absorbent towel	
8474N	1 Prep U-drape, 60 x 60 in. (152.4 x 152.4cm)	
8476NA	1 Prep U-drape, 60 x 72 in. (152.4 x 183cm)	
8694-60	1 Suture bag	
8337N	1 Mayo stand cover, reinforced poly, 23 in. (58cm) wide	
1582N	1 Stockinette, 12 x 48 in. (30.5 x 121.9cm), X-large	
FG71-2384C	1 Tubing, 12 ft. x 6mm	
3524	3 Drape tape	
8186N	1 Outer wrap, reinforced poly table cover, 65 x 90 in. (165.1 x 228.6cm), heavy duty	

# Standard packs

## Orthopedic Packs

### General Orthopedic Pack Sterile No. 29181

NS Cat. No.	Contents	Qty. Cs4
29440N	1 Split Drape with absorbent reinforcement, adhesive	
29351N	1 Top Drape with absorbent reinforcement 53 x 99 in. (134.6 x 251.5cm), adhesive	
9040N	2 AAMI 4 Poly Reinforced Surgical Gown, X-Large	
8520N	2 Absorbent towel	
8694-60	1 Suture bag	
8337N	1 Mayo stand cover, reinforced poly, 23 in. (58cm) wide	
8475N	1 U-Drape, poly, adhesive, 60 x 84 in. (152.4 x 213.4cm)	
1582N	1 Stockinette, 12 x 48 in. (30.5 x 121.9cm), X-large	
8554N	4 Drape towel, adhesive, nonabsorbent	
8143N	1 Outer wrap, reinforced poly table cover, 50 x 90 in. (127 x 228.6cm)	

### Orthopedic Pack Sterile No. 29182

NS Cat. No.	Contents	Qty. Cs5
9349N	1 Fan-Folded Drape Sheet, 52 x 76 in. (132 x 193cm)	
29436N	1 Split Drape, adhesive	
8694-60	1 Suture bag	
8337N	1 Mayo stand cover, reinforced poly, 23 in. (58cm) wide	
8476NA	1 Prep U-drape, 60 x 72 in. (152.4 x 182.9cm)	
A8554N	4 Drape towel, adhesive, nonabsorbent	
A8143N	1 Outer wrap, reinforced poly table cover, 50 x 90 in. (127 x 228.6cm)	

## Hand and Hip Packs

### Hand Pack Sterile No. 9419

NS Cat. No.	Contents	Qty. Cs5
29419N	1 Hand Drape	
8694-60	1 Suture bag	
8337N	1 Mayo stand cover, reinforced poly, 23 in. (58cm) wide	
8476NA	1 Prep U-drape, 60 x 72 in. (152.4 x 183cm)	
8143N	1 Outer wrap, reinforced poly table cover, 50 x 90 in. (127 x 228.6cm)	

## Hand and Hip Packs

### Hip Pack Sterile No. 29187

NS Cat. No.	Contents	Qty. Cs6
29430N	1 Hip Drape	
9040N	2 AAMI 4 Poly Reinforced Surgical Gown, X-Large	
8520N	2 Absorbent towel	
8694-60	1 Suture bag	
8337N	1 Mayo stand cover, reinforced poly, 23 in. (58cm) wide	
8475N	1 U-Drape, poly, adhesive, 60 x 84 in. (152.4 x 213.4cm)	
1582N	1 Stockinette, 12 x 48 in., X-large (30.5 x 121.9cm)	
8554N	2 Drape towel, adhesive, nonabsorbent	
8143N	1 Outer wrap, reinforced poly table cover, 50 x 90 in. (127 x 228.6cm)	

## Arthroscopic Packs

### Arthroscopy Pack II for Dropped Leg Procedures Sterile No. 9185

NS Cat. No.	Contents	Qty. Cs6
9414NA	1 Arthroscopy Drape with pouch for dropped leg procedures	
32474N	1 AAMI 4 Breathable Surgical Gown, X-large, X-long, Specialty	
90270NA	1 AAMI 3 NonReinforced Scrub Nurse Gown, Large, with towel and wrap	
8694-60	1 Suture bag	
8337N	1 Mayo stand cover, reinforced poly, 23 in. (58cm) wide	
8476NA	2 Prep U-drape, 60 x 72 in. (152.4 x 183cm)	
1586N	1 Stockinette, 9 x 48 in. (22.9 x 121.9cm), large	
3524	4 Drape Tape	
8143N	1 Outer wrap, reinforced poly table cover, 50 x 90 in. (127 x 228.6cm)	

### Arthroscopy Pack Sterile No. 29180

NS Cat. No.	Contents	Qty. Cs6
29414N	1 Extremity Drape with absorbent reinforcement	
9040N	1 AAMI 4 Poly Reinforced Surgical Gown, X-Large	
8520N	1 Absorbent towel	
8694-60	1 Suture bag	
8337N	1 Mayo stand cover, reinforced poly, 23 in. (58cm) wide	
8476NA	1 Prep U-drape, 60 x 72 in. (152.4 x 183cm)	
1582N	1 Stockinette, 12 x 48 in. (30.5 x 121/9cm), X-large	
8143N	1 Outer wrap, reinforced poly table cover, 50 x 90 in. (127 x 228.6cm)	

# Standard packs

## Arthroscopic Packs

### Arthroscopy Pack Sterile No. 29186

NS Cat. No.	Contents	Qty. Cs6
29414N	1 Extremity Drape with absorbent reinforcement	
32474N	1 AAMI 4 Breathable Surgical Gown,X-large, X-long, Specialty	
90270NA	1 AAMI 3 NonReinforced Scrub Nurse Gown, Large, with towel and wrap	
8694-60	1 Suture bag	
8337N	1 Mayo stand cover, reinforced poly, 23 in. (58cm) wide	
8476NA	2 Prep U-drape, 60 x 72 in. (152.4 x 183cm)	
1586N	1 Stockinette, 9 x 48 in. (22.9 x 121.9cm), large	
3524	4 Drape tape	
8143N	1 Outer wrap, reinforced poly table cover, 50 x 90 in. (127 x 228.6cm)	

## Extremity Packs

### Extremity Pack Sterile No. 29188

NS Cat. No.	Contents	Qty. Cs5
29414N	1 Extremity Drape	
8694-60	1 Suture bag	
8337N	1 Mayo stand cover, reinforced poly, 23 in. (58cm) wide	
8375N	1 Plastic sheet, fan-folded, 44 x 60 in. (111.8 x 152.4cm)	
8554N	2 Drape towel, adhesive, nonabsorbent	
8143N	1 Outer wrap, reinforced poly table cover, 50 x 90 in. (127 x 228.6cm)	

### Extremity Pack Sterile No. 29189

NS Cat. No.	Contents	Qty. Cs6
29414N	1 Extremity drape	
8694-60	1 Suture bag	
9040N	2 AAMI 4 Poly Reinforced Surgical Gown, X-Large	
8520N	1 Absorbent towel	
8337N	1 Mayo stand cover, reinforced poly, 23 in. (58cm) wide	
8375N	1 Plastic sheet, fan-folded, 44 x 60 in. (111.8 x 152.4cm)	
8554N	3 Drape towel, adhesive, nonabsorbent	
8143N	1 Outer wrap, reinforced poly table cover, 50 x 90 in. (127 x 228.6cm)	



## Shoulder Packs

### Fluid Control Shoulder Pack Sterile No. 9183

NS Cat. No.	Contents	Qty. Cs3
9360N	1 Shoulder Drape with attached fluid control pouch, with incise	
9361N	1 Split Drape, poly reinforced, adhesive	
32474N	1 AAMI 4 Breathable Surgical Gown,X-large, X-long, Specialty	
90270NA	1 AAMI 3 NonReinforced Scrub Nurse Gown, Large, with towel and wrap	
8694-60	1 Suture bag	
8337N	1 Mayo stand cover, reinforced poly, 23 in. (58cm) wide	
8554N	4 Drape towel, adhesive, nonabsorbent	
8146N	1 Outer wrap, reinforced poly table cover, 44 x 90 in. (111.8 x 228.6cm)	

### Fluid Control Shoulder Drape Pack Sterile No. 29367

NS Cat. No.	Contents	Qty. Cs10
9360N	1 Shoulder Drape with attached fluid control pouch, with incise	
9361N	1 Split Drape, poly reinforced, adhesive	

### Shoulder Drape Pack Sterile No. 29365

NS Cat. No.	Contents	Qty. Cs8
9361N	1 Split Drape, poly reinforced, adhesive	
29365N	1 Shoulder Drape with incise, adhesive	

### Shoulder Pack Sterile No. 29160

NS Cat. No.	Contents	Qty. Cs3
9361N	1 Split Drape, poly reinforced, adhesive	
29365N	1 Shoulder Drape with incise, adhesive	
32474N	1 AAMI 4 Breathable Surgical Gown,X-large, X-long, Specialty	
90270NA	1 AAMI 3 NonReinforced Scrub Nurse Gown, Large, with towel and wrap	
8520N	1 Absorbent towel	
8694-60	1 Suture bag	
8337N	1 Mayo stand cover, reinforced poly, 23 in. (58cm) wide	
8476NA	1 U-Drape, poly, adhesive, 60 x 72 in. (152.4 x 183cm)	
8554N	4 Drape towel, adhesive, nonabsorbent	
8146N	1 Outer wrap, reinforced poly table cover, 44 x 90 in. (111.8 x 228.6cm)	

# Standard packs

## Pediatric Pack

### Pediatric Pack Sterile No. 29490

NS Cat. No.	Contents	Qty. Cs8
29496N	1 Minor Procedure Drape	
9545NA	2 AAMI 3 NonReinforced Surgical Gown, X-Large	
8520N	2 Absorbent towel	
8337N	1 Mayo stand cover, reinforced poly, 23 in. (58cm) wide	
8694-60	1 Suture bag	
8554N	4 Drape towel, adhesive, nonabsorbent	
8146N	1 Outer wrap, reinforced poly table cover, 44 x 90 in. (111.8 x 228.6cm)	

## Laparoscopy Packs

### Laparoscopy Pack Sterile No. 29242

NS Cat. No.	Contents	Qty. Cs10
29402N	1 Laparoscopy Drape with absorbent reinforcement, adhesive	
8554N	1 Drape towel, adhesive, nonabsorbent	
8520N	1 Absorbent towel	
8421N	1 Pair of leggings, X-large	
8694-60	1 Suture bag	
8146N	1 Outer wrap, reinforced poly table cover, 44 x 90 in. (111.8 x 228.6cm)	

### Laparoscopy Pack Sterile No. 29245

NS Cat. No.	Contents	Qty. Cs8
29402N	1 Laparoscopy Drape with absorbent reinforcement, adhesive	
8483N	1 Under-buttocks drape, reinforced poly	
90270NA	1 AAMI 3 NonReinforced Scrub Nurse Gown, Large, with towel and wrap	
9515NA	1 AAMI 3 NonReinforced Surgical Gown, Large	
8554N	1 Drape towel, adhesive, nonabsorbent	
8520N	1 Absorbent towel	
8421N	1 Pair of leggings, X-large	
8337N	1 Mayo stand cover, reinforced poly, 23 in. (58cm) wide	
8694-60	1 Suture bag	
8146N	1 Outer wrap, reinforced poly table cover, 44 x 90 in. (111.8 x 228.6cm)	

### Laparoscopy/Pelviscopy Pack I Sterile No. 29606

NS Cat. No.	Contents	Qty. Cs10
29404N	1 Laparoscopy/Pelviscopy Drape with gussets, absorbent reinforcement, adhesive	
8483N	1 Under-buttocks drape, reinforced poly	
8421N	1 Pair of leggings, X-large	

## Laparoscopy Packs

### Laparoscopy/Pelviscopy Pack II Sterile No. 29604

NS Cat. No.	Contents	Qty. Cs10
29404N	1 Laparoscopy/Pelviscopy drape with gussets, absorbent reinforcement, adhesive	
8483N	1 Under-buttocks drape, reinforced poly	
8554N	2 Drape towel, adhesive, nonabsorbent	
8421N	1 Pair of leggings, X-large	
8694-60	1 Suture bag	
8337N	1 Mayo stand cover, reinforced poly, 23 in. (58cm) wide	
8146N	1 Outer wrap, reinforced poly table cover, 44 x 90 in. (111.8 x 228.6cm)	

### Laparoscopy/Pelviscopy Pack III Sterile No. 29408

NS Cat. No.	Contents	Qty. Cs10
29407N	1 Laparotomy/Pelviscopy Drape	
8483N	1 Under-buttocks drape, reinforced poly	
8554N	2 Drape towel, adhesive, nonabsorbent	
8421N	1 Pair of leggings, X-large	
8694-60	1 Suture bag	
8337N	1 Mayo stand cover, reinforced poly, 23 in. (58cm) wide	
8146N	1 Outer wrap, reinforced poly table cover, 44 x 90 in. (111.8 x 228.6cm)	

### Fluid Control Laparoscopy Drape Pack Sterile No. 29503

NS Cat. No.	Contents	Qty. Cs10
29403N	1 Laparoscopy Drape	
8421N	1 Pair of leggings, X-large	

### Abdominal Lithotomy Pack Sterile No. 29146

NS Cat. No.	Contents	Qty. Cs8
29300N	1 Abdominal Lithotomy Drape	
8483N	1 Under-buttocks drape, reinforced poly	

# Standard packs

## Peri-GYN and Laparoscopy Packs

### Peri-GYN Pack Sterile No. 29276

NS Cat. No.	Contents	Qty. Cs10
29438N	1 Lithotomy "T" Drape with absorbent reinforcement, adhesive	
8554N	1 Drape towel, adhesive, nonabsorbent	
8520N	1 Absorbent towel	
8421N	1 Pair of leggings, X-large	
8694-60	1 Suture bag	
8146N	1 Outer wrap, reinforced poly table cover, 44 x 90 in. (111.8 x 228.6cm)	

### Peri-GYN Pack Sterile No. 29170

NS Cat. No.	Contents	Qty. Cs12
29450N	1 Lithotomy Drape with absorbent reinforcement, attached leggings	
8483N	1 Under-buttocks drape, reinforced poly	
8554N	1 Drape towel, adhesive, nonabsorbent	
8520N	1 Absorbent towel	
8694-60	1 Suture bag	
8149N	1 Outer wrap/reinforced poly table cover, 44 x 85 in. (111.8 x 215.9cm), reinforcement 24 x 85 in. (61 x 215.9cm)	

### Peri-GYN Pack Sterile No. 29171

NS Cat. No.	Contents	Qty. Cs5
29450N	1 Lithotomy Drape with absorbent reinforcement, attached leggings	
8483N	1 Under-buttocks drape, reinforced poly	
9515NA	1 AAMI 3 NonReinforced Surgical Gown, Large	
8554N	1 Drape towel, adhesive, nonabsorbent	
8520N	1 Absorbent towel	
8694-60	1 Suture bag	
8149N	1 Outer wrap/reinforced poly table cover, 44 x 85 in. (111.8 x 215.9cm), reinforcement 24 x 85 in. (61 x 215.9cm)	

### LAVH/Laparoscopy Pack Sterile No. 29475

NS Cat. No.	Contents	Qty. Cs4
29474N	1 LAVH Drape	
8483N	1 Under-buttocks drape, reinforced poly	
90680NA	1 AAMI 4 Poly Reinforced Scrub Nurse Gown, Large	
9040N	2 AAMI 4 Poly Reinforced Surgical Gown, X-Large	
8694-60	1 Suture bag	
8337N	1 Mayo stand cover, reinforced poly, 23 in. (58cm) wide	
8143N	1 Outer wrap, reinforced poly table cover, 50 x 90 in. (127 x 228.6cm)	

## Peri-GYN and Laparoscopy Packs

### Peri-GYN Pack Sterile No. 9274

NS Cat. No.	Contents	Qty. Cs10
9359N	1 Drape sheet, adhesive 38 1/2 x 56 in. (97.8 x 142.2cm)	
8483N	1 Under-buttocks drape	
8421N	1 Pair of leggings, X-large	
8520N	1 Absorbent towel	
8554N	1 Non-absorbent towel with adhesive strip	
8694-60	1 Suture bag	
9515NA	1 AAMI 3 NonReinforced Surgical Gown, Large	
8146N	1 Table cover, reinforced poly, 44 x 90 in. (111.8 x 228.6cm)	

### Peri-GYN Pack Sterile No. 9165

NS Cat. No.	Contents	Qty. Cs12
9359N	1 Drape sheet, adhesive 38.5 x 56 in. (97.8 x 142.2cm)	
8483N	1 Under-buttocks drape, reinforced poly	
8421N	1 Pair of leggings, X-large	
8520N	1 Absorbent towel	
8554N	1 Non-absorbent towel with adhesive strip	
8694-60	1 Suture bag	
8146N	1 Outer wrap, reinforced poly table cover, 44 x 90 in. (111.8 x 228.6cm)	

# Sterile Number Index

114.....	76	29430.....	54
117.....	76	29431.....	52
1584.....	8	29434.....	52, 65
1585.....	8	29435.....	56
1586.....	8	29436.....	52
1587.....	8	29439.....	54
29013.....	62	29440.....	31, 52
29063.....	58	29442.....	40
29066.....	58	29443.....	40
29107.....	78	29444.....	54
29118.....	79	29445.....	52
29120.....	81	29447.....	40
29121.....	81	29448.....	40
29127.....	79	29449.....	40
29130.....	80	29450.....	70
29131.....	79	29452.....	40
29133.....	79	29455.....	28, 69
29137.....	80	29456.....	14
29138.....	80	29458.....	17
29140.....	80	29459.....	14
29146.....	91	29460.....	14
29153.....	82	29461.....	17
29154.....	21	29470.....	83
29158.....	82	29471.....	83
29160.....	89	29474.....	70
29170.....	92	29475.....	92
29171.....	92	29476.....	52
29180.....	87	29480.....	83
29181.....	86	29490.....	90
29182.....	86	29492.....	65
29186.....	88	29494.....	65
29187.....	87	29496.....	34, 65
29188.....	88	29503.....	91
29189.....	88	29510.....	33
29242.....	90	29520.....	14
29245.....	90	29521.....	16
29276.....	92	29522.....	34
29350.....	7	29525.....	15
29352.....	31, 59	29527.....	25
29360.....	83	29529.....	18
29365.....	89	29556.....	15
29367.....	89	29559.....	26
29369.....	58	29560.....	15
29405.....	56	29570.....	16
29407.....	69	29574.....	70
29408.....	91	29575.....	70
29410.....	33	29604.....	91
29411.....	33	29606.....	90
29414.....	56	29668.....	26
29416.....	56	29920.....	84
29417.....	56	3520.....	6
29418.....	38	3523.....	6
29420.....	34	3524.....	9
29421.....	33	59180.....	85
29422.....	34	59274.....	51
29425.....	33	59352.....	50
29427.....	54	59362.....	51

# Sterile Number Index

59363.....	51
59405.....	50
59413.....	50
59427.....	50
59438.....	50
59439.....	50
74210.....	65
7444.....	43
7445.....	44
7550.....	6
7552.....	6
7553.....	6
7554.....	6
8145W.....	11
8146W.....	11
8186.....	11
8186W.....	11
8337.....	12
8339.....	12
8376.....	11
8377.....	11
8378.....	11
8380.....	11
8385.....	11
8386.....	11
8420.....	8
8421.....	8
8430.....	8
8433.....	8
8441.....	43
8461.....	7
8474.....	8
8475.....	8
8476.....	8
8482.....	7
8483.....	7
8484.....	7
8486.....	7
8487.....	7
8553.....	6
9100.....	76
9101.....	76
9102.....	76
9103.....	77
9106.....	78
9111.....	77
9112.....	77
9113.....	77
9114.....	78
9120.....	81
9131.....	78
9133.....	65
9150.....	82
9153.....	22
9154.....	21
9155.....	21
9156.....	21

9158.....	21
9162.....	21
9165.....	93
9183.....	89
9185.....	87
9194.....	84
9196.....	84
9197.....	85
9274.....	93
9349.....	7
9355.....	7
9358.....	7
9385.....	11
9414.....	54
9418.....	34
9419.....	86
9423.....	54
9428.....	34
9430.....	33
9438.....	35
9439.....	38
9444.....	7
9446.....	7
9447.....	45
9448.....	38
9449.....	38
9450.....	38
9457.....	35
9458.....	35
94590.....	35
9461.....	7
9462.....	7
9464.....	7
9520E.....	83
9556.....	45
9562.....	44
9565.....	44

## C

C2242.....	19
C2289.....	73
C2299.....	73
C2304.....	62
C2312.....	43
C2315.....	25
C2319.....	62
C2324.....	25
C2326.....	10
C2339.....	19
C2346.....	25
C2348.....	73
C2350A.....	44
C2358.....	73
C2362.....	62
C2411.....	19
C2444.....	19

# Sterile Number Index

## D

D1000	6
D1003	10
D1010	6
D1012	12
D1013	12
D1014	60
D1015	8
D1016	10
D1017	60
D1018	9
D1018L	9
D1019	8
D1020	46
D1021	46
D1024	46
D1025	46
D1030	47
D1031	47
D1060	47
D1061	47
D1062	44
D1067	60
D1071	28
D1072	10
D1089	6
D1092	73
D1093	19
D1122	46
D1165	44
D1195	14
D2007	12
D2008A	12
D2019	43
D2021	10
D2029	9
D2043	47
D2057	41
D2114	10
D2147	43
D2158	12
D2221	63
D2224	73
D2244	15
D2258	47
D2264	74
D2286	15
D2288C	16
D2310C	62
D2318C	74
D2344	18
D2355	18

D2361	43
D2364	17
D2366	18
D2399	18
D2422	17
D5510	10
D37104910	9
D37106210	9
D37106310	9
D37106410	9
D37612210	9

## M

M9471	7
MCDC2321	46

## S

SPP99GSUDA	6
------------	---

## T

TB9349CE	7
TB9441	45



# Nonsterile Number Index

1582N	8, 30, 51, 53, 55, 57, 85, 86, 87	9153N	22
1585N	8	9154N	21, 23, 82
1586N	8, 55, 57, 87, 88	9155N	21
2058NS	26	9156N	21
3524	55, 57, 85, 87, 88	9158N	21, 23, 82
3524N	30, 51	9162N	21
7148N	36, 81	9349N	7, 23, 30, 53, 76, 77, 78, 82, 86
7444N	43	9355N	7
7445N	44	9358N	7, 30, 36, 76, 77, 79, 81
7554N	6, 23, 82	9359N	71, 93
8143N	23, 30, 32, 36, 53, 55, 57, 71, 76, 78, 79, 80, 82, 86, 87, 88, 92	9360N	58, 59, 89
8145N	11, 28, 41, 83, 84	9361N	53, 58, 59, 89
8145NW	11	9414NA	54, 55, 87
8146N	11, 30, 32, 36, 48, 59, 66, 71, 76, 77, 78, 79, 80, 81, 84, 89, 90, 91, 92, 93	9418N	34
8146NW	11	9423N	54
8149N	71, 92	9428NA	34
8152N	11, 23, 82	9430N	33
8153N	11	9438N	35
8184N	11	9439N	38
8184NW	11	9441N	45
8186N	11, 30, 51, 76, 78, 85	9442N	45, 48, 84
8186NW	11	9444N	7
8187N	11	9446N	7
8188N	11, 23, 82	9447N	45, 48, 84
8191N	11	9448N	38
8337N	12, 23, 30, 32, 36, 48, 51, 53, 55, 57, 59, 66, 71, 76, 77, 78, 79, 80, 81, 82, 84, 85, 86, 87, 88, 89, 90, 91, 92	9449N	38
8339NI	12	9450N	38
8365N	6, 41, 84	9457N	35
8371NI	11	9458N	35, 36, 81
8375N	57, 88	9460N	6, 23, 82
8420NA	8	9461N	7, 28, 83
8421N	8, 28, 41, 71, 83, 84, 90, 91, 92, 93	9462N	7
8430NA	8	9465N	31, 32, 78
8433N	8	9467N	31, 32, 78
8441N	43	9468N	31, 32, 78
8461N	7	9511N	30, 36, 77, 79, 80
8470N	7, 23, 82	9515NA	28, 30, 32, 36, 48, 71, 76, 77, 78, 80, 81, 83, 84, 90, 92, 93
8474N	8, 51, 85	9541N	23, 82
8475N	8, 53, 55, 86, 87	9545NA	66, 90
8476NA	8, 30, 51, 53, 55, 57, 59, 85, 86, 87, 88, 89	9556N	45, 48, 84
8482N	7	9557N	45
8483N	7, 41, 71, 84, 90, 91, 92, 93	9562N	44
8484N	7	9565N	44
8486N	7	29013N	62
8487N	7	29063N	58
8520N	6, 23, 28, 30, 32, 36, 41, 48, 51, 53, 55, 57, 59, 66, 71, 77, 78, 79, 80, 81, 82, 83, 84, 85, 86, 87, 88, 89, 90, 92, 93	29066N	58
8554N	6, 23, 30, 32, 36, 48, 53, 55, 57, 59, 66, 71, 76, 77, 78, 79, 80, 81, 82, 84, 86, 87, 88, 89, 90, 91, 92, 93	29154N	21
8694-60	23, 28, 30, 32, 36, 48, 51, 53, 55, 57, 59, 66, 71, 76, 77, 78, 79, 80, 81, 82, 83, 84, 85, 86, 87, 88, 89, 90, 91, 92, 93	29194N	31, 32, 79
8750	7	29195N	31, 32, 79
9010N	30, 36, 78, 80	29300N	68, 71, 91
9040N	23, 53, 55, 57, 71, 82, 86, 87, 88, 92	29350N	7
9150N	22, 23, 82	29351N	31, 32, 53, 59, 79, 86
		29357N	41, 84
		29365N	58, 59, 89
		29369NA	58
		29402N	68, 71, 90
		29403N	69, 71, 91

# Nonsterile Number Index

29404N.....	68, 71, 90, 91	29525N.....	15
29405N.....	56	29527N.....	25
29407N.....	69, 71, 91	29529N.....	18
29410N.....	33, 36, 79, 80	29556NA.....	15
29411N.....	36, 81	29557N.....	26
29414N.....	56, 57, 87, 88	29559N.....	26
29416N.....	56	29560N.....	15
29417N.....	56	29570N.....	16
29418N.....	38	29574N.....	70
29419N.....	86	29575N.....	70
29420N.....	34	29663N.....	22, 23
29421N.....	33, 36, 81	29665N.....	31, 32, 79
29422N.....	34	29667N.....	31, 32, 79
29427N.....	54, 55	29668N.....	26
29430N.....	54, 55, 87	29669N.....	31, 32, 79
29431N.....	52	32474N.....	28, 51, 55, 57, 59, 83, 85, 87, 88, 89
29434N.....	52, 65	59274N.....	51
29435N.....	56	59352N.....	50
29436N.....	52, 53, 86	59362N.....	51
29437NA.....	28, 83	59363.....	51
29438N.....	70, 71, 92	59363N.....	51
29439N.....	54	59405N.....	50, 51, 85
29440N.....	53, 86	59413N.....	50, 51, 85
29440NA.....	31, 32, 52, 79	59427N.....	50
29442N.....	40	59438N.....	50
29443N.....	40	59439N.....	50
29444N.....	54	74210N.....	65
29445N.....	52	90270NA.....	30, 32, 36, 48, 51, 55, 57, 59, 71, 76, 77, 78, 80, 81, 84, 85, 87, 88, 89, 90
29447N.....	40	90680NA.....	23, 30, 36, 71, 78, 80, 82, 92
29448N.....	40	90780N.....	23, 82
29449N.....	40	90970N.....	30, 77
29450N.....	70, 71, 92	94590N.....	35
29451N.....	28, 83		
29452N.....	40		
29453N.....	41	<b>A</b>	
29455N.....	69	A8143N.....	86
29455NA.....	28	A8554N.....	86
29456N.....	14		
29458N.....	17	<b>C</b>	
29459N.....	14	C2290NS.....	74
29460N.....	14	C2299NS.....	73
29462N.....	22, 23, 82	C2304NS.....	62
29464N.....	22, 23, 82	C2312NS.....	43
29465NA.....	31, 32, 78	C2315NS.....	25
29467N.....	22, 23, 31, 32, 78, 82	C2319NS.....	62
29468N.....	22, 23, 82	C2324NS.....	25
29469N.....	31, 32, 78	C2325NS.....	62
29474N.....	70, 71, 92	C2326NS.....	10
29476N.....	52	C2346NS.....	25
29478N.....	59	C2362NS.....	62
29492N.....	65	C2411NS.....	19
29494N.....	65	C2433NS.....	18
29496.....	90		
29496N.....	34, 65, 66		
29510N.....	33		
29520N.....	14		
29521N.....	16		
29522N.....	34		

# Nonsterile Number Index

## D

D1000NS.....	6
D1003NS.....	10
D1010NS.....	6
D1012NS.....	12
D1013NS.....	12
D1014NS.....	60
D1015NS.....	8
D1016NS.....	10
D1017NS.....	60
D1018LNS.....	9
D1018NS.....	9
D1019NS.....	8
D1020NS.....	46
D1021NS.....	46
D1024NS.....	46
D1025NS.....	46
D1030NS.....	47
D1031NS.....	47
D1060NS.....	47
D1061NS.....	47
D1062NS.....	44
D1067NS.....	60
D1071NS.....	28
D1072NS.....	10
D1089NS.....	6
D1092NS.....	73
D1165NS.....	44
D1195NS.....	14
D1495NS.....	14
D2007NS.....	12
D2008NS.....	12
D2019NS.....	43
D2021NS.....	10
D2029NS.....	9
D2043NS.....	47
D2057NS.....	41
D2114NS.....	10
D2158NS.....	12
D2221NS.....	63
D22.....	

# Product Index

## B

### Bags

Isolation Bags.....	10
---------------------	----

## C

### Covers

Abdominal Cover .....	41
Equipment Covers.....	12
Heavy-Duty Back Table Covers .....	11
Mayo Stand Covers .....	12
Standard Back Tables Covers.....	11

## D

### Drapes

#### Ancillary

Drape Sheets.....	7
Drape Sheet, Square-Folded .....	7
Drape Sheets with Adhesive .....	7
Drape Towels.....	6
Poly U-Drapes .....	8
Under-Buttocks Drapes.....	7
Wound Protectors .....	9

#### Ancillary: Drape Accessories

Adhesives and Drape Tape.....	9
Equipment Covers.....	12
Heavy-Duty Back Table Covers .....	11
Isolation Bags.....	10
Leggings .....	8
Mayo Stand Covers .....	12
Pouches .....	9-10
Standard Back Tables Covers.....	11
Stockinettes.....	8

#### Angiography

Angiography Sheet.....	14-16
Brachial Angiography Drape .....	17
Extra Large Femoral Angiography Drape .....	16
Femoral Angiography Drape.....	14
Femoral Angiography Drape with Catheter Pouch.....	14
Femoral Angiography Drape with Dual Pouches .....	16
Femoral Angiography Drape with Expanded Reinforcement.....	15
Femoral Angiography Drape with Single Pouch .....	15
Femoral Angiography Drape with Trough .....	15
Lulu Radial/Femoral Angio Sheet.....	18
Moveable Multiaccess IR Sheet.....	19
Moveable Radial/Femoral Angio Sheet.....	18
Multiaccess IR Sheet.....	19
Neonatal Angio Sheet .....	19
Orlando Radial/Femoral Angio Sheet .....	18
Pediatric Angiography Sheet .....	19
Pediatric/Neonatal Angio Drape.....	19
Radial/Brachial Drape .....	17
Radial/Femoral Angiography Drape.....	18
Radial/Femoral Angiography Sheet .....	18

### Drapes, continued

#### Cardiovascular

Bottom Drape with Reinforcement .....	22
Cardiovascular Drape.....	22
Cardiovascular Incise Drape .....	21
Cardiovascular Peri-Groin Drape .....	21
Cardiovascular Split Drape.....	21
Cardiovascular Split Drape with Pouches.....	21
Cardiovascular Split Drape with Troughs .....	21
CV Universal Drape Pack.....	22
Head, Side and Foot Drapes .....	22

#### Central line

Central Line Drape .....	25
Central Line Sheet.....	25
Dressing Change Pouch Organizer .....	26
Full Body Central Line Drape.....	25
Jugular Sheet .....	25
Line Insertion Drape.....	26
Line Insertion Draping System .....	26
PICC Line Insertion Drape .....	26

#### Cystoscopy

Cystoscopy "T" Drape.....	28
Lithotomy Drape with Fluid Control Pouch.....	28
Urological Drape.....	28

#### General Surgery

Adolescent Laparotomy Drape .....	34
Bariatric Drape.....	35
Basic Packs .....	30
Chest/Breast Drape.....	34
General Endoscopy Drape .....	35
General Endoscopy Pack .....	36
Laparoscopic Abdominal Drape .....	35
Laparoscopic Cholecystectomy Drape with Pouches.....	34
Laparotomy Drape .....	33
Laparotomy Drape with Pouches.....	33
Laparotomy Incise Drape .....	33
Laparotomy Packs .....	36
Major Abdominal Drape with Pouches .....	35
Minor Procedure Drape.....	34
Pfannenstiel Laparotomy Drape.....	33
Setup Packs .....	30
Thyroid Drape.....	34
Transverse Laparotomy Drape.....	33
Universal Packs.....	31-32
Universal Split Pack.....	31

#### Neurosurgery

Craniotomy Drape.....	38
Craniotomy Split Drape.....	38
Neurological Drape .....	38
Universal Spine Drape .....	38

#### Obstetrics

Abdominal Cover .....	41
Cesarean Birth Drape.....	40-41
Cesarean Birth Drape with Dual Layer Anesthesia Screen .....	40
Cesarean Pouch .....	41
Obstetrical Pack.....	41

## Drapes, continued

### Ophthalmology and EENT

Aperture Drape.....	43-44, 46-47
Bar Drape.....	45
Blepharoplasty Drape.....	43
EENT Split Drape.....	45
Eye Drape with Pouch.....	44
Head and Neck Packs.....	48
Head/Bar Drape.....	45
Large EENT Split Drape.....	45
Ophthalmic Aperture Drape.....	46-47
Ophthalmic Drape.....	43-44
Ophthalmic Drape with Pouch.....	44
Ophthalmic Incise Drape.....	43-44, 46-47
Ophthalmic Incise Pouch.....	46
Ophthalmic Incise Sheet.....	44
Refractive Drape.....	46
Small Drape with Adhesive Aperture.....	43
Strabismus Drape.....	47

### Orthopedics

Arthroscopy Drape for Dropped Leg Procedures.....	54
Arthroscopy Drape with Armboard Covers.....	54
Arthroscopy Hand and Hip Packs.....	55
Beach Chair Shoulder Drape.....	58
Beach Chair Shoulder Drape.....	58
Beach Chair Shoulder Drape with Attachable Pouch.....	58
Bilateral Limb Drape.....	56
Extremity Drape.....	56
Extremity Drape with Armboard Covers.....	56
Extremity Packs.....	57
General Ortho Packs.....	53
Hand Drape.....	54
Hip Drape.....	54
Hip Drape with Pouches.....	54
Orthopedic Split Drape.....	52
Patient Isolation Drape.....	60
Shoulder Drape.....	58
Shoulder Packs.....	59
Shoulder Pouch.....	60
Split Drape.....	52-53, 58
Split Sheet Drape.....	52
Top Drape.....	59

### Orthopedics - Heavy Duty

HD Arthroscopy Drape.....	50
HD Dual Split Shoulder Drape.....	51
HD Extremity Drape.....	50
HD Hand Drape.....	50
HD Hip Drape with Pouches.....	50
HD Packs.....	51
HD Shoulder Drape with Pouch.....	51
HD Split Drape.....	50-51
HD Top Drape.....	50

### Pacemaker

Fluoroscope Procedure Sheet.....	63
Pacemaker Angiography Sheet.....	62
Pacemaker Drape.....	62
Pacemaker Sheet.....	62

## Drapes, continued

### Pediatrics

Circumcision Drape.....	65
Minor Procedure Drape.....	65
Neonatal Drape.....	65
Pediatric Directional Incision Drape.....	65
Pediatric Drape.....	65
Pediatric Pack.....	66
Split Drape.....	65

### Peri-GYN

Abdominal Lithotomy Drape.....	68
Laparoscopy Drape.....	68-69
Laparoscopy/Pelviscopy Drape.....	68-69
LAVH Drape.....	70
Lithotomy Drape.....	69-70
Lithotomy "T" Drape.....	70
Peri-GYN Packs.....	71
Robotic Drape.....	70
Robotic Drape with Attached Leggings.....	70

### Special procedures

Epidural Drape.....	73
Fistula Drape.....	74
Fistula Drape with Window.....	74
Fistula Sheet.....	74
Minor Procedure Drape.....	73
Small Aperture Drape.....	73
Special Procedure Drape.....	73
Special Procedure Sheet.....	73

## L

### Leggings

Leggings.....	8
---------------	---

## P

### Packs

Abdominal Lithotomy Pack.....	91
Arthroscopy Hand and Hip Packs.....	55
Arthroscopy Pack.....	87-88
Arthroscopy Pack II for Dropped Leg Procedures.....	87
Basic Packs.....	30, 76-78
Cardiovascular Packs.....	23, 82
Cardiovascular Pack with Reinforced Gowns.....	82
Cardiovascular Split Pack II.....	82
Cystoscopy Packs.....	28, 83
Extremity Packs.....	57, 88
Fluid Control Laparoscopy Drape Pack.....	91
Fluid Control Shoulder Drape Pack.....	89
Fluid Control Shoulder Pack.....	89
General Endoscopy Pack.....	36, 81
General Ortho Packs.....	53
General Orthopedic Pack.....	86
Hand Pack.....	86
HD Arthroscopy Pack.....	85
HD Lower Extremity Pack.....	85
Head and Neck Packs.....	48, 84

# Product Index

## Packs, continued

Heavy Duty Packs .....	51
Hip Pack .....	87
Laparoscopy Packs .....	90
Laparoscopy/Pelviscopy Pack I.....	90
Laparoscopy/Pelviscopy Pack II.....	91
Laparoscopy/Pelviscopy Pack III .....	91
Laparotomy Packs .....	36, 79-81
LAVH/Laparoscopy Pack .....	92
Obstetrical Packs .....	41, 84
Orthopedic Pack .....	86
Pediatric Packs .....	66, 90
Peri-GYN Packs .....	71, 92-93
Setup Packs.....	30, 76
Shoulder Drape Pack.....	89
Shoulder Packs .....	59, 89
Transverse Laparotomy Pack.....	81
Universal Packs.....	31-32, 78-79
Universal Split Packs.....	31, 79
Universal Split Pack II .....	79

## Pouches

Pouches.....	9-10
Shoulder Pouch.....	60

## S

### Stockinettes

Stockinettes.....	8
-------------------	---

## T

### Tape

Adhesives and Drape Tape.....	9
-------------------------------	---

## W

### Wound Protectors

Wound Protectors .....	9
------------------------	---





VELCRO is a registered trademark of Velcro Industries.

© 2016 Cardinal Health. All Rights Reserved. CARDINAL HEALTH, the Cardinal Health LOGO and ESSENTIAL TO CARE are trademarks or registered trademarks of Cardinal Health. All other marks are the property of their respective owners. Lit. No. 2PER115-384917 (06/2016) PRC (06/2016)

[cardinalhealth.com](http://cardinalhealth.com)

Cardinal Health  
Waukegan, Illinois